

TSPL/TSPL2 Programming Language

TSC BAR CODE PRINTER SERIES

PROGRAMMING MANUAL

TABLE OF CONTENTS

How to Read.....	VI
Document Conventions.....	VII
Object Position Calculation	VIII
Printer Model List.....	X
Setup and System Commands	1
<input type="checkbox"/> SIZE.....	1
<input type="checkbox"/> GAP	2
<input type="checkbox"/> GAPDETECT	4
<input type="checkbox"/> BLINEDETECT.....	5
<input type="checkbox"/> AUTODETECT.....	6
<input type="checkbox"/> BLINE.....	7
<input type="checkbox"/> OFFSET	8
<input type="checkbox"/> SPEED	9
<input type="checkbox"/> DENSITY.....	11
<input type="checkbox"/> DIRECTION AND MIRROR IMAGE	12
<input type="checkbox"/> REFERENCE.....	13
<input type="checkbox"/> SHIFT	14
<input type="checkbox"/> COUNTRY	16
<input type="checkbox"/> CODEPAGE.....	17
<input type="checkbox"/> CLS.....	19
<input type="checkbox"/> FEED	20
<input type="checkbox"/> BACKFEED & BACKUP	21
<input type="checkbox"/> FORMFEED.....	22
<input type="checkbox"/> HOME.....	23
<input type="checkbox"/> PRINT	24
<input type="checkbox"/> SOUND	25
<input type="checkbox"/> CUT.....	26
<input type="checkbox"/> LIMITFEED	27
<input type="checkbox"/> SELFTEST	28
<input type="checkbox"/> EOJ	30
<input type="checkbox"/> DELAY	31
<input type="checkbox"/> DISPLAY	32
<input type="checkbox"/> INITIALPRINTER.....	34
<input type="checkbox"/> MENU.....	35
Label Formatting Commands	37
<input type="checkbox"/> BAR.....	37
<input type="checkbox"/> BARCODE.....	38
<input type="checkbox"/> TLC39	44
<input type="checkbox"/> BITMAP	45
<input type="checkbox"/> BOX	47
<input type="checkbox"/> CIRCLE	48
<input type="checkbox"/> ELLIPSE	49
<input type="checkbox"/> CODABLOCK F MODE.....	50
<input type="checkbox"/> DMATRIX	51
<input type="checkbox"/> ERASE	53
<input type="checkbox"/> MAXICODE	54
<input type="checkbox"/> PDF417	56
<input type="checkbox"/> AZTEC	59
<input type="checkbox"/> MPDF417	60
<input type="checkbox"/> PUTBMP	61
<input type="checkbox"/> PUTPCX	63
<input type="checkbox"/> QRCODE	65
<input type="checkbox"/> RSS	71

<input type="checkbox"/>	REVERSE	75
<input type="checkbox"/>	DIAGONAL.....	76
<input type="checkbox"/>	TEXT	77
<input type="checkbox"/>	BLOCK.....	80
Status Polling and Immediate Commands		83
<input type="checkbox"/>	<ESC>!P	83
<input type="checkbox"/>	<ESC>!C.....	84
<input type="checkbox"/>	<ESC>!D	85
<input type="checkbox"/>	<ESC>!O	86
<input type="checkbox"/>	<ESC>!P.....	87
<input type="checkbox"/>	<ESC>!Q	88
<input type="checkbox"/>	<ESC>!R.....	89
<input type="checkbox"/>	<ESC>!S	90
<input type="checkbox"/>	<ESC>!F	92
<input type="checkbox"/>	<ESC>!.....	93
<input type="checkbox"/>	~!@	94
<input type="checkbox"/>	~!A	95
<input type="checkbox"/>	~!C.....	96
<input type="checkbox"/>	~!D	97
<input type="checkbox"/>	~!E.....	98
<input type="checkbox"/>	~!F.....	99
<input type="checkbox"/>	~!I.....	100
<input type="checkbox"/>	~!T.....	101
<input type="checkbox"/>	<ESC> Y.....	102
<input type="checkbox"/>	<ESC> Z.....	103
Message Translation Protocols.....		104
<input type="checkbox"/>	~#	104
Commands for Windows Driver		105
<input type="checkbox"/>	!B.....	105
<input type="checkbox"/>	!J	106
<input type="checkbox"/>	!N	107
File Management Commands		108
<input type="checkbox"/>	DOWNLOAD	108
<input type="checkbox"/>	EOP.....	111
<input type="checkbox"/>	FILES.....	112
<input type="checkbox"/>	KILL.....	113
<input type="checkbox"/>	MOVE	115
<input type="checkbox"/>	RUN	116
BASIC Commands and Functions		117
<input type="checkbox"/>	ABS().....	117
<input type="checkbox"/>	ASC().....	118
<input type="checkbox"/>	CHR\$()	119
<input type="checkbox"/>	XOR\$()	120
<input type="checkbox"/>	END	121
<input type="checkbox"/>	EOF().....	122
<input type="checkbox"/>	OPEN	123
<input type="checkbox"/>	CLOSE	125
<input type="checkbox"/>	WRITE.....	126
<input type="checkbox"/>	READ	127
<input type="checkbox"/>	SEEK	128
<input type="checkbox"/>	LOF()	129
<input type="checkbox"/>	LOC().....	130
<input type="checkbox"/>	FREAD\$()	131
<input type="checkbox"/>	PUT.....	132
<input type="checkbox"/>	GET.....	133

<input type="checkbox"/>	COPY.....	134
<input type="checkbox"/>	FOR...NEXT LOOP.....	135
<input type="checkbox"/>	WHILE...WEND	136
<input type="checkbox"/>	DO...LOOP	137
<input type="checkbox"/>	IF...THEN...ELSE...ENDIF LOOP	140
<input type="checkbox"/>	GOSUB...RETURN.....	143
<input type="checkbox"/>	GOTO.....	144
<input type="checkbox"/>	INP\$()	145
<input type="checkbox"/>	INP()	146
<input type="checkbox"/>	LOB().....	147
<input type="checkbox"/>	INPUT	148
<input type="checkbox"/>	PREINPUT	149
<input type="checkbox"/>	POSTINPUT.....	150
<input type="checkbox"/>	SET FILTER ON/OFF.....	151
<input type="checkbox"/>	REM.....	152
<input type="checkbox"/>	OUT	153
<input type="checkbox"/>	OUTR	154
<input type="checkbox"/>	GETKEY().....	155
<input type="checkbox"/>	INT().....	156
<input type="checkbox"/>	LEFT\$().....	157
<input type="checkbox"/>	LEN().....	158
<input type="checkbox"/>	MID\$()	159
<input type="checkbox"/>	RIGHT\$()	160
<input type="checkbox"/>	STR\$()	161
<input type="checkbox"/>	STRCOMP()	162
<input type="checkbox"/>	INSTR ().....	163
<input type="checkbox"/>	TRIM\$().....	164
<input type="checkbox"/>	LTRIM\$()	165
<input type="checkbox"/>	RTRIM\$()	166
<input type="checkbox"/>	TEXTPIXEL()	167
<input type="checkbox"/>	BARCODEPIXEL().....	168
<input type="checkbox"/>	VAL()	169
<input type="checkbox"/>	BEEP	170
<input type="checkbox"/>	NOW\$()	171
<input type="checkbox"/>	NOW.....	172
<input type="checkbox"/>	FORMAT\$()	173
<input type="checkbox"/>	DATEADD()	177
<input type="checkbox"/>	FSEARCH()	179
<input type="checkbox"/>	TOUCHPRESS()	180
<input type="checkbox"/>	RECORDSET\$()	181
<input type="checkbox"/>	LABELRATIO.....	183

Device Reconfiguration Commands..... 184

<input type="checkbox"/>	SET COUNTER.....	184
<input type="checkbox"/>	SET CUTTER	185
<input type="checkbox"/>	SET PARTIAL_CUTTER	186
<input type="checkbox"/>	SET BACK	187
<input type="checkbox"/>	SET KEYn.....	188
<input type="checkbox"/>	SET LEDn.....	190
<input type="checkbox"/>	SET PEEL	192
<input type="checkbox"/>	SET REWIND	193
<input type="checkbox"/>	SET TEAR & SET STRIPER.....	194
<input type="checkbox"/>	SET GAP	195
<input type="checkbox"/>	SET BLINE	197
<input type="checkbox"/>	SET HEAD.....	198
<input type="checkbox"/>	SET RIBBON	199
<input type="checkbox"/>	SET ENCODER.....	200

<input type="checkbox"/>	SET RIBBONEND	201
<input type="checkbox"/>	SET COM1.....	202
<input type="checkbox"/>	SET PRINTKEY	203
<input type="checkbox"/>	SET REPRINT	205
<input type="checkbox"/>	SET FEED_LEN	206
<input type="checkbox"/>	GETSENSOR()	207
<input type="checkbox"/>	GETSETTING\$().....	210
<input type="checkbox"/>	SET USBHOST	213
<input type="checkbox"/>	SET RS232_REWINDER	214
<input type="checkbox"/>	SET AUTORUN	215
<input type="checkbox"/>	SET VERIFIER.....	216
<input type="checkbox"/>	SET RESPONSE.....	217
<input type="checkbox"/>	SET DAYLIGHT_SAVE.....	219
<input type="checkbox"/>	PEEL.....	220
<input type="checkbox"/>	LED1, LED2, LED3.....	221
<input type="checkbox"/>	KEY1, KEY2, KEY3	223
Printer Global Variables		225
<input type="checkbox"/>	@LABEL.....	225
<input type="checkbox"/>	YEAR.....	226
<input type="checkbox"/>	MONTH	227
<input type="checkbox"/>	DATE	228
<input type="checkbox"/>	WEEK.....	229
<input type="checkbox"/>	HOUR	230
<input type="checkbox"/>	MINUTE.....	231
<input type="checkbox"/>	SECOND.....	232
<input type="checkbox"/>	@YEAR	233
<input type="checkbox"/>	@MONTH	234
<input type="checkbox"/>	@DATE	235
<input type="checkbox"/>	@DAY	236
<input type="checkbox"/>	@HOUR.....	237
<input type="checkbox"/>	@MINUTE	238
<input type="checkbox"/>	@SECOND.....	239
<input type="checkbox"/>	_MODEL\$.....	240
<input type="checkbox"/>	_SERIAL\$	241
<input type="checkbox"/>	_VERSION\$.....	242
Wi-Fi Module Setting Commands		243
<input type="checkbox"/>	WLAN OFF	243
<input type="checkbox"/>	WLAN SSID	244
<input type="checkbox"/>	WLAN WPA.....	245
<input type="checkbox"/>	WLAN WEP	246
<input type="checkbox"/>	WLAN DHCP	247
<input type="checkbox"/>	WLAN IP	248
<input type="checkbox"/>	WLAN PORT.....	249
Internal Ethernet Setting Commands		250
<input type="checkbox"/>	NET DHCP	250
<input type="checkbox"/>	NET IP	251
<input type="checkbox"/>	NET PORT	252
<input type="checkbox"/>	NET NAME.....	253
NFC Setting Commands.....		254
<input type="checkbox"/>	NFC FEATURE.....	254
<input type="checkbox"/>	NFC STATUS	255
<input type="checkbox"/>	NFC TIMEOUT.....	256
<input type="checkbox"/>	NFC READ	257
<input type="checkbox"/>	NFC WRITE	258
<input type="checkbox"/>	NFC MODE.....	259

Alpha-2R Setting Commands	260
<input type="checkbox"/> SET PRINTQUALITY	260
<input type="checkbox"/> SET STANDBYTIME	261
<input type="checkbox"/> GETSETTING\$().....	262
GPIO Setting Commands	263
<input type="checkbox"/> SET GPO	263
<input type="checkbox"/> SET GPI	265
Update History	1

How to Read

● **MPDF417**

The command name

Description

This command defines a Micro PDF 417 bar code.

Description of this command

Syntax

MPDF417 x, y, rotate, [Wn,][Hn,][Cn],"content"

Syntax of this command

<u>Parameter</u>	<u>Description</u>
x	Horizontal start position (in dots)
y	Vertical start position (in dots)
rotate	Rotation 0 : No rotation 90 : Rotate 90 degrees 180 : Rotate 180 degrees 270 : Rotate 270 degrees
Wn	Optional. Module width in dot. Default is 1.
Hn	Optional. Module height in dot. Default is 10.
Cn	Optional. Number of columns. Once the parameter is set, the printer will calculate the proper rows for the barcode base on the content automatically. 0: Auto mode. 1: Column is 1 and the calculated suitable rows will be 11, 14, 17, 20, 24, and 28. 2: Column is 2 and the calculated suitable rows will be 8, 11, 14, 17, 20, 23 and 26. 3: Column is 3 and the calculated suitable rows will be 6, 8, 10, 12, 15, 20, 26, 32, 38 and 44. 4: Column is 4 and the calculated suitable rows will be 4, 6, 8, 10, 12, 15, 20, 26, 32, 38 and 44.
"content"	Content of Micro PDF 417 bar code

Note:
This command has been supported since V6.61 EZ and later firmware.

The detail description of each parameter

Example

Sample Code

```

SIZE 4,1
GAP 0,0
CLS
MPDF417 10,10,0,"ABCDEFGHJKLMNOPQRSTUVWXYZ0123456789"
MPDF417 110,10,0,W2,"ABCDEFGHJKLMNOPQRSTUVWXYZ0123456789"
MPDF417 210,10,0,W2,H3,"ABCDEFGHJKLMNOPQRSTUVWXYZ0123456789"
MPDF417 310,10,0,W2,H3,C3,"ABCDEFGHJKLMNOPQRSTUVWXYZ0123456789"
PRINT 1
          
```

Result



The example and printout for reference

Document Conventions

This manual uses the following typographic conventions.

Convention	Description
[expression list]	Items inside square brackets are optional, expression maximum length 2*1024 bytes.
<ESC>	ASCII 27, control code of status polling command returns/runs the printer status immediately.
~	ASCII 126, control code of status polling command returns the printer status only when the printer is ready.
Space	ASCII 32, characters will be ignored in the command line.
"	ASCII 34, beginning and ending of expression.
CR, LF	ASCII 13, ASCII 10, denotes end of command line.
NULL	ASCII 0, supported in the expression.
Note: <i>203 DPI: 1 mm = 8 dots</i>	The font in bold and italic type is used for note.

Object Position Calculation

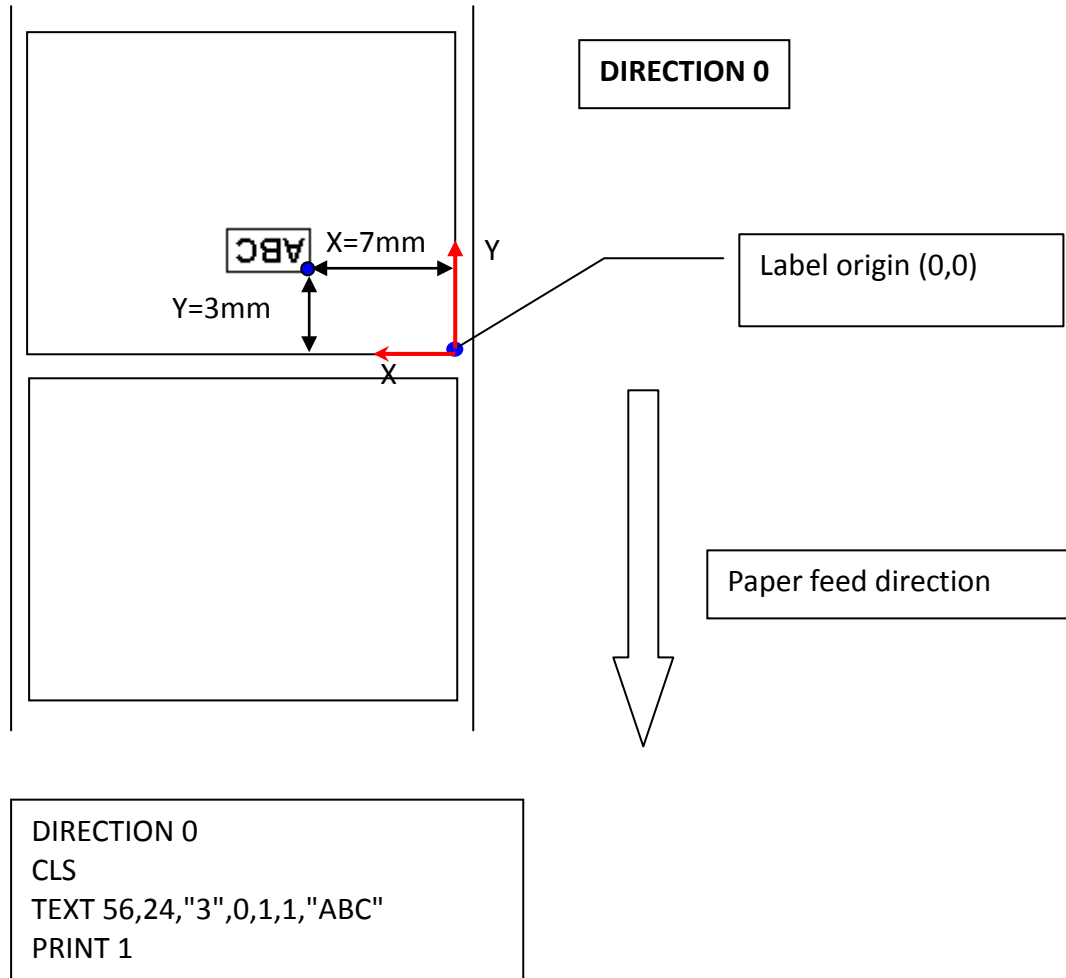

Note :

- 1. 203 DPI, 1mm=8 dots ; 300 DPI, 1mm=11.8 dots**
- 2. Only integer portion will be used. Ex. 2 mm = 23.6 dots then 23 dots will be used.**

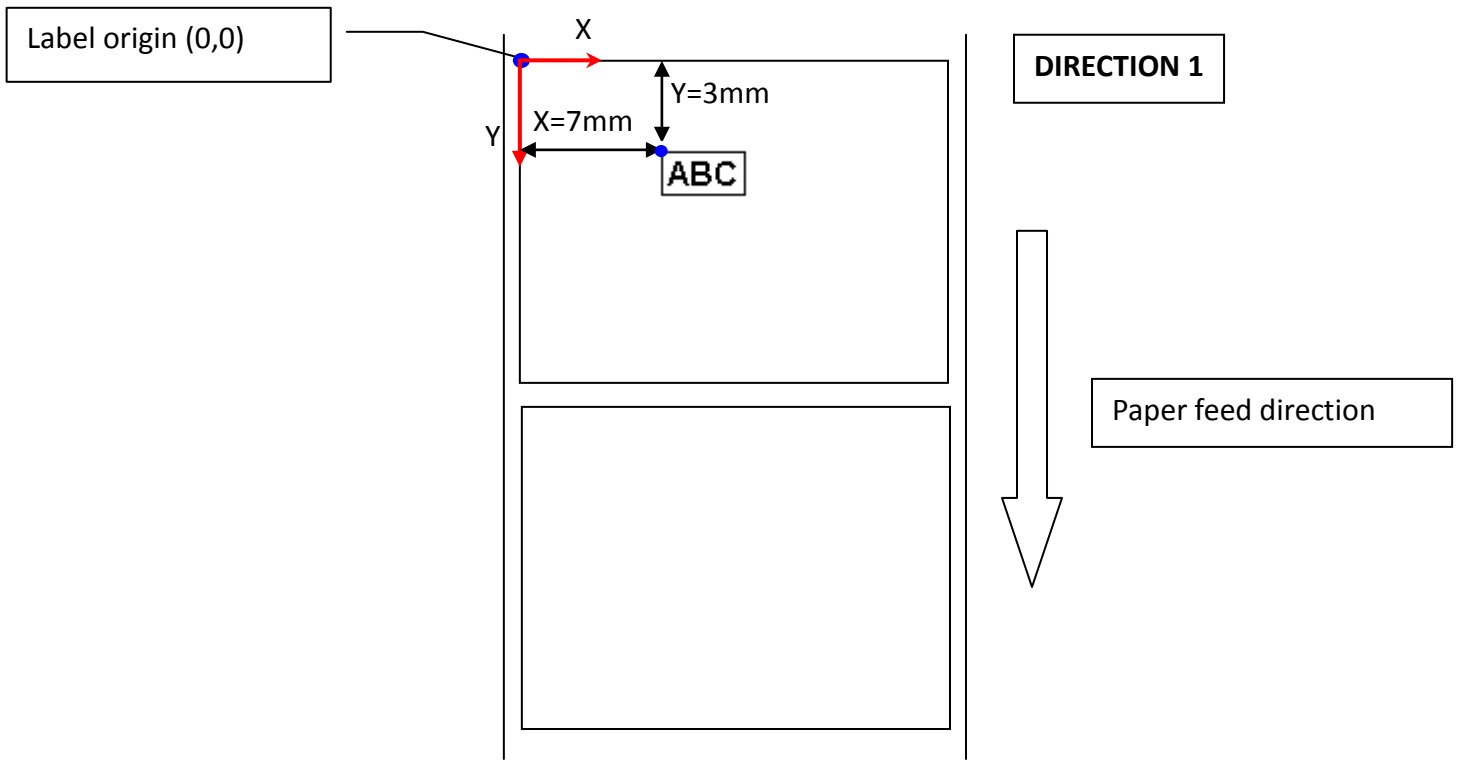

```

DIRECTION 1
CLS
TEXT 56,24,"3",0,1,1,"ABC"
PRINT 1

```

Printer Model List

Series	Models	Support Programming	F/W Version	F/W Maintainability
TDP-643 Plus	TDP-643 Plus	TSPL	V x.x	No
TTP-243 series	TTP-243, TTP-243E, TTP-342	TSPL	V x.x	No
TTP-244ME series	TTP-243M, TTP-244ME, TTP-342M	TSPL	V x.x	No
TDP-245 series	TDP-245, TDP-245G	TSPL2	V x.x	No
TTP-245 series	TTP-245, TTP-245G, TTP-343	TSPL2	V x.x	No
TTP-246M series	TTP-246M, TTP-246G, TTP-344M	TSPL2	V x.x	No
TTP-248M series	TTP-248M	TSPL2	V x.x	No
TDP-643R Plus	TDP-643R Plus	TSPL	V x.x	No
TTP-243 Plus series	TTP-243 Plus, TTP-243E Plus, TTP-342 Plus	TSPL	V x.x	No
TTP-244ME Plus	TTP-244ME Plus, TTP-342M Plus	TSPL	V x.x	No
TTP-2410M series TTP-246M Plus series	TTP-2410M, TTP-346M, TTP-644M TTP-246M Plus, TTP-344M Plus	TSPL2	V x.x	No
TTP-244 series	TTP-244	TSPL2	V x.x	No
M23 series	M23	TSPL2	V x.x	No
TTP-244 Plus series	TTP-244 Plus	TSPL2	V x.x	No
TA200 series	TA200, TA300	TSPL2	V x.x	No
TTP-245C series	TTP-245C, TTP-343C	TSPL2	V x.x	No
TTP-2410M Pro series	TTP-2410M Pro, TTP-346M Pro, TTP-644M Pro	TSPL2	V x.x	No
TTP-268M series	TTP-268M, TTP-366M	TSPL2	V x.x	No
TTP-384M series	TTP-384M	TSPL2	V x.x	No
TTP-243 Pro series	TTP-243 Pro, TTP-243E Pro, TTP-342 Pro	TSPL	V x.x	Yes
TTP-244 Pro series	TTP-244 Pro	TSPL2	V x.x	Yes
TDP-247 series	TDP-245 Plus, TDP-244, TDP-247, TDP-345	TSPL2	V x.x	Yes
DA200 series	DA200, DA300	TSPL2	A x.x	Yes
TTP-247 series	TTP-245 Plus, TTP-343 Plus, TTP-247, TTP-345	TSPL2	V x.x	Yes
TE200 series	TE200, TE300	TSPL2	A x.x	Yes
TX200 series	TX200, TX300, TX600	TSPL2	A x.x	Yes
TDP-225 series	TDP-225, TDP-324, TDP-225W, TDP-324W	TSPL2	V x.x	Yes
TTP-225 series	TTP-225, TTP-323	TSPL2	V x.x	Yes
TTP-244CE	TTP-244CE	TSPL2	V x.x	Yes
TC200 series	TC200, TC300, TC210, TC310	TSPL2	A x.x	Yes
TA210 series	TA210, TA310	TSPL2	V x.x	Yes
TTP-244M Pro	TTP-244M Pro, TTP-244ME Pro,	TSPL2	V x.x	Yes

series	TTP-342M Pro, TTP-342ME Pro			
ME240 series	ME240, ME340	TSPL2	V x.x	Yes
TTP-246M Pro series	TTP-246M Pro, TTP-344M Pro	TSPL2	V x.x	Yes
TTP-2410MU series TTP-2410MT series	TTP-2410MU, TTP-346MU, TTP-644MU, TTP-2410MT, TTP-346MT, TTP-644MT	TSPL2	A x.x	Yes
MX240 series	MX240, MX340, MX640	TSPL2	A x.x	Yes
MX240P series	MX240P, MX340P, MX640P	TSPL2	A x.x	Yes
MH240 series	MH240, MH340, MH640, MH240T, MH340T, MH640T, MH240P, MH340P, MH640P	TSPL2	A x.x	Yes
TTP-2610M series	TTP-2610MT, TTP-368MT	TSPL2	A x.x	Yes
TTP-286MT series	TTP-286MT, TTP-384MT	TSPL2	A x.x	Yes
Alpha-2R series	Alpha-2R	TSPL2	A x.x	Yes
Alpha-3R series	Alpha-3R	TSPL2	V x.x	Yes
Alpha-4L series	Alpha-4L	TSPL2	V x.x	Yes

The commands listed in the TSPL2 programming manual are included in all printer models firmware. The printer may not support the related commands if the function is not included in the printer specification.

Setup and System Commands

● SIZE

Description

This command defines the label width and length.

Syntax

SIZE m[,n]	English system (inch)
SIZE m mm[,n mm]	Metric system (mm)
SIZE m dot[,n dot]	Dot measurement <i>This command has been supported since V6.27 EZ and later firmware.</i>

<u>Parameter</u>	<u>Description</u>
M	Label width (inch/ mm/ dot)
[N]	Label length (inch/ mm/ dot); <i>This item can be optional since V8.13 & A2.10 and later firmware.</i>

Note :

- **200 DPI : 1 mm = 8 dots**
- **300 DPI : 1mm = 12 dots**
- **For metric and dot systems, there must be a space between parameter and “mm” or “dot”.**

Example

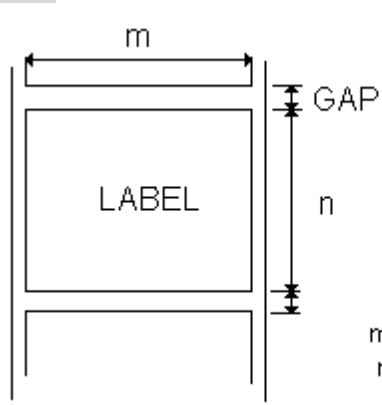
<u>Sample Code</u>	<u>Result</u>
<ul style="list-style-type: none">▪ English system (inch): SIZE 3.5,3.00▪ Metric system (mm): SIZE 100 mm,100 mm	 <p>m: Label Width n: Label Height</p>

See Also

GAP, BLINE

● GAP

Description

Defines the gap distance between two labels.

Syntax

GAP m,n	English system (inch)
GAP m mm,n mm	Metric system (mm)
GAP m dot,n dot	Dot measurement <i>This command has been supported since V6.27 EZ and later firmware.</i>

<u>Parameter</u>	<u>Description</u>
M	The gap distance between two labels $0 \leq m \leq 1$ (inch), $0 \leq m \leq 25.4$ (mm) $0 \leq m \leq 5$ (inch), $0 \leq m \leq 127$ (mm) / <i>since V6.21 EZ and later firmware</i>
N	The offset distance of the gap $n \leq \text{label length}$ (inch or mm)
0, 0	Continuous label

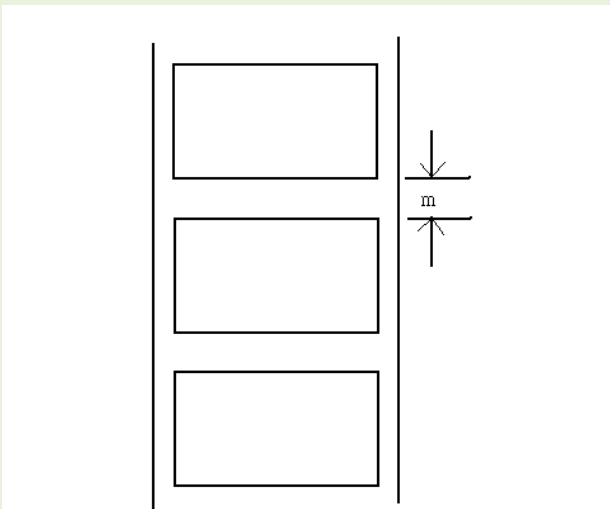
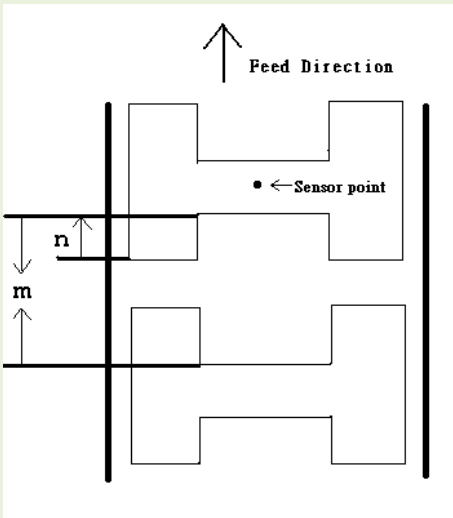
Note :

- **200 DPI : 1 mm = 8 dots**
- **300 DPI : 1mm = 12 dots**
- **For metric and dot systems, there must be a space between parameter and mm.**
- **When the sensor type is changed from "Black Mark" to "GAP", please send the "GAP" command to the printer first.**

Example

Sample Code	Result
<p>Normal gap</p> <ul style="list-style-type: none"> ▪ English system (inch): GAP 0.12,0 ▪ Metric system (mm): GAP 3 mm,0 mm ▪ Continuous label: GAP 0,0 	<p>Normal gap</p>  <p>The diagram shows three rectangular labels stacked vertically. To the right of the labels, a vertical line indicates the gap between them. A double-headed arrow labeled 'm' indicates the distance between the top and bottom edges of the labels.</p>
<p>Special gap</p> <ul style="list-style-type: none"> ▪ English system (inch) GAP 0.30,0.10 ▪ Metric system (mm) GAP 7.62 mm,2.54 mm 	<p>Special gap</p>  <p>The diagram shows a complex label layout with a central horizontal bar and two vertical bars on the sides. An arrow labeled 'Feed Direction' points upwards. A dot labeled 'Sensor point' is located on the central bar. Dimensions 'n' and 'm' are indicated with arrows. 'n' is the distance from the top edge of the central bar to the top edge of the label above it. 'm' is the distance from the bottom edge of the central bar to the bottom edge of the label below it.</p>

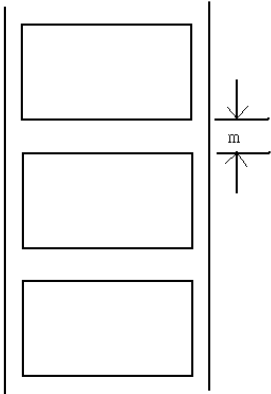
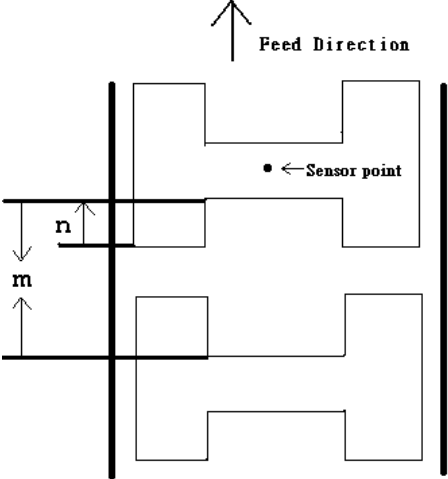
See Also

SIZE, BLINE

● GAPDETECT

Description

This command feeds the paper through the gap sensor in an effort to determine the paper and gap sizes, respectively. This command references the user's approximate measurements. If the measurements conflict with the actual size, the GAPDETECT command will not work properly. This calibration method can be applied to the labels with pre-printed logos or texts.

Syntax

GAPDETECT [x,y]

<u>Parameter</u>	<u>Description</u>
X	Paper length (in dots)
Y	Gap length (in dots)

Note:

If the x, y parameters are ignored then the printer will calibrate and determine the paper length and gap size automatically.

See Also

GAP, SIZE, BLINEDETECT, AUTODETECT

● BLINEDETECT

Description

This command feeds the paper through the black mark sensor in an effort to determine the paper and black mark sizes, respectively. This command references the user's approximate measurements. If the measurements conflict with the actual size, the BLINEDETECT command will not work properly. This calibration method can be applied to the labels with pre-printed logos or texts.

Syntax

BLINEDETECT [x,y]

<u>Parameter</u>	<u>Description</u>
x	Paper length (in dots)
y	Gap length (in dots)

Note:
If the x, y parameters are ignored then the printer will calibrate and determine the paper length and gap size automatically.

See Also

GAP, SIZE, GAPDETECT, AUTODETECT

● AUTODETECT

Description

This command feeds the paper through the gap/black mark sensor in an effort to determine the paper and gap/black mark sizes, respectively. This command references the user's approximate measurements. If the measurements conflict with the actual size, the AUTODETECT command will not work properly. This calibration method can be applied to the labels with pre-printed logos or texts.

Syntax

AUTODETECT [x,y]

<u>Parameter</u>	<u>Description</u>
x	Paper length (in dots)
y	Gap length (in dots)

Note:

- *If the x, y parameters are ignored then the printer will calibrate and determine the paper length and gap/black mark size automatically.*
- *When using this command, the printer will detect the label by the proper sensor type so please don't set the command GAP or BLINE in your program.*
- *It is supported in firmware V6.86 EZ or later.*

See Also

GAP, SIZE, GAPDETECT, BLINEDETECT

● BLINE

Description

This command sets the height of the black line and the user-defined extra label feeding length each form feed takes.

Syntax

BLINE m,n	English system (inch)
BLINE m mm,n mm	Metric system (mm)
BLINE m dot,n dot	Dot measurement

This command has been supported since V6.27 EZ and later firmware.

<u>Parameter</u>	<u>Description</u>
m	The height of black line either in inch or mm $0 \leq m \leq 1$ (inch), $0 \leq m \leq 25.4$ (mm) $0 \leq m \leq 5$ (inch), $0 \leq m \leq 127$ (mm) / since V6.21 EZ and later firmware
n	The extra label feeding length $0 \leq n \leq \text{label length}$
0,0	Continuous label

The diagram shows a vertical rectangular label. At the top, a blue arrow points to the 'Leading edge'. Below it, a vertical dimension line labeled 'm' indicates the height of a thick black horizontal bar. A downward arrow labeled 'Feed Direction' is in the center. Another thick black horizontal bar is shown below a gap. A vertical dimension line labeled 'n' indicates the height of this gap. A second 'Black line' label points to the bottom bar. At the bottom, a blue wavy line represents the label's edge.

Note:

- For metric system, there must be a space between parameter and mm.
- When the sensor type is changed from "GAP" to "Black Mark", please send the "BLINE" command to the printer first.
- 200 DPI : 1 mm = 8 dots
300 DPI : 1mm = 12 dots

Example

<u>Sample Code</u>
<ul style="list-style-type: none"> ▪ English system (inch): BLINE 0.20,0.50 ▪ Metric system (mm): BLINE 5.08 mm,12.7 mm

See Also

SIZE, GAP

● OFFSET

Description

This command defines the selective, extra label feeding length each form feed takes, which, especially in peel-off mode and cutter mode, is used to adjust label stop position, so as for label to register at proper places for the intended purposes. The printer back tracks the extra feeding length before the next run of printing.

Syntax

OFFSET m	English system (inch)
OFFSET m mm	Metric system (mm)
OFFSET m dot	Dot measurement
<i>This command has been supported since V6.27 EZ and later firmware.</i>	

<u>Parameter</u>	<u>Description</u>
m	The offset distance (inch or mm) $-1 \leq m \leq 1$ (inch)

CAUTION:

- *Improperly offset value may cause paper jam.*
- *For metric system, there must be a space between parameter and mm.*
- *200 DPI : 1 mm = 8 dots*
- *300 DPI : 1mm = 12 dots*

Example

Sample Code

- English system (inch):
OFFSET 0.5
- Metric system (mm):
OFFSET 12.7 mm

See Also

SIZE, GAP, SET PEEL, SET CUTTER

● SPEED

Description

This command defines the print speed.

Syntax

SPEED n

<u>Parameter</u>	<u>Description</u>																				
n	Printing speed in inch per second																				
Model / IPS	1	1.5	2	2.5	3	3.5	4	5	6	7	8	9	10	11	12	13	14	15	16	17	18
TDP-643 Plus/ TDP-643R Plus series		V	V		V																
TTP-243I/ TTP-243I Plus/ TTP-243I Pro series		V	V		V																
TTP-342/ TTP-342 Plus/ TTP-342I Pro series	V	V	V																		
TTP-244/ TTP-244 Plus series			V		V		V														
TTP-244 Pro series			V		V		V	V													
TDP-244 series			V		V		V														
TDP-245/ TDP-245 Plus/ TTP-245/ TTP-245 Plus series			V		V		V	V													
TDP-247/ TTP-247 series			V		V		V	V	V	V											
TTP-343/ TTP-343 Plus series			V		V																
TDP-345/ TTP-345 series			V		V		V	V													
TTP-244CE/ TTP-343C series			V		V		V														
TTP-245C series/ TE200 series			V		V		V	V	V												
TA200/ DA300 series			V		V		V														
TA210/ DA200 series/ TE300 series			V		V		V	V													
TA300 series		V	V		V																
TA310 series		V	V		V		V														
TX200 series			V		V		V	V	V	V	V										
TX300 series		V	V		V		V	V	V												
TX600 series	V	V	V		V		V														
TDP-225/ TTP-225 series			V		V		V	V													
TDP-324/TDP-324W series			V		V		V														
TTP-323			V		V																
TTP-246M series			V		V		V	V	V												
TTP-246M Plus/ TTP-246M Pro series			V		V		V	V	V	V	V										
TTP-248M series							V	V	V		V										
TTP-2410M/TTP-2410M Pro series			V		V		V	V	V	V	V	V	V	V	V						
TTP-244ME/ TTP-244ME Plus/ TTP-244MI Pro series		V	V		V		V														
TTP-342M/ TTP-342M Plus/ TTP-342M Pro series	V	V	V																		
TTP-344M series			V		V		V														
TTP-344M Plus/ TTP-344M Pro series			V		V		V	V	V												
TTP-346M/ TTP-346M Pro series			V		V		V	V	V	V	V										
TTP-644M/ TTP-246M Pro series	V		V		V		V														
TTP-268M series			V		V		V	V	V	V	V										
TTP-366M series			V		V		V	V	V												
TTP-286MT series			V		V		V	V	V												
TTP-384M/ TTP-384MT series			V		V		V														
ME240 series			V		V		V	V	V												
ME340 series		V	V		V		V														
MX240P series			V		V		V	V	V	V	V	V	V	V	V	V	V	V	V	V	V

● DENSITY

Description

This command sets the printing darkness.

Syntax

DENSITY n

<u>Parameter</u>	<u>Description</u>
n	0~15 0: specifies the lightest level 15: specifies the darkest level

Note:

Default DENSITY setting is 8.

Example

Sample code

```
DENSITY 7
```

● DIRECTION and Mirror Image

Description

This command defines the printout direction and mirror image. This will be stored in the printer memory.

Syntax

DIRECTION n[,m]

<u>Parameter</u>	<u>Description</u>
n	0 or 1. Please refer to the illustrations below
m	0: Print normal image 1: Print mirror image <small>(Note: TDP-643 Plus , TTP-243, TTP-342, TTP-244ME, TTP-342M and TTP-248M series are not supported this mirror feature)</small>

DIRECTION 0,0
Feed Direction
↓
TEST PRINT

DIRECTION 1,0
TEST PRINT
Feed Direction
↓

DIRECTION 0,1
Feed Direction
↓
TEST PRINT

DIRECTION 1,1
TEST PRINT
Feed Direction
↓

Example

Sample code

- **DIRECTION 0**

- **DIRECTION 0,1**

See Also

REFERENCE

● REFERENCE

Description

This command defines the reference point of the label. The reference (origin) point varies with the print direction, as shown:

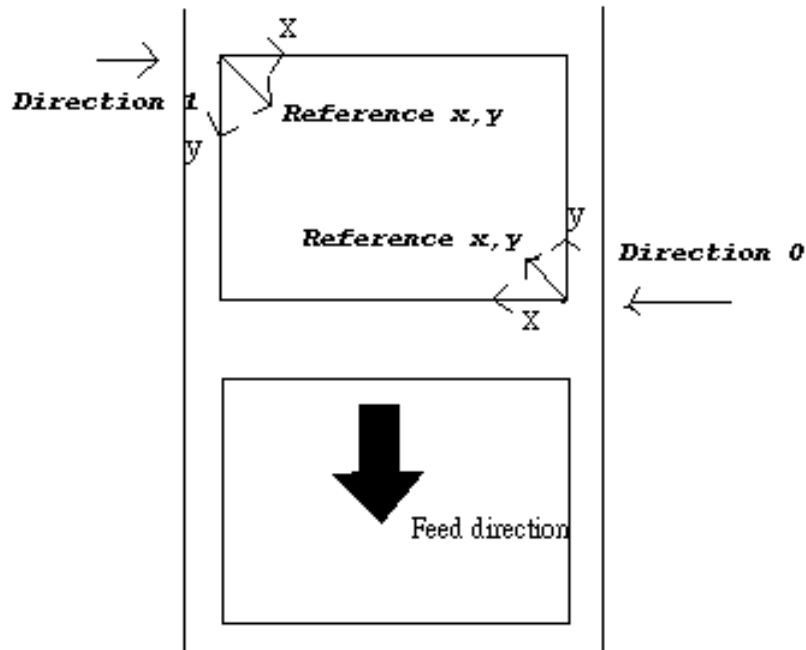

Syntax

REFERENCE *x, y*

<u>Parameter</u>	<u>Description</u>
<i>x</i>	Horizontal coordinate (in dots)
<i>y</i>	Vertical coordinate (in dots)

Note:

200 DPI: 1 mm = 8 dots

300 DPI: 1 mm = 12 dots

Example

Sample code

```
REFERENCE 10,10
```

See Also

DIRECTION

● SHIFT

Description

This command moves the label's horizontal and vertical position. A positive value moves the label further from the printing direction; a negative value moves the label towards the printing direction.

Syntax

SHIFT [x,] y

Parameter	Description
x	Optional. The maximum value is 1 inch. For 200 dpi printers, the range is -203 to 203; for 300 dpi printers, the range is -300 to 300. The unit is dot.
Y	The maximum value is 1 inch. For 200 dpi printers, the range is -203 to 203; for 300 dpi printers, the range is -300 to 300. The unit is dot.

(Note: TDP-643 Plus , TTP-243, TTP-342, TTP-244ME, TTP-342M, TTP-248M and M23 series are not supported this feature)

Example

Sample Code

```

SIZE 4,2.5
GAP 2 mm,0
DIRECTION 0
SHIFT 36
OFFSET 0
CLS
TEXT 400,200, "3",0,1,1, "DIRECTION 0"
TEXT 400,250, "3",0,1,1, "SHIFT 36"
BOX 10,0,780,490,8
PRINT 3,1
        
```

Result

The result shows a 2x3 grid of label examples. The top row shows 'DIRECTION 0' text at two different vertical positions (top and bottom) for three different horizontal shifts: 0, 36, and -36. The bottom row shows 'DIRECTION 1' text at two different vertical positions for the same three horizontal shifts. A red arrow on the right points downwards, labeled 'Printing Direction'.

See Also

OFFSET, REFERENCE

● COUNTRY

Description

This command orients the keyboard for use in different countries via defining special characters on the KP-200 series portable LCD keyboard (option).

Syntax

COUNTRY n

<u>Parameter</u>	<u>Description</u>
n	001: USA
	002: Canadian-French
	003: Spanish (Latin America)
	031: Dutch
	032: Belgian
	033: French (France)
	034: Spanish (Spain)
	036: Hungarian
	038: Yugoslavian
	039: Italian
	041: Switzerland
	042: Slovak
	044: United Kingdom
	045: Danish
	046: Swedish
	047: Norwegian
	048: Polish
	049: German
	055: Brazil
	061: English (International)
	351: Portuguese
	358: Finnish

Example

Sample Code

```
COUNTRY 001
```

See Also

CODEPAGE, ~!!

● CODEPAGE

Description

This command defines the code page of international character set.

Syntax

CODEPAGE n

<u>Parameter</u>		<u>Description</u>					
n		Name or number of code page, which can be divided into 7-bit code page and 8-bit code page.					
7-bit code page		8-bit code page		Windows code page		ISO code page	
n	Name	n	Name	n	Name	n	Name
USA	USA	437	United States	1250	Central Europe	8859-1	Latin 1
BRI	British	737	Greek	1251	Cyrillic	8859-2	Latin 2
GER	German	850	Multilingual	1252	Latin I	8859-3	Latin 3
FRE	French	851	Greek 1	1253	Greek	8859-4	Baltic
DAN	Danish	852	Slavic	1254	Turkish	8859-5	Cyrillic
ITA	Italian	855	Cyrillic	1255	Hebrew	8859-6	Arabic
SPA	Spanish	857	Turkish	1256	Arabic	8859-7	Greek
SWE	Swedish	860	Portuguese	1257	Baltic	8859-8	Hebrew
SWI	Swiss	861	Icelandic	1258	Vietnam	8859-9	Turkish
		862	Hebrew	932	Japanese Shift-JIS	8859-10	Latin 6
		863	Canadian/French	936	Simplified Chinese GBK	8859-15	Latin 9
		864	Arabic	949	Korean		
		865	Nordic	950	Traditional Chinese Big5		
		866	Russian	UTF-8	UTF 8		
		869	Greek 2				

Note:
DATA LENGTH determines 7-bit or 8-bit communications parameter.

Example

Download the COUR.TTF into printer by DiagTool

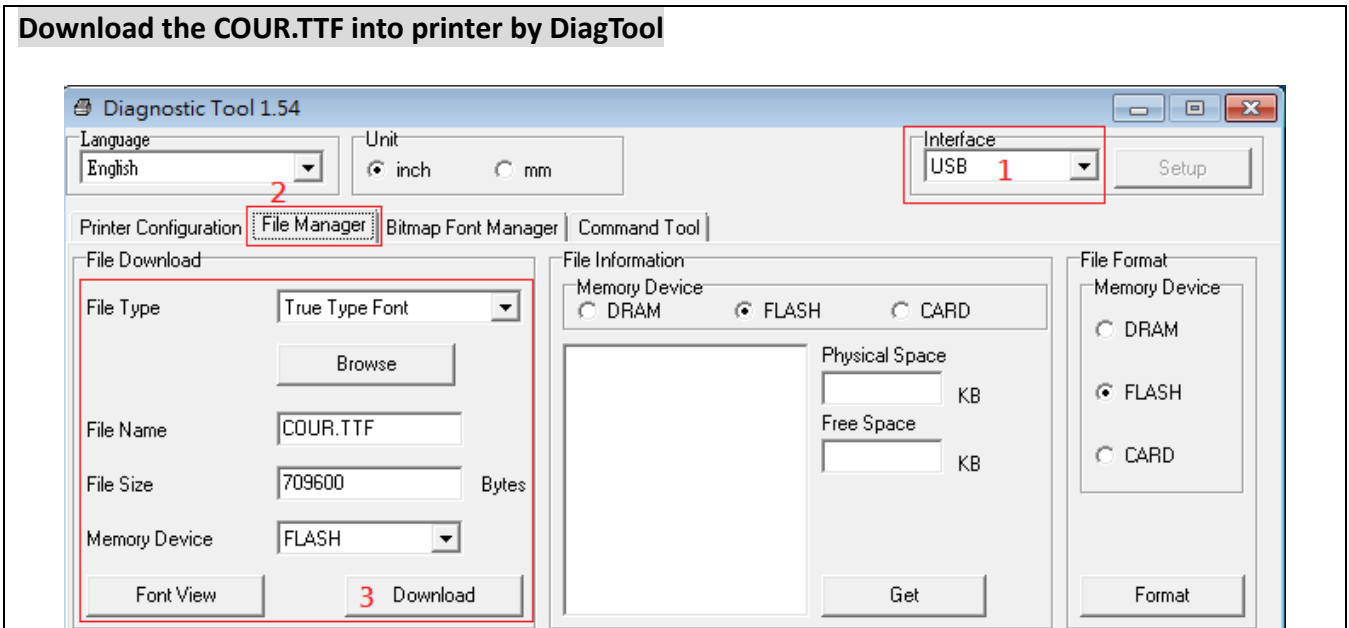

Sample Code	Result
<pre> DOWNLOAD "TEST.BAS" str1\$ = " " J = 0 y = 50 CODEPAGE 1252 SIZE 4,3 GAP 0,0 DIRECTION 1 CLS TEXT 10,10,"COUR.TTF",0,12,12,"CODEPAGE 1252" FOR I=32 TO 255 str1\$=str1\$+CHR\$(I) + " " J=J+1 IF J=16 THEN GOSUB drawTEXT NEXT PRINT 1 END drawTEXT: TEXT 10,y,"COUR.TTF",0,12,12,str1\$ str1\$=" " J=0 y=y+40 RETURN EOP TEST </pre>	<pre> CODEPAGE 1252 ! " # \$ % & ' () * + , - . / 0 1 2 3 4 5 6 7 8 9 : ; < = > ? @ A B C D E F G H I J K L M N O P Q R S T U V W X Y Z [\] ^ _ ` a b c d e f g h i j k l m n o p q r s t u v w x y z { } ~ € , f " ... † ‡ ^ % Š < Œ Ž \ / " " • - - ~ ™ š > œ ž Ÿ ı ç £ ¤ ¥ ¦ § ¨ © ª « ¬ - ® ¯ ° ± ² ³ ´ µ ¶ · ¸ ¹ º » ¼ ½ ¾ ¿ À Á Â Ã Ä Å Æ Ç È É Ê Ë Ì Í Î Ï Ð Ñ Ò Ó Ô Õ Ö × Ø Ù Ú Û Ü Ý Þ ß à á â ã ä å æ ç è é ê ë ì í î ï ð ñ ò ó ô õ ö ÷ ø ù ú û ü ý þ ÿ </pre>

See Also

COUNTRY, ~!l

● CLS

Description

This command clears the image buffer.

Syntax

CLS

<u>Parameter</u>	<u>Description</u>
None	N/A

Note:
This command must be placed after SIZE command.

Example

Sample code

```
CLS
```

See Also

SIZE, GAP, BLINE

● FEED

Description

This command feeds label with the specified length. The length is specified by dot.

Syntax

FEED n

<u>Parameter</u>	<u>Description</u>
n	unit: dot $1 \leq n \leq 9999$

Note:
200 DPI: 1 mm = 8 dots
300 DPI: 1 mm = 12 dots

Example

<u>Sample code</u>
FEED 40

See Also

BACKFEED, SIZE, GAP, BLINE, HOME, FORMFEED

● BACKFEED & BACKUP

Description

This command feeds the label in reverse. The length is specified by dot.

Syntax

BACKUP n	TSPL printers only
BACKFEED n	TSPL2 printers only

Note: Please refer to [printer model list](#) for checking TSPL or TSPL2.

<u>Parameter</u>	<u>Description</u>
n	unit: dot $1 \leq n \leq 9999$

Note:
200 DPI: 1 mm = 8 dots
300 DPI: 1 mm = 12 dots

CAUTION:
Improprity back feed value may cause paper jam or wrinkle.

Example

Sample code
• TSPL printers BACKUP 40
• TSPL2 printers BACKFEED 40

See Also

FEED, SIZE, GAP, BLINE, HOME, FORMFEED

● FORMFEED

Description

This command feeds label to the beginning of next label.

Syntax

FORMFEED

<u>Parameter</u>	<u>Description</u>
None	N/A

Note:
This command must be placed after SIZE command.

Example

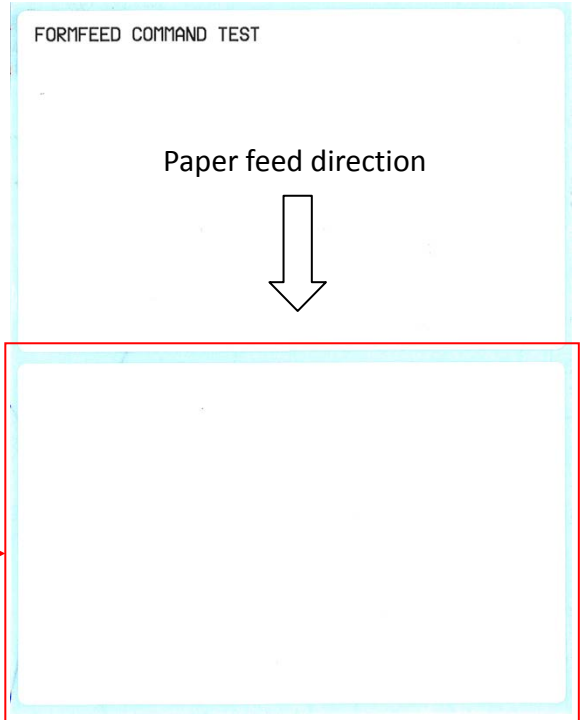
Sample code	Result
<pre>SIZE 4,2.5 GAP 2 mm,0 DIRECTION 1 FORMFEED CLS TEXT 25,25, "3",0,1,1, "FORMFEED COMMAND TEST" PRINT 1,1</pre>	

See Also

FEED, SIZE, GAP, BLINE, HOME, BACKFEED

● HOME

Description

This command will feed label until the internal sensor has determined the origin. Size and gap of the label should be defined before using this command.

Syntax

HOME

<u>Parameter</u>	<u>Description</u>
None	N/A
For TSPL programming printer: Back label to origin position For TSPL2 programming printer: Feed label to origin position	
Note: Please refer to printer model list for checking TSPL or TSPL2.	

Example

Sample code

```
SIZE 4,2.5
GAP 2 mm,0
SET COUNTER @0 +1
@0="000001"
HOME
CLS
BOX 1,1,360,65,12
TEXT 25,25, "3",0,1,1, "HOME COMMAND TEST"
TEXT 25,80, "3",0,1,1,@0
PRINT 3,1
```

See Also

FEED, SIZE, GAP, BLINE, FORMFEED

● PRINT

Description

This command prints the label format currently stored in the image buffer.

Syntax

PRINT m[,n]

<u>Parameter</u>	<u>Description</u>
m	Specifies how many sets of labels will be printed. $1 \leq m \leq 999999999$
n	Specifies how many copies should be printed for each particular label set. $1 \leq n \leq 999999999$

Example

<u>Sample code</u>	<u>Result</u>
<pre>SIZE 50 mm,25 mm GAP 3 mm,0 DIRECTION 1 SET COUNTER @1 1 @1="0001" CLS TEXT 10,10, "3",0,1,1,@1 PRINT 3,2</pre>	<p>0003 0003 0002 0002 0001 0001</p> <p>1 set, 2 copies</p> <p>Paper feed direction ↓</p>

See Also

SET COUNTER, INPUT, DOWNLOAD

● SOUND

Description

This command controls the sound frequency of the beeper. There are 10 levels of sounds. The timing control can be set by the "interval" parameter.

Syntax

SOUND level,interval

<u>Parameter</u>	<u>Description</u>
level	Sound level: 0~9
interval	Sound interval: 1~4095

Example

Sample code

- **SOUND 5,200**
- **SOUND 3,200**
- **SOUND 3,200**
- **SOUND 4,200**
- **SOUND 2,200**
- **SOUND 2,200**
- **SOUND 1,200**
- **SOUND 2,200**
- **SOUND 3,200**
- **SOUND 4,200**
- **SOUND 5,200**

● CUT

Description

This command activates the cutter to immediately cut the labels without back feeding the label.

Syntax

CUT

<u>Parameter</u>	<u>Description</u>
None	N/A

Example

Sample code

```
SIZE 3,3  
GAP 0,0  
CLS  
BOX 0,0,866,866,5  
TEXT 100,100, "5",0,1,1, "FEED & CUT"  
TEXT 100,200, "5",0,1,1, "300 DPI"  
PRINT 1,1  
FEED 260  
CUT
```

See Also

SET CUTTER, SET BACK, SET PARTIAL_CUTTER

● LIMITFEED

Description

If the gap sensor is not set to a suitable sensitivity while feeding labels, the printer will not be able to locate the correct position of the gap. This command stops label feeding and makes the red LED flash if the printer does not locate gap after feeding the length of one label plus one preset value.

Syntax

LIMITFEED n[,minpaper,maxgap]	English system (inch)
LIMITFEED n mm[,minpaper mm,maxgap mm]	Metric system (mm)
LIMITFEED n dot[,minpaper dot,maxgap dot]	Dot measurement <i>This command has been supported since V6.34 EZ.</i>

<u>Parameter</u>	<u>Description</u>
N	The maximum length for sensor detecting
Minpaper	The minimum length of paper
Maxgap	The maximum length of gap

Note:

- *The setting will remain resident in memory.*
- *For metric system, there must be a space between parameter n and mm.*
- *The default value is 10 inches when printer initializes.*
- *Since V6.76 EZ, the default value for TDP-225 series printer is 14 inches when printer initializes.*
- *The setting of parameters "mimpaper" and "maxgap" are using for calibrating the preprinted label. This parameter has been supported since V6.98.7 EZ.*

Example

Sample code
• English system (inch) LIMITFEED 12

● SELFTEST

Description

At this command, the printer will print out the printer information.

Syntax

SELFTEST [page]

<u>Parameter</u>	<u>Description</u>
page	<p>omitted: Print a self-test page with whole printer information.</p> <p>PATTERN: Print a pattern to check the status of print head heat line.</p> <p>ETHERNET: Print a self-test page with Ethernet settings.</p> <p>WLAN: Print a self-test page with Wi-Fi settings.</p> <p>RS232: Print a self-test page with RS-232 settings.</p> <p>SYSTEM: Print a self-test page with printer settings.</p> <p>Z: Print a self-test page with emulated language settings.</p>

Example

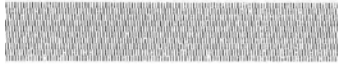
<u>Sample code</u>	<u>Result</u>
SELFTEST	<pre> ----- SYSTEM INFORMATION ----- MODEL: TDP247 FIRMWARE: 7.00 EZ CHECKSUM: 07CBD355 S/N: D452350388 TCF: NO DATE: 1970/01/01 TIME: 00:04:18 NON-RESET: 110 m (TPH) RESET: 110 m (TPH) NON-RESET: 0 (CUT) RESET: 0 (CUT) ----- PRINTING SETTING ----- SPEED: 5 IPS DENSITY: 8.0 WIDTH: 4.00 INCH HEIGHT: 4.00 INCH GAP: 0.00 INCH INTENSION: 5 CODEPAGE: 850 COUNTRY: 001 ----- Z SETTING ----- DARKNESS: 16.0 SPEED: 4 IPS WIDTH: 4.00 INCH TILDE: 7EH (^) CARET: 5EH (^) DELIMITER: 2CH (,) POWER UP: NO MOTION HEAD CLOSE: NO MOTION ----- RS232 SETTING ----- BAUD: 9600 PARITY: NONE DATA BIT: 8 STOP BIT: 1 ----- DRAM FILE (0 FILES) ----- PHYSICAL 8192 KBYTES AVAILABLE 256 KBYTES ----- FLASH FILE (0 FILES) ----- PHYSICAL 4096 KBYTES AVAILABLE 2560 KBYTES ----- </pre> 

SELFTEST PATTERN	
SELFTEST ETHERNET	<pre> ----- ETHERNET SETTING ----- NAME: PS-FF02FD MAC ADDR: 001B82-FF02FD DHCP: ON IP ADDR: 10.0.10.115 SUBNET: 255.255.255.0 GATEWAY: 10.0.10.252 PORT: 9100 ----- </pre>
SELFTEST WLAN	<pre> ----- WLAN SETTING ----- MAC ADDR: 001DC9-908397 MODE: AD-HOC SSID: TEST-AP IP ADDR: 192.168.1.3 SUBNET: 255.255.255.0 GATEWAY: 192.168.1.1 PORT: 9100 ----- </pre>
SELFTEST RS232	<pre> ----- RS232 SETTING ----- BAUD: 9600 PARITY: NONE DATA BIT: 8 STOP BIT: 1 ----- </pre>
SELFTEST SYSTEM	<pre> ----- SYSTEM INFORMATION ----- MODEL: TDP247 FIRMWARE: 7.00 EZ CHECKSUM: 07CBD355 S/N: D452350388 TCF: NO DATE: 2013/01/11 TIME: 14:57:55 NON-RESET: 145 m (TPH) RESET: 145 m (TPH) NON-RESET: 0 (CUT) RESET: 0 (CUT) ----- </pre>
SELFTEST PRINTER	<pre> ----- PRINTING SETTING ----- SPEED: 5 IPS DENSITY: 8.0 WIDTH: 4.00 INCH HEIGHT: 1.00 INCH GAP: 0.00 INCH INTENSION: 5 CODEPAGE: 850 COUNTRY: 001 ----- </pre>
SELFTEST Z	<pre> ----- Z SETTING ----- DARKNESS: 16.0 SPEED: 4 IPS WIDTH: 4.00 INCH TILDE: 7EH (~) CARET: 5EH (^) DELIMITER: 2CH (,) POWER UP: NO MOTION HEAD CLOSE: NO MOTION ----- </pre>

● EOJ

Description

Let the printer wait until process of commands (before EOJ) be finished then go on the next command.

Syntax

EOJ

Note:

This command has been supported since V6.39 EZ and later firmware.

Example

Sample Code

```
SIZE 4,0.2
GAP 0,0
DIRECTION 1
CLS
TEXT 10,10,"3",0,1,1,"Two labels are printed without stop."
PRINT 1
PRINT 1

SIZE 4,0.2
GAP 0,0
CLS
TEXT 10,10,"3",0,1,1,"Printer stops before next printing."
PRINT 1
EOJ
PRINT 1
```

Result

Paper feed direction

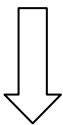

```
Printer stops before next printing.
Printer stops before next printing.
Two labels are printed without stop.
Two labels are printed without stop. } without stop
```

● DELAY

Description

Let the printer wait specific period of time then go on next command.

Syntax

DELAY ms

<u>Parameter</u>	<u>Description</u>
ms	The specific period of time. Unit is millisecond. 1000 ms = 1 second.

Note:
This command has been supported since V6.34 EZ and later firmware.

Example

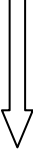
<u>Sample Code</u>
<pre>SIZE 4,0.7 GAP 0,0 DIRECTION 1 CLS TEXT 10,10,"3",0,1,1,"The delay time between two labels is 3 seconds." TEXT 10,60,"3",0,1,1,"Now second:" +@SECOND PRINT 1 DELAY 3000 PRINT 1</pre>
<u>Result</u>
 <pre>The delay time between two labels is 3 seconds. Now second:9 The delay time between two labels is 3 seconds. Now second:6</pre>

● DISPLAY

Description

This command can show the image, which is in printer's image buffer, on LCD panel.

Syntax

DISPLAY IMAGE/OFF/CLS/forecolor,backcolor/x,y,width,height/x,y, "bmpfile"/x,y, "font", "content"

<u>Parameter</u>	<u>Description</u>
IMAGE	Show the image in printer's image buffer on LCD panel. (since V6.39 EZ)
OFF	Disable this function. (since V6.39 EZ)
CLS	Show the background color and clear the items in printer's image buffer on LCD panel (since A1.90 EZ)
forecolor,backcolor	Set the color (decimal) for item and background in printer's image buffer on LCD panel (since A1.90 EZ)
x,y,width,height	Draw the bar in printer's image buffer on LCD panel (since A1.90 EZ)
x,y,"bmpfile"	Show the .bmp in printer's image buffer on LCD panel (since A1.90 EZ)
x,y,"font","content"	Show the text in printer's image buffer on LCD panel (since A1.90 EZ)

forecolor	RGB color code for text or bar (decimal)
backcolor	RGB color code for background (decimal)
x	Horizontal multiplication
y	Vertical multiplication
width	frame width
height	frame height
bmpfile	.bmp file name
font	Font name
content	Content of text string

Note:
This command only can be performed on the printer with LCD display.

Example

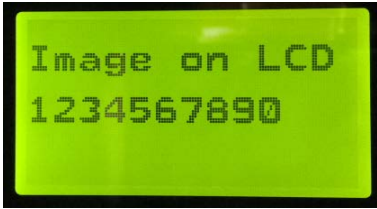
<u>Sample code</u>	<u>Result</u>
<pre>CLS TEXT 1,10, "1",0,1,1, "Image on LCD" TEXT 1,30, "1",0,1,1, "1234567890" DISPLAY IMAGE DELAY 5000 DISPLAY OFF</pre>	

CLS
DISPLAY 15128749,16711680
DISPLAY CLS
DISPLAY 10,30, "1","1234567890"
DELAY 5000
DISPLAY OFF



● INITIALPRINTER

Description

This command can restore printer settings to defaults.

Syntax

INITIALPRINTER

<u>Parameter</u>	<u>Description</u>
None	N/A

Example

Sample code

```
INITIALPRINTER
```

● MENU

Description

This command can design user's own menu with a database resident on the printer.

Syntax

MENU title\$, list\$, selected

<u>Parameter</u>	<u>Description</u>
title\$	The title string is shown on LCD screen.
list\$	List of items, separated by CRLF.
selected	It must be a variable to get the result of selection. When selected is 0, the operator has hit ESC (USB keyboard) or MENU button.

Note:
*-This command only can be performed on the printer with LCD display.
-This command has been supported since VA1.97 and later firmware.*

Example

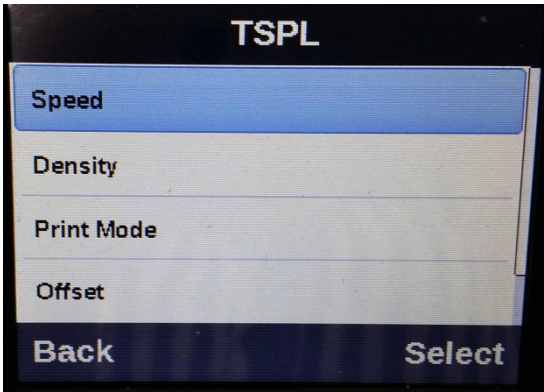
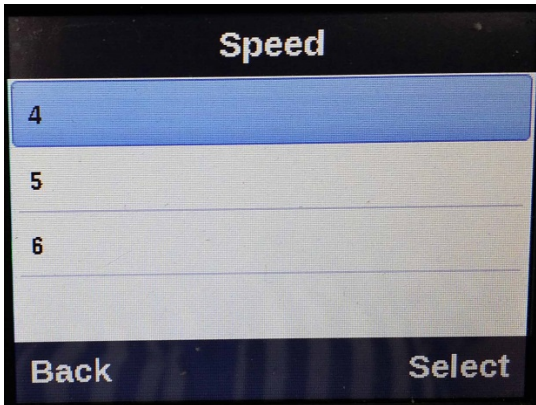
<u>Sample code</u>	<u>Result</u>
<pre>DOWNLOAD F,"TSPL" Speed Density Print Mode Offset Country EOP DOWNLOAD F,"Speed" 4 5 6 EOP DOWNLOAD F,"Density" 6 7 8 9 10 11 12 EOP DOWNLOAD F,"Print Mode" NONE TEAR OFF PEEL OFF CUT OFF EOP DOWNLOAD F,"Country" 007 031 033 034 045</pre>	 

```

EOP

DOWNLOAD F,"DEMO.BAS"

DPI = VAL(GETSETTING$("SYSTEM","INFORMATION","DPI"))

:MAINLOOP
OPEN "TSPL",0
LIST$ = FREAD$(0, LOF("TSPL"))
CLOSE 0
MENU "TSPL", LIST$, OPTION$

IF LEN(OPTION$) = 0 THEN END

IF OPTION$ = "Speed" THEN SETTING$ =
GETSETTING$("CONFIG","TSPL","SPEED")
IF OPTION$ = "Density" THEN SETTING$ =
GETSETTING$("CONFIG","TSPL","DENSITY")
IF OPTION$ = "Print Mode" THEN SETTING$ =
GETSETTING$("CONFIG","TSPL","PRINT MODE")
IF OPTION$ = "Offset" THEN SETTING$ =
GETSETTING$("CONFIG","TSPL","OFFSET")
IF OPTION$ = "Country" THEN SETTING$ =
GETSETTING$("CONFIG","TSPL","COUNTRY CODE")

IF LOF(OPTION$) <> 0 THEN
OPEN OPTION$,0
LIST$ = FREAD$(0, LOF(OPTION$))
CLOSE 0
MENU OPTION$, LIST$, SETTING$
ELSE
IF OPTION$ = "Offset" THEN INPUT "Offset", SETTING$
ENDIF

IF LEN(SETTING$) <> 0 THEN
IF OPTION$ = "Speed" THEN SPEED VAL(SETTING$)
IF OPTION$ = "Density" THEN DENSITY VAL(SETTING$)
IF OPTION$ = "Print Mode" THEN GOSUB SET_PRINT_MODE
IF OPTION$ = "Offset" THEN OFFSET VAL(SETTING$) / DPI
IF OPTION$ = "Country" THEN GOSUB SET_COUNTRY
ENDIF

GOTO MAINLOOP

:SET_PRINT_MODE
IF SETTING$ = "NONE" THEN SET TEAR OFF
IF SETTING$ = "TEAR OFF" THEN SET TEAR ON
IF SETTING$ = "PEEL OFF" THEN SET PEEL ON
IF SETTING$ = "CUT OFF" THEN SET CUTTER ON
RETURN

:SET_COUNTRY
IF SETTING$ = "007" THEN COUNTRY 007
IF SETTING$ = "031" THEN COUNTRY 031
IF SETTING$ = "033" THEN COUNTRY 033
IF SETTING$ = "034" THEN COUNTRY 034
IF SETTING$ = "045" THEN COUNTRY 045
RETURN

EOP

RUN "DEMO.BAS"

```

Label Formatting Commands

● BAR

Description

This command draws a bar on the label format.

Syntax

BAR x,y,width,height

<u>Parameter</u>	<u>Description</u>
x	The upper left corner x-coordinate (in dots)
y	The upper left corner y-coordinate (in dots)
width	Bar width (in dots)
height	Bar height (in dots)

Note:

- **200 DPI : 1 mm = 8 dots**
300 DPI : 1 mm = 12 dots
- **Recommended max. bar height is 12 mm at 4" width. Bar height over 12 mm may damage the power supply and affect the print quality.**
- **Max. print ratio is different for each printer model. Desktop and industrial printer print ratio is limited to 20% and 30% respectively.**

Example

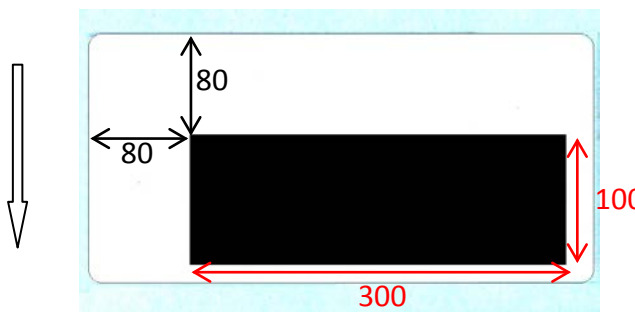
<u>Sample code</u>	<u>Result</u>
<pre>SIZE 50 mm,25 mm GAP 3 mm,0 DIRECTION 1 CLS BAR 80,80,300,100 PRINT 1,1</pre>	

See Also

BOX

● BARCODE

Description

This command prints 1D barcodes. The available barcodes are listed below:

Code Type	Description	Narrow : Width					Max. data length
		1:1	1:2	1:3	2:5	3:7	
128	Code 128, switching code subset automatically.	V					
128M	Code 128, switching code subset manually.	V					
EAN128	EAN128, switching code subset automatically.	V					
EAN128M	EAN128M, switching code subset automatically.	V					
25	Interleaved 2 of 5.		V	V	V		Length is even
25C	Interleaved 2 of 5 with check digit.		V	V	V		Length is odd
25S	Standard 2 of 5.		V	V	V		
25I	Industrial 2 of 5.		V	V	V		
39	Code 39, switching standard and full ASCII mode automatically.		V	V	V		
39C	Code 39 with check digit.		V	V	V		
93	Code 93.			V			
EAN13	EAN 13.	V					12
EAN13+2	EAN 13 with 2 digits add-on.	V					14
EAN13+5	EAN 13 with 5 digits add-on.	V					17
EAN8	EAN 8.	V					7
EAN8+2	EAN 8 with 2 digits add-on.	V					9
EAN8+5	EAN 8 with 5 digits add-on.	V					12
CODA	Codabar.		V	V	V		
POST	Postnet.	V					5, 9, 11
UPCA	UPC-A.	V					11
UPCA+2	UPC-A with 2 digits add-on.	V					13
UPA+5	UPC-A with 5 digits add-on.	V					16
UPCE	UPC-E.	V					6
UPCE+2	UPC-E with 2 digits add-on.	V					8
UPE+5	UPC-E with 5 digits add-on.	V					11
MSI	MSI.		V	V	V		
MSIC	MSI with check digit.		V	V	V		
PLESSEY	PLESSEY.		V	V	V		
CPOST	China post.					V	
ITF14	ITF14.		V	V	V		13
EAN14	EAN14.	V					13
11	Code 11.		V	V	V		
TELEPEN	Telepen. <i>*Since V6.89EZ.</i>		V	V	V		
TELEPENN	Telepen number. <i>*Since V6.89EZ.</i>		V	V	V		
PLANET	Planet. <i>*Since V6.89EZ.</i>	V					
CODE49	Code 49. <i>*Since V6.89EZ.</i>	V					
DPI	Deutsche Post Identcode. <i>*Since V6.91EZ.</i>		V	V	V		11
DPL	Deutsche Post Leitcode. <i>*Since V6.91EZ.</i>		V	V	V		13
LOGMARS	A special use of Code 39. <i>*Since V6.88EZ.</i>		V	V	V		

Syntax

BARCODE X,Y, "code type",height,human readable,rotation,narrow,wide,[alignment,] "content "

<u>Parameter</u>	<u>Description</u>																																												
X	Specify the x-coordinate bar code on the label																																												
Y	Specify the y-coordinate bar code on the label																																												
code type																																													
128	Code 128, switching code subset A, B, C automatically																																												
128M	Code 128, switching code subset A, B, C manually <table border="1" data-bbox="472 445 1109 792"> <thead> <tr> <th>Control code</th> <th>A</th> <th>B</th> <th>C</th> </tr> </thead> <tbody> <tr> <td>096</td> <td>FNC3</td> <td>FNC3</td> <td>NONE</td> </tr> <tr> <td>097</td> <td>FNC2</td> <td>FNC2</td> <td>NONE</td> </tr> <tr> <td>098</td> <td>SHIFT</td> <td>SHIFT</td> <td>NONE</td> </tr> <tr> <td>099</td> <td>CODE C</td> <td>CODE C</td> <td>NONE</td> </tr> <tr> <td>100</td> <td>CODE B</td> <td>FNC4</td> <td>CODE B</td> </tr> <tr> <td>101</td> <td>FNC4</td> <td>CODE A</td> <td>CODE A</td> </tr> <tr> <td>102</td> <td>FNC1</td> <td>FNC1</td> <td>FNC1</td> </tr> <tr> <td>103</td> <td colspan="3">Start (CODE A)</td> </tr> <tr> <td>104</td> <td colspan="3">Start (CODE B)</td> </tr> <tr> <td>105</td> <td colspan="3">Start (CODE C)</td> </tr> </tbody> </table> <p><i>Use "!" as a starting character for the control code followed by three control codes. If the start subset is not set, the default starting subset is B.</i></p>	Control code	A	B	C	096	FNC3	FNC3	NONE	097	FNC2	FNC2	NONE	098	SHIFT	SHIFT	NONE	099	CODE C	CODE C	NONE	100	CODE B	FNC4	CODE B	101	FNC4	CODE A	CODE A	102	FNC1	FNC1	FNC1	103	Start (CODE A)			104	Start (CODE B)			105	Start (CODE C)		
Control code	A	B	C																																										
096	FNC3	FNC3	NONE																																										
097	FNC2	FNC2	NONE																																										
098	SHIFT	SHIFT	NONE																																										
099	CODE C	CODE C	NONE																																										
100	CODE B	FNC4	CODE B																																										
101	FNC4	CODE A	CODE A																																										
102	FNC1	FNC1	FNC1																																										
103	Start (CODE A)																																												
104	Start (CODE B)																																												
105	Start (CODE C)																																												
EAN128	Code 128, switching code subset A, B, C automatically																																												
EAN128M	Code 128, switching code subset A, B, C manually																																												
25	Interleaved 2 of 5																																												
25C	Interleaved 2 of 5 with check digits																																												
25S	Standard 2 of 5																																												
25I	Industrial 2 of 5																																												
39	Code 39 full ASCII for TSPL2 printers Code 39 standard for TSPL printers Auto switch full ASCII and standard code 39 for PLUS models <i>Note: Please refer to printer model list for detail.</i>																																												
39C	Code 39 full ASCII with check digit for TSPL2 printers Code 39 standard with check digit for TSPL printers Auto switch full ASCII and standard code 39 for PLUS models <i>Note: Please refer to printer model list for detail.</i>																																												
39S	Code 39 standard for TSPL2 printers <i>Note: Please refer to printer model list for detail.</i>																																												
93	Code 93																																												
EAN13	EAN 13																																												
EAN13+2	EAN 13 with 2 digits add-on																																												
EAN13+5	EAN 13 with 5 digits add-on																																												
EAN8	EAN 8																																												
EAN8+2	EAN 8 with 2 digits add-on																																												
EAN8+5	EAN 8 with 5 digits add-on																																												
CODA	Codabar																																												
POST	Postnet																																												
UPCA	UPC-A																																												
UPCA+2	UPC-A with 2 digits add-on																																												
UPCA+5	UPC-A with 5 digits add-on																																												
UPCE	UPC-E																																												
UPCE+2	UPC-E with 2 digits add-on																																												
UPCE+5	UPC-E with 5 digits add-on																																												
CPOST	China post code																																												
MSI	MSI code																																												

MSIC	MSI with check digit
PLESSEY	PLESSEY code
ITF14	ITF 14 code
EAN14	EAN 14 code
11	Code 11
TELEPEN	Telepen code
TELEPENN	Telepen code. Number only
PLANET	Planet code
CODE49	Code 49
DPI	Deutsche Post Identcode
DPL	Deutsche Post Leitcode

Note:

* TDP-643 Plus , TTP-243, TTP-342, TTP-244ME and TTP-342M models are not supported MSI, MSIC, PLESSY, ITF14, EAN14 and 11.

* TTP-248M model are not supported MSIC and 11.

Height
human readable Bar code height (in dots)
0: not readable
1: human readable aligns to left
2: human readable aligns to center
3: human readable aligns to right

rotation
0 : No rotation
90 : Rotate 90 degrees clockwise
180 : Rotate 180 degrees clockwise
270 : Rotate 270 degrees clockwise

narrow
wide Width of narrow element (in dots)
 Width of wide element (in dots)

	narrow : wide 1:1	narrow : wide 1:2	narrow : wide 1:3	narrow : wide 2:5	narrow : wide 3:7
128	10x	-	-	-	-
EAN128	10x	-	-	-	-
EAN128M	10x				
25	-	10x	10x	5x	-
25C	-	10x	10x	5x	-
25S		10x	10x	5x	
25I		10x	10x	5x	
39	-	10x	10x	5x	-
39C	-	10x	10x	5x	-
93	-	-	10x	-	-
EAN13	8x	-	-	-	-
EAN13+2	8x	-	-	-	-
EAN13+5	8x	-	-	-	-
EAN 8	8x	-	-	-	-
EAN 8+2	8x	-	-	-	-
EAN 8+5	8x	-	-	-	-
CODA	-	10x	10x	5x	-
POST	1x	-	-	-	-
UPCA	8x	-	-	-	-
UPCA+2	8x	-	-	-	-
UPCA+5	8x	-	-	-	-
UPCE	8x	-	-	-	-
UPCE+2	8x	-	-	-	-
UPCE+5	8x	-	-	-	-
CPOST	-	-	-	-	1x
MSI	-	-	10x	-	-
MSIC			10x		
PLESSY	-	-	10x	-	-
ITF14	-	10x	10x	5x	-

EAN14	8x	-	-	-	-
11	-	10x	10x	5x	-

alignment Specify the alignment of barcode

- 0 : default (Left)
- 1 : Left
- 2 : Center
- 3 : Right

content Content of barcode

Please note that the maximum number of digits of bar code content.

Code Type	Character sets	Max. data length
128	See Character set for CODE128.	-
128M	See Character set for CODE128.	-
EAN128	See Character set for CODE128.	-
EAN128M	See Character set for CODE128.	-
25	0123456789	Length is even.
25C	0123456789	Length is odd.
25S	0123456789	
25I	0123456789	
39 I	0123456789[Space]ABCDEFGHIJKLMNPOQRSTUVWXYZ -./+%	-
39 I Full ASCII	0123456789[Space]ABCDEFGHIJKLMNPOQRSTUVWXYZ !#\$%&'()*+,-./:;@[\]^_`abcdefghijklmnopqrstuvwxyz z{ }~	-
93	0123456789[Space]ABCDEFGHIJKLMNPOQRSTUVWXYZ !#\$%&'()*+,-./:;@[\]^_`abcdefghijklmnopqrstuvwxyz z{ }~	-
EAN13	0123456789	12
EAN13+2	0123456789	14
EAN13+5	0123456789	17
EAN8	0123456789	7
EAN8+2	0123456789	9
EAN8+5	0123456789	12
CODA	0123456789-\$/+.	-
POST	0123456789	5, 9, 11
UPCA	0123456789	11
UPCA+2	0123456789	13
UPA+5	0123456789	16
UPCE	0123456789	6
UPCE+2	0123456789	8
UPE+5	0123456789	11
MSI	0123456789	-
MSIC	0123456789	-
PLESSEY	0123456789	-
CPOST	0123456789	-
ITF14	0123456789	13
EAN14	0123456789	13
11	0123456789-	-
TELEPEN	ASCII 0 to 127	30
TELEPENN	0123456789	60
PLANET	0123456789	38
CODE49	ASCII 0 to 127	81
DPI	0123456789	11
DPL	0123456789	13
LOGMARS	0123456789[Space]ABCDEFGHIJKLMNPOQRSTUVWXYZ -./+%	-



Note:

Since V5.10EZ, \[R] means carriage return character 0x0D and \[L] means line feed character 0x0A.

Character set for CODE 128

Value	128A	128B	128C	Value	128A	128B	128C	Value	128A	128B	128C
0	space	space	00	36	D	D	36	72	BS	h	72
1	!	!	01	37	E	E	37	73	HT	i	73
2	"	"	02	38	F	F	38	74	LF	j	74
3	#	#	03	39	G	G	39	75	VT	k	75
4	\$	\$	04	40	H	H	40	76	FF	l	76
5	%	%	05	41	I	I	41	77	CR	m	77
6	&	&	06	42	J	J	42	78	SO	n	78
7	'	'	07	43	K	K	43	79	SI	o	79
8	((08	44	L	L	44	80	DLE	p	80
9))	09	45	M	M	45	81	DC1	q	81
10	*	*	10	46	N	N	46	82	DC2	r	82
11	+	+	11	47	O	O	47	83	DC3	s	83
12	,	,	12	48	P	P	48	84	DC4	t	84
13	-	-	13	49	Q	Q	49	85	NAK	u	85
14	.	.	14	50	R	R	50	86	SYN	v	86
15	/	/	15	51	S	S	51	87	ETB	w	87
16	0	0	16	52	T	T	52	88	CAN	x	88
17	1	1	17	53	U	U	53	89	EM	y	89
18	2	2	18	54	V	V	54	90	SUB	z	90
19	3	3	19	55	W	W	55	91	ESC	{	91
20	4	4	20	56	X	X	56	92	FS		92
21	5	5	21	57	Y	Y	57	93	GS	}	93
22	6	6	22	58	Z	Z	58	94	RS	~	94
23	7	7	23	59	[[59	95	US	DEL	95
24	8	8	24	60	\	\	60	96	FNC 3	FNC 3	96
25	9	9	25	61]]	61	97	FNC 2	FNC 2	97
26	:	:	26	62	^	^	62	98	Shift B	Shift A	98
27	;	;	27	63	_	_	63	99	Code C	Code C	99
28	<	<	28	64	NUL	`	64	100	Code B	FNC4	Code B
29	=	=	29	65	SOH	a	65	101	FNC 4	Code A	Code A
30	>	>	30	66	STX	b	66	102	FNC 1	FNC 1	FNC 1
31	?	?	31	67	ETX	c	67	103	Start Code A		
32	@	@	32	68	EOT	d	68	104	Start Code B		
33	A	A	33	69	ENQ	e	69	105	Start Code C		
34	B	B	34	70	ACK	f	70				
35	C	C	35	71	BEL	g	71				

Example

Sample Code	Result
<pre> SIZE 4,1 GAP 0,0 DIRECTION 1 CLS TEXT 10,10, "2",0,1,1, "Human readable alignment" BARCODE 10,50, "128",100,1,0,2,2, "left" BARCODE 310,50, "128",100,2,0,2,2, "center" BARCODE 610,50, "128",100,3,0,2,2, "right" PRINT 1 </pre>	<p>Human readable alignment</p>  <p>left center right</p>
<pre> SIZE 4,1 GAP 0,0 DIRECTION 1 CLS TEXT 10,10, "2",0,1,1, "Code 128, switch code subset automatically. " BARCODE 10,50, "128",100,1,0,2,2, "123456abcd123456" PRINT 1 </pre>	<p>Code 128, switch code subset automatically.</p>  <p>123456abcd123456</p>

<p>SIZE 4,1 GAP 0,0 DIRECTION 1 CLS TEXT 10,10, "2",0,1,1, "Code 128, switch code subset manually." BARCODE 10,50, "128M",100,1,0,2,2, "!104!096ABCD!101EFGH" PRINT 1</p> <p>Note: <i>The above example of code 128M encoded with CODE B start character. The next character will be the code 128 function character FNC3 which is then followed by the ABCD characters and EFGH characters encoded as CODE A subset.</i></p>	<p>Code 128, switch code subset manually.</p>  <p>ABCDEFGH</p>
<p>SIZE 4,1 GAP 0,0 DIRECTION 1 CLS TEXT 10,10, "2",0,1,1, "TELEPEN" BARCODE 10,50, "TELEPEN",100,1,0,2,6, "abcd1234ABCD" PRINT 1</p>	<p>TELEPEN</p>  <p>abcd1234ABCD</p>
<p>SIZE 4,4 GAP 0,0 DIRECTION 1 CLS TEXT 400,26, "2",0,1,1,2, "TELEPEN Number" BARCODE 400,50, "TELEPENN",60,2,0,2,6,2, "1234567890" TEXT 400,136, "2",0,1,1,2, "Code 11" BARCODE 400,160, "11",60,2,0,2,6,2, "1234567890" TEXT 400,246, "2",0,1,1,2, "PLANET" BARCODE 400,270, "PLANET",60,2,0,2,2,2, "12345678901" TEXT 400,356, "2",0,1,1,2, "Deutsche Post Identcode." BARCODE 400,380, "DPI",60,2,0,2,6,2, "12345678901" TEXT 400,466, "2",0,1,1,2, "Deutsche Post Leitcode. " BARCODE 400,490, "DPL",60,2,0,2,6,2, "123456789012" TEXT 400,576, "2",0,1,1,2, "Code 49" BARCODE 400,600, "CODE49",60,2,0,2,2,2, "1234567890" PRINT 1</p>	 <p>TELEPEN Number</p>  <p>1234567890 Code 11</p>  <p>1234567890 PLANET</p>  <p>12345678901 Deutsche Post Identcode.</p>  <p>123456789016 Deutsche Post Leitcode.</p>  <p>01234567890128 Code 49</p>  <p>1234567890</p>

● TLC39

Description

This command draws TLC39, TCIF Linked Bar Code 3 of 9, barcode.

Syntax

TLC39 x,y,rotation,[height],[narrow],[wide],[cellwidth],[cellheight,] "ECI number,Serial number & additional data"

<u>Parameter</u>	<u>Description</u>
x	Specify the x-coordinate
y	Specify the y-coordinate
rotation	0 : No rotation 90 : Rotate 90 degrees clockwise 180 : Rotate 180 degrees clockwise 270 : Rotate 270 degrees clockwise
height	Height of Code39 in dots (Default is 40)
narrow	Width of narrow element of Code39 in dots (Default is 2)
wide	Width of wide element of Code39 in dots (Default is 4)
cellwidth	Width of cell of MicroPDF417 in dots (Default is 2)
cellheight	Height of cell of MicroPDF417 in dots (Default is 4)
ECI number	Must be 6 digits which is used to generate Code39
Serial number & additional data	Alphanumeric is for Micro-PDF417

Note:

- **Comma (",") is necessary between ECI number and Serial number & additional data.**
- **This command has been supported since V6.89 EZ and later firmware.**

Example

<u>Sample Code</u>
<pre>SIZE 4,1.2 GAP 0,0 DIRECTION 1 CLS TEXT 10,10, "3",0,1,1, "TLC39 code" TLC39 10,50,0, "123456,SN00000001,00601,01501" TLC39 310,50,0,80,3,6,3,4, "123456,SN00000001,00601,01501" PRINT 1</pre>
<u>Result</u>
<p style="text-align: center;">TLC39 code</p> 

● BITMAP

Description

This command draws bitmap images (as opposed to BMP graphic files).

Syntax

BITMAP X,Y,width,height,mode,bitmap data...

<u>Parameter</u>	<u>Description</u>
X	Specify the x-coordinate
Y	Specify the y-coordinate
width	Image width (in bytes)
height	Image height (in dots)
mode	Graphic modes listed below: 0: OVERWRITE 1: OR 2: XOR
bitmap data	Bitmap data

Example

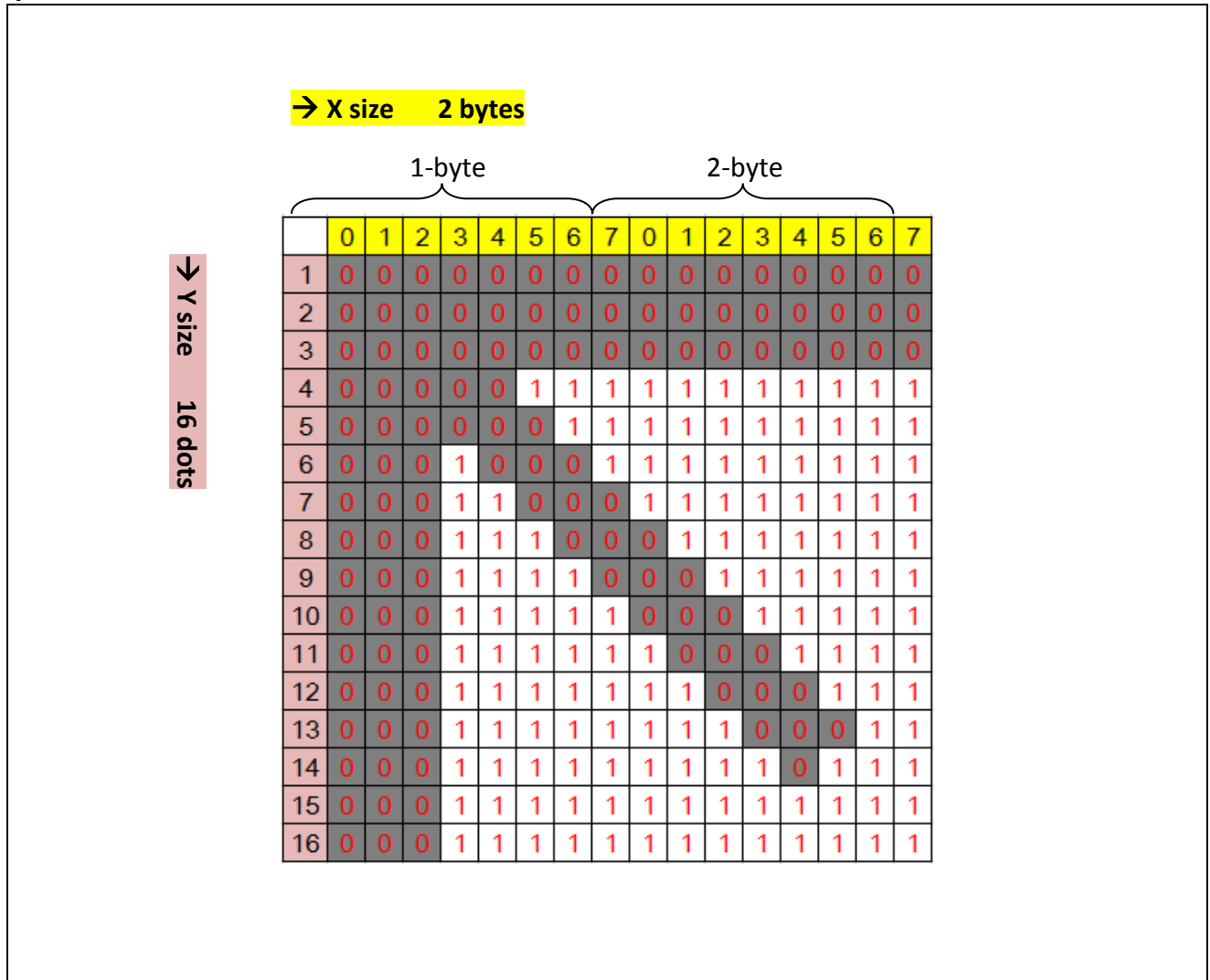

Y- axis	X – axis			
	1-byte		2-byte	
	Binary	Hexadecimal	Binary	Hexadecimal
1	00000000	00	00000000	00
2	00000000	00	00000000	00
3	00000000	00	00000000	00
4	00000111	07	11111111	FF
5	00000011	03	11111111	FF
6	00010001	11	11111111	FF
7	00011000	18	11111111	FF
8	00011100	1C	01111111	7F
9	00011110	1E	00111111	3F
10	00011111	1F	00011111	1F
11	00011111	1F	10001111	8F
12	00011111	1F	11000111	C7
13	00011111	1F	11100011	E3
14	00011111	1F	11110111	F7
15	00011111	1F	11111111	FF
16	00011111	1F	11111111	FF

Sample Code (ASCII)	Hexadecimal	Result
SIZE 4,2	53 49 5A 45 20 34 2C 32 0D	↖
GAP 0,0	0A 47 41 50 20 30 2C 30 0D	
CLS	0A 43 4C 53 0D 0A 42 49 54	
BITMAP 200,200,2,16,0,	4D 41 50 20 32 30 30 2C 32 30	
▣ _____ ▣ ▣ ▣ ▣-?-	30 2C 32 2C 31 36 2C 30 2C 00	
???? ▣	00 00 00 00 00 07 FF 03 FF 11	
PRINT 1,1	FF 18 FF 1C 7F 1E 3F 1F 1F 1F	
	8F 1F C7 1F E3 1F E7 1F FF 1F	
	FF 0D 0A 50 52 49 4E 54 20 31	
	2C 31 0D 0A	

See Also

PUTBMP, PUTPCX

● BOX

Description

This command draws rectangles on the label.

Syntax

BOX x,y,x_end,y_end,line thickness[,radius]

<u>Parameter</u>	<u>Description</u>
x	Specify x-coordinate of upper left corner (in dots)
y	Specify y-coordinate of upper left corner (in dots)
x_end	Specify x-coordinate of lower right corner (in dots)
y_end	Specify y-coordinate of lower right corner (in dots)
line thickness	Line thickness (in dots)
radius	Optional. Specify the round corner. Default is 0. <i>*Since V5.28 EZ</i>

Note:

- **200 DPI : 1 mm = 8 dots**
300 DPI : 1 mm = 12 dots
- **Recommended max. thickness of box is 12 mm at 4" width. Thickness of box larger than 12 mm may damage the power supply and affect the print quality. Max. print ratio is different for each printer model. Desktop and industrial printer print ratio is limited to 20% and 30% respectively.**

Example

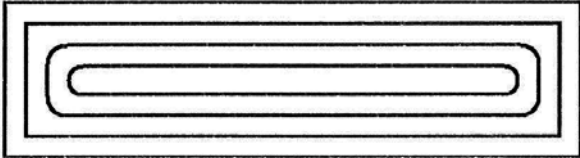
<u>Sample code</u>	<u>Result</u>
<pre>SIZE 4,1.1 CLS BOX 60,60,610,210,4 BOX 80,80,590,190,4 BOX 100,100,570,170,4,20 BOX 120,120,550,150,4,20 PRINT 1</pre>	

See Also

BAR

● CIRCLE

Description

This command draws a circle on the label.

Syntax

CIRCLE X_start,Y_start,diameter,thickness

<u>Parameter</u>	<u>Description</u>
X_start	Specify x-coordinate of upper left corner (in dots)
Y_start	Specify y-coordinate of upper left corner (in dots)
diameter	Specify the diameter of the circle (in dots)
thickness	Thickness of the circle (in dots)

Example

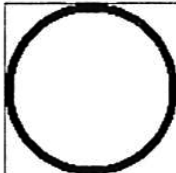
<u>Sample code</u>	<u>Result</u>
<pre>SIZE 80 mm,30 mm GAP 0,0 DIRECTION 1 CLS BAR 250,20,100,1 BAR 250,20,1,100 CIRCLE 250,20,100,5 PRINT 1</pre>	

● ELLIPSE

Description

This command draws an ellipse on the label.

Syntax

ELLIPSE x,y,width,height,thickness

<u>Parameter</u>	<u>Description</u>
x	Specify x-coordinate of upper left corner (in dots)
y	Specify y-coordinate of upper left corner (in dots)
width	Specify the width of the ellipse (in dots)
height	Specify the height of the ellipse (in dots)
thickness	Thickness of the ellipse (in dots)

Note:
This command has been supported since V6.91 EZ and later firmware.

Example

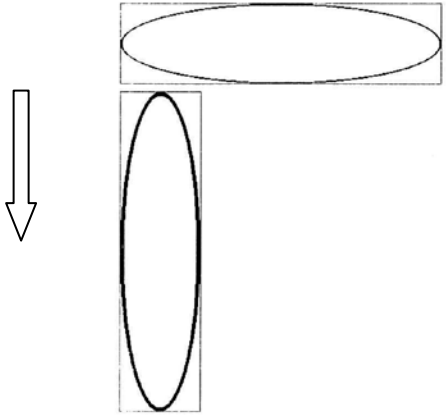
<u>Sample code</u>	<u>Result</u>
<pre>SIZE 4,3 GAP 0,0 DIRECTION 1 CLS BOX 10,10,410,110,1 ELLIPSE 10,10,400,100,2 BOX 10,120,110,520,1 ELLIPSE 10,120,100,400,5 PRINT 1</pre>	

● CODABLOCK F mode

Description

This command draws CODABLOCK F mode barcode.

Syntax

CODABLOCK x,y,rotation,[row height,]module width,] "content"

<u>Parameter</u>	<u>Description</u>
x	Specify the x-coordinate
y	Specify the y-coordinate
rotation	0 : No rotation 90 : Rotate 90 degrees clockwise 180 : Rotate 180 degrees clockwise 270 : Rotate 270 degrees clockwise
row height	The height of individual row equals to row height x module width (Default is 8)
module width	Width of narrow element of CODABLOCK in dots (Default is 2)
content	content of CODABLOCK bar code

Note:
This command has been supported since V6.89 EZ and later firmware.

Example

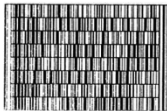
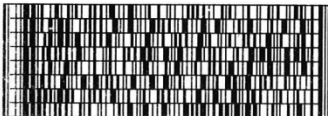
Sample Code	
<pre> SIZE 4,1.5 GAP 0,0 DIRECTION 1 CLS TEXT 10,10, "3",0,1,1, "Codablock F" CODABLOCK 10,50,0, "We stand behind our products with one of the most comprehensive support programs in the Auto-ID industry." PRINT 1 CLS TEXT 10,10, "3",0,1,1, "Codablock F" CODABLOCK 10,50,0,16,1, "We stand behind our products with one of the most comprehensive support programs in the Auto-ID industry." PRINT 1 </pre>	
Result	
	<p>Codablock F</p>  <p>Codablock F</p> 

● DMATRIX

Description



This command defines a DataMatrix 2D bar code. Currently, only ECC200 error correction is supported.

Syntax

DMATRIX x,y,width,height,[c#,x#,r#,a#,row,col,] "content"

Parameter	Description																																																																																																												
x	Horizontal start position (in dots)																																																																																																												
y	Vertical start position (in dots)																																																																																																												
width	The expected width of barcode area (in dots)																																																																																																												
height	The expected height of barcode area (in dots)																																																																																																												
c#	Escape sequence control character (decimal digit) Ex. C126 means ~ (1) ~X is shift character for control characters.																																																																																																												
	<table border="1"> <thead> <tr> <th>~X</th> <th>Hex</th> <th>ASCII</th> <th>~X</th> <th>HEX</th> <th>ASCII</th> <th>~X</th> <th>HEX</th> <th>ASCII</th> <th>~X</th> <th>HEX</th> <th>ASCII</th> </tr> </thead> <tbody> <tr> <td>~@</td> <td>00</td> <td>NUL</td> <td>~H</td> <td>08</td> <td>BS</td> <td>~P</td> <td>10</td> <td>DLE</td> <td>~X</td> <td>18</td> <td>CAN</td> </tr> <tr> <td>~A</td> <td>01</td> <td>SOH</td> <td>~I</td> <td>09</td> <td>HT</td> <td>~Q</td> <td>11</td> <td>DC1</td> <td>~Y</td> <td>19</td> <td>EM</td> </tr> <tr> <td>~B</td> <td>02</td> <td>STX</td> <td>~J</td> <td>0A</td> <td>LF</td> <td>~R</td> <td>12</td> <td>DC2</td> <td>~Z</td> <td>1A</td> <td>SUB</td> </tr> <tr> <td>~C</td> <td>03</td> <td>ETX</td> <td>~K</td> <td>0B</td> <td>VT</td> <td>~S</td> <td>13</td> <td>DC3</td> <td>~[</td> <td>1B</td> <td>ESC</td> </tr> <tr> <td>~D</td> <td>04</td> <td>EOT</td> <td>~L</td> <td>0C</td> <td>FF</td> <td>~T</td> <td>14</td> <td>DC4</td> <td>~\</td> <td>1C</td> <td>FS</td> </tr> <tr> <td>~E</td> <td>05</td> <td>ENQ</td> <td>~M</td> <td>0D</td> <td>CR</td> <td>~U</td> <td>15</td> <td>NAK</td> <td>~]</td> <td>1D</td> <td>GS</td> </tr> <tr> <td>~F</td> <td>06</td> <td>ACK</td> <td>~N</td> <td>0E</td> <td>SO</td> <td>~V</td> <td>16</td> <td>SYN</td> <td>~^</td> <td>1E</td> <td>RS</td> </tr> <tr> <td>~G</td> <td>07</td> <td>BEL</td> <td>~O</td> <td>0F</td> <td>SI</td> <td>~W</td> <td>17</td> <td>ETB</td> <td>~_</td> <td>1F</td> <td>US</td> </tr> </tbody> </table>	~X	Hex	ASCII	~X	HEX	ASCII	~X	HEX	ASCII	~X	HEX	ASCII	~@	00	NUL	~H	08	BS	~P	10	DLE	~X	18	CAN	~A	01	SOH	~I	09	HT	~Q	11	DC1	~Y	19	EM	~B	02	STX	~J	0A	LF	~R	12	DC2	~Z	1A	SUB	~C	03	ETX	~K	0B	VT	~S	13	DC3	~[1B	ESC	~D	04	EOT	~L	0C	FF	~T	14	DC4	~\	1C	FS	~E	05	ENQ	~M	0D	CR	~U	15	NAK	~]	1D	GS	~F	06	ACK	~N	0E	SO	~V	16	SYN	~^	1E	RS	~G	07	BEL	~O	0F	SI	~W	17	ETB	~_	1F	US
~X	Hex	ASCII	~X	HEX	ASCII	~X	HEX	ASCII	~X	HEX	ASCII																																																																																																		
~@	00	NUL	~H	08	BS	~P	10	DLE	~X	18	CAN																																																																																																		
~A	01	SOH	~I	09	HT	~Q	11	DC1	~Y	19	EM																																																																																																		
~B	02	STX	~J	0A	LF	~R	12	DC2	~Z	1A	SUB																																																																																																		
~C	03	ETX	~K	0B	VT	~S	13	DC3	~[1B	ESC																																																																																																		
~D	04	EOT	~L	0C	FF	~T	14	DC4	~\	1C	FS																																																																																																		
~E	05	ENQ	~M	0D	CR	~U	15	NAK	~]	1D	GS																																																																																																		
~F	06	ACK	~N	0E	SO	~V	16	SYN	~^	1E	RS																																																																																																		
~G	07	BEL	~O	0F	SI	~W	17	ETB	~_	1F	US																																																																																																		
	(2) ~1 means FNC1.																																																																																																												
	(3) ~dNNN creates ASCII decimal value NNN for a codeword. Must be 3 digits. 000 ~ 255.																																																																																																												
	(4) ~ in data is encoded by ~~.																																																																																																												
X#	Module size (in dots)																																																																																																												
r#	Rotation 0 : No rotation 90 : Rotate 90 degrees clockwise 180 : Rotate 180 degrees clockwise 270 : Rotate 270 degrees clockwise																																																																																																												
a#	0 : Square (default) 1 : Rectangle																																																																																																												
row	Symbol size of row: 10 to 144																																																																																																												
col	Symbol size of col: 10 to 144																																																																																																												
content	Content of DataMatrix 2D bar code																																																																																																												
Note:																																																																																																													
- This command has been supported since V6.89 EZ and later firmware. The parameter "a#" has been supported since V8.01 EZ and later firmware.																																																																																																													
- For standard symbol sizes for DataMatrix 2D barcode, please refer to below list.																																																																																																													
<table border="1"> <thead> <tr> <th colspan="3">Square</th> <th>Rectangle</th> </tr> </thead> <tbody> <tr> <td>10 x 10</td> <td>26 x 26</td> <td>72 x 72</td> <td>8 x 18</td> </tr> <tr> <td>12 x 12</td> <td>32 x 32</td> <td>80 x 80</td> <td>8 x 32</td> </tr> <tr> <td>14 x 14</td> <td>36 x 36</td> <td>88 x 88</td> <td>12 x 26</td> </tr> <tr> <td>16 x 16</td> <td>40 x 40</td> <td>96 x 96</td> <td>12 x 36</td> </tr> <tr> <td>18 x 18</td> <td>44 x 44</td> <td>104 x 104</td> <td>16 x 36</td> </tr> <tr> <td>20 x 20</td> <td>48 x 48</td> <td>120 x 120</td> <td>16 x 48</td> </tr> <tr> <td>22 x 22</td> <td>52 x 52</td> <td>132 x 132</td> <td></td> </tr> <tr> <td>24 x 24</td> <td>64 x 64</td> <td>144 x 144</td> <td></td> </tr> </tbody> </table>		Square			Rectangle	10 x 10	26 x 26	72 x 72	8 x 18	12 x 12	32 x 32	80 x 80	8 x 32	14 x 14	36 x 36	88 x 88	12 x 26	16 x 16	40 x 40	96 x 96	12 x 36	18 x 18	44 x 44	104 x 104	16 x 36	20 x 20	48 x 48	120 x 120	16 x 48	22 x 22	52 x 52	132 x 132		24 x 24	64 x 64	144 x 144																																																																									
Square			Rectangle																																																																																																										
10 x 10	26 x 26	72 x 72	8 x 18																																																																																																										
12 x 12	32 x 32	80 x 80	8 x 32																																																																																																										
14 x 14	36 x 36	88 x 88	12 x 26																																																																																																										
16 x 16	40 x 40	96 x 96	12 x 36																																																																																																										
18 x 18	44 x 44	104 x 104	16 x 36																																																																																																										
20 x 20	48 x 48	120 x 120	16 x 48																																																																																																										
22 x 22	52 x 52	132 x 132																																																																																																											
24 x 24	64 x 64	144 x 144																																																																																																											

Example

Sample code	Result
<p> SIZE 4,3 GAP 0,0 DIRECTION 1 CLS DMATRIX 10,110,400,400, "DMATRIX EXAMPLE 1" DMATRIX 310,110,400,400,x6, "DMATRIX EXAMPLE 2" DMATRIX 10,310,400,400,x8,18,18, "DMATRIX EXAMPLE 3" PRINT 1,1 </p>	
<p> Sample code for FNC SIZE 4,1 GAP 0,0 CLS DIRECTION 1 DMATRIX 100,50,100,100,c126,x6,18,18, "~1241sPn~110sLot~130sQty " PRINT 1 </p>	
<p> Sample code in rectangular shape SIZE 4,1 GAP 0,0 DIRECTION 1 CLS DMATRIX 100,110,600,600,a1, "DMATRIX EXAMPLE 1" PRINT 1,1 </p>	

● ERASE

Description

This command clears a specified region in the image buffer.

Syntax

ERASE *x,y,x_width,y_height*

<u>Parameter</u>	<u>Description</u>
x	The x-coordinate of the starting point (in dots)
y	The y-coordinate of the starting point (in dots)
x_width	The region width in x-axis direction (in dots)
y_height	The region height in y-axis direction (in dots)

Example

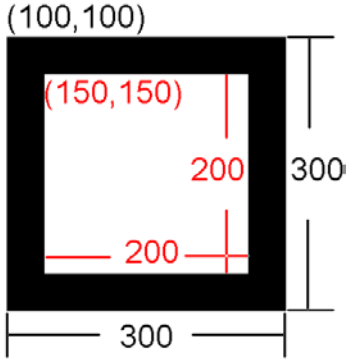
<u>Sample code</u>	<u>Result</u>
<pre>SIZE 4,2.5 GAP 0,0 DIRECTION 1 CLS BAR 100,100,300,300 ERASE 150,150,200,200 PRINT 1,1</pre>	

See Also

CLS

● MAXICODE

Description

This command defines a 2D Maxicode.

Syntax

MAXICODE x,y,mode,[class,country,post,Lm,] "content"	
MAXICODE x,y,mode,class,country,postal code, "content"	For mode 2 or 3, If country is 840, the postal code is in 99999,9999 format. For other countries, the code is up to 6 alphanumeric characters.
MAXICODE x,y,mode,[Lm,] "content"	For mode 4,5,6, AIM special format is supported, see page 23 in the spec. Mode 6 is not supported in TSPL2 printer firmware.

Parameter	Description
x	X-coordinate of the starting point (in dot)
y	Y-coordinate of the starting point (in dot)
mode	2,3,4,5
class	Class of service, 3-digit number (for mode 2,3)
country	Country code, 3-digit number (for mode 2,3)
post	Post code (for mode 2,3) Mode 2(USA): 5-digit + 4-digit number Mode 3(Canada): 6 alphanumeric post code included by double quotes.
Lm	Expression length (double quote is ignored) , $1 \leq m \leq 138$, (this parameter is just for mode 4 and 5)
content	Content of 2D Maxicode
	Note: If parameter Lm is used, double quotes (") are unnecessary.

Example

<p>Sample code</p> <pre> SIZE 4,2 GAP 0,0 DIRECTION 1 CLS REM *****Mode 2 For USA***** MAXICODE 110,100,2,300,840,06810,7317, "DEMO 2 FOR USA MAXICODE" TEXT 100,50, "3",0,1,1, "Mode 2 For USA" PRINT 1,1 </pre>

```

REM *****Mode 3 For Canada*****
CLS
MAXICODE 110,100,3,300,863, "107317", "DEMO 3 FOR CANADA MAXICODE"
TEXT 100,50, "3",0,1,1, "Mode 3 For CANADA"
PRINT 1,1

REM *****MODE4*****
CLS
MAXICODE 110,100,4, "DEMO 4 FOR MAXICODE"
MAXICODE 600,100,4,L19,DEMO 4 FOR MAXICODE
TEXT 100,50, "3",0,1,1, "Mode 4 FOR MAXICODE"
PRINT 1,1

REM *****MODE 5*****
CLS
MAXICODE 110,100,5, "DEMO 5 FOR MAXICODE"
MAXICODE 600,100,5,L19,DEMO 5 FOR MAXICODE
TEXT 100,50, "3",0,1,1, "DEMO 5 FOR MAXICODE"
PRINT 1

```

Result

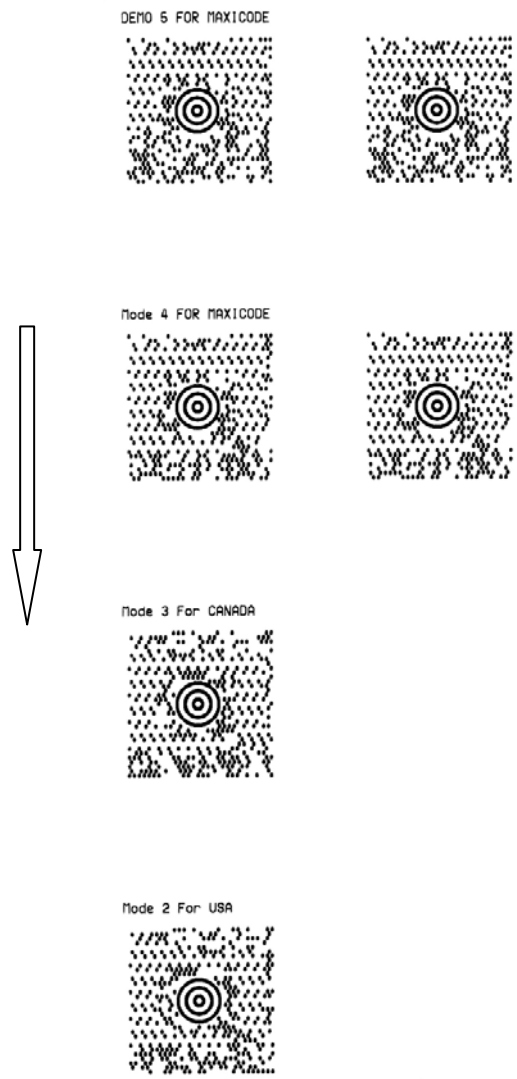

● PDF417

Description

This command defines a PDF417 2D bar code.

Syntax

PDF417 x,y,width,height,rotate,[option], "content"

<u>Parameter</u>	<u>Description</u>																				
x	X-coordinate of starting point (in dot)																				
y	Y-coordinate of starting point (in dot)																				
width	Expected width (in dots)																				
height	Expected height (in dots)																				
rotate	Rotation counterclockwise 0 : No rotation 90 : Rotate 90 degrees 180 : Rotate 180 degrees 270 : Rotate 270 degrees																				
option	<table border="1"> <tr> <td>P</td> <td>Data compression method 0: Auto encoding 1: Binary mode</td> </tr> <tr> <td>E</td> <td>Error correction level (Range: 0~8)</td> </tr> <tr> <td>M</td> <td>Center pattern in barcode area 0: The pattern will print upper left justified the area 1: The pattern is printed middle of area</td> </tr> <tr> <td>Ux,y,c</td> <td>Human readable x: Human readable characters in the specified x-coordinate y: Human readable characters in the specified y-coordinate c: Maximum characters of human readable character per line</td> </tr> <tr> <td>W</td> <td>Module width in dot (Range: 2~9)</td> </tr> <tr> <td>H</td> <td>Bar height in dot (Range: 4~99)</td> </tr> <tr> <td>R</td> <td>Maximum number of rows</td> </tr> <tr> <td>C</td> <td>Maximum number of columns</td> </tr> <tr> <td>T</td> <td>Truncation 0: Not truncated 1: Truncated</td> </tr> <tr> <td>Lm</td> <td>Expression length, $1 \leq m \leq 2048$ (without " for content)</td> </tr> </table>	P	Data compression method 0: Auto encoding 1: Binary mode	E	Error correction level (Range: 0~8)	M	Center pattern in barcode area 0: The pattern will print upper left justified the area 1: The pattern is printed middle of area	Ux,y,c	Human readable x: Human readable characters in the specified x-coordinate y: Human readable characters in the specified y-coordinate c: Maximum characters of human readable character per line	W	Module width in dot (Range: 2~9)	H	Bar height in dot (Range: 4~99)	R	Maximum number of rows	C	Maximum number of columns	T	Truncation 0: Not truncated 1: Truncated	Lm	Expression length, $1 \leq m \leq 2048$ (without " for content)
P	Data compression method 0: Auto encoding 1: Binary mode																				
E	Error correction level (Range: 0~8)																				
M	Center pattern in barcode area 0: The pattern will print upper left justified the area 1: The pattern is printed middle of area																				
Ux,y,c	Human readable x: Human readable characters in the specified x-coordinate y: Human readable characters in the specified y-coordinate c: Maximum characters of human readable character per line																				
W	Module width in dot (Range: 2~9)																				
H	Bar height in dot (Range: 4~99)																				
R	Maximum number of rows																				
C	Maximum number of columns																				
T	Truncation 0: Not truncated 1: Truncated																				
Lm	Expression length, $1 \leq m \leq 2048$ (without " for content)																				
content	Content of PDF417 2D bar code Note: <i>If parameter Lm is used, double quotes (") are unnecessary for content.</i>																				

Example

Sample code	Result
<pre> SIZE 4,1 GAP 0,0 DIRECTION 1 REM *****WITHOUT OPTIONS***** CLS PDF417 50,50,400,200,0, "Without Options" PRINT 1,1 </pre>	
<pre> SIZE 4,1.5 GAP 0,0 DIRECTION 1 REM *****OPTION:E3***** CLS PDF417 50,50,400,200,0,E3, "Error correction level:3" PRINT 1,1 REM *****OPTION:E4***** CLS PDF417 50,50,400,200,0,E4, "Error correction level:4" PRINT 1,1 </pre>	
<pre> SIZE 4,1.5 GAP 0,0 DIRECTION 1 REM *****OPTION:E4 W4***** CLS PDF417 50,50,600,600,0,E4,W4, "Error correction level:4 module width 4 dots" PRINT 1,1 REM *****OPTION:E4 W4 H4***** CLS PDF417 50,50,600,600,0,E4,W4,H4, "Error correction level:4 module width 4 dots bar height 4 dots" PRINT 1,1 </pre>	
<pre> SIZE 4,1.5 GAP 0,0 DIRECTION 1 REM *****OPTION:E4 W4 H4 R40 C4 T1***** CLS PDF417 50,50,800,800,0,E4,W4,H4,R40,C4,T1, "Error correction level:4 Module Width 4 dots Bar Height 4 dots Maximum Number of Rows:5 Rows Maximum number of columns:90 Cols Truncation:1" PRINT 1,1 </pre>	

SIZE 4,2.5
GAP 0,0
DIRECTION 1

REM *****OPTION:P1 E4 M1
U50,300,50,W4,H4,R60,C4,T0,L297*****
CLS
PDF417
50,50,900,600,0,P1,E4,M1,U50,300,50,W4,H4,R60,C4,
T0,L297,Data compression method: P1
Error correction level: E4
Center pattern in barcode area: M1
Human Readable: Yes: U50,300,50
Module Width 4 dots: W4
Bar Height 4 dots: H4
Maximum Number of Rows: 60 Rows: R60
Maximum number of columns: 4 Cols: C4
Truncation:1: T0
Expression length:297: L297
PRINT 1,1



Data compression method: P1 Error correction level: E4 Center pattern in barcode area: M1 Human Readable: Yes: U50,300,50 Module Width 4 dots: W4 Bar Height 4 dots: H4 Maximum Number of Rows: 60 Rows: R60 Maximum number of columns: 4 Cols: C4 Truncation:1: T0 Expression length:297: L297

● AZTEC

Description

This command defines a AZTEC 2D bar code.

Syntax

AZTEC x,y,rotate,[size,]ecp,[flg,]menu,[multi,]rev,] "content"	Since V6.60EZ
AZTEC x,y,rotate,size,ecp,flg,menu,multi,rev,bytes,content	Since V6.91EZ

<u>Parameter</u>	<u>Description</u>
x	Horizontal start position (in dots)
y	Vertical start position (in dots)
rotate	Rotation 0 : No rotation 90 : Rotate 90 degrees 180 : Rotate 180 degrees 270 : Rotate 270 degrees
size	Element module size (1 to 20), default is 6
ecp	Error control (& symbol size/type) parameter 0 : default error correction level 1 to 99 : minimum error correction percentage 101 to 104 : 1 to 4-layer Compact symbol 201 to 232 : 1 to 32-layer Full-Range symbol 300 : a simple Aztec "Rune"
flg	0 : input message is straight bytes 1 : input uses "<Esc>n" for FLG(n), "<Esc><Esc>" for "<Esc>"
menu	Menu symbol (0 : no, 1 : yes), default is 0
multi	Number of symbols (1 to 26), default is 6
rev	Output to be reversed (0 : no, 1 : yes), default is 0
bytes	Length of content
content	Content of AZTEC 2D bar code
	Note: <i>If parameter bytes is used, double quotes (") are unnecessary.</i>

Example

<u>Sample Code</u>	<u>Result</u>
<pre> SIZE 4,2 GAP 0,0 CLS AZTEC 10,10,0,"ABCDEFGHJKLMNOPQRSTUVWXYZ0123456789" AZTEC 210,10,0,4,"ABCDEFGHJKLMNOPQRSTUVWXYZ0123456789" AZTEC 410,10,0,4,1,"ABCDEFGHJKLMNOPQRSTUVWXYZ0123456789" AZTEC 610,10,0,4,1,0,"ABCDEFGHJKLMNOPQRSTUVWXYZ0123456789" AZTEC 10,310,0,4,1,0,0,"ABCDEFGHJKLMNOPQRSTUVWXYZ0123456789" AZTEC 210,310,0,4,1,0,0,1,"ABCDEFGHJKLMNOPQRSTUVWXYZ0123456789" AZTEC 410,310,0,4,1,0,0,1,1,"ABCDEFGHJKLMNOPQRSTUVWXYZ0123456789" AZTEC 610,310,0,4,1,0,0,1,1,10,1234567890 PRINT 1 </pre>	

● MPDF417

Description

This command defines a Micro PDF 417 bar code.

Syntax

MPDF417 x,y,rotate,[Wn,][Hn,][Cn,] "content"

<u>Parameter</u>	<u>Description</u>
x	Horizontal start position (in dots)
y	Vertical start position (in dots)
rotate	Rotation 0 : No rotation 90 : Rotate 90 degrees 180 : Rotate 180 degrees 270 : Rotate 270 degrees
Wn	Optional. Module width in dot. Default is 1.
Hn	Optional. Module height in dot. Default is 10.
Cn	Optional. Number of columns. Once the parameter is set, the printer will calculate the proper rows for the barcode base on the content automatically. 0: Auto mode. 1: Column is 1 and the calculated suitable rows will be 11, 14, 17, 20, 24, and 28. 2: Column is 2 and the calculated suitable rows will be 8, 11, 14, 17, 20, 23 and 26. 3: Column is 3 and the calculated suitable rows will be 6, 8, 10, 12, 15, 20, 26, 32, 38 and 44. 4: Column is 4 and the calculated suitable rows will be 4, 6, 8, 10, 12, 15, 20, 26, 32, 38 and 44.
Content	Content of Micro PDF 417 bar code

Note:
This command has been supported since V6.61 EZ and later firmware.

Example

<u>Sample Code</u>
SIZE 4,1 GAP 0,0 CLS MPDF417 10,10,0, "ABCDEFGHJKLMNOPQRSTUVWXYZ0123456789 " MPDF417 110,10,0,W2, "ABCDEFGHJKLMNOPQRSTUVWXYZ0123456789 " MPDF417 210,10,0,W2,H3, "ABCDEFGHJKLMNOPQRSTUVWXYZ0123456789 " MPDF417 310,10,0,W2,H3,C3, "ABCDEFGHJKLMNOPQRSTUVWXYZ0123456789 " PRINT 1
<u>Result</u>

● PUTBMP

Description

This command prints BMP format images. The grayscale printing is for direct thermal mode only. Support 1-bit (monochrome) and 8-bit (256-color) BMP graphic only.

Syntax

PUTBMP x,y,"filename" [, bpp][, contrast]

Parameter	Description
x	The x-coordinate of the BMP format image
y	The y-coordinate of the BMP format image
filename	The downloaded BMP filename (Support ZPL *.GRF)
bpp	Optional. Bits per pixel of grayscale graphic. Default is 1. *Since V6.91EZ. 1: 1-bit (monochrome) graphic 8: 8-bit (256-color) graphic
contrast	Optional. Contrast of grayscale graphic. Default is 80. Suggested range is from 60 to 100. *Since V6.91EZ.

Note: TDP-643 Plus, TTP-243, TTP-342, TTP-244ME, TTP-342M and TTP-248M series are not supported this PUTBMP command.

Example

Downloading BMP file into printer by DiagTool

The screenshot shows the 'Diagnostic Tool 1.50' window. The 'File Manager' tab is active. In the 'File Download' section, 'File Type' is set to 'BMP', 'File Name' is 'SAMPLE.BMP', 'File Size' is '31882 Bytes', and 'Memory Device' is 'FLASH'. The 'Download' button is highlighted with a red box and the number 3. In the 'Interface' dropdown menu, 'USB' is selected, highlighted with a red box and the number 1. The 'File Information' section shows 'Physical Space' as 4096 KB and 'Free Space' as 2528 KB. The 'File Format' section has 'FLASH' selected. Below the screenshot is a small image of a purple leaf with water droplets.

Sample Code

SPEED 2
DENSITY 3

```
SIZE 4,1.5
GAP 0,0
DIRECTION 1
CLS
PUTBMP 10,10,"SAMPLE.BMP"
BLOCK 10,180,240,100,"2",0,1,1,"bpp and contrast are omitted."
PUTBMP 300,10, "SAMPLE.BMP",1,80
BLOCK 300,180,240,100,"2",0,1,1, "bpp = 1
contrast = 80"
PUTBMP 590,10, "SAMPLE.BMP",8,80
BLOCK 590,180,240,100,"2",0,1,1,"bpp = 8
contrast = 80"
PRINT 1
```

Result



bpp and contrast
are omitted.

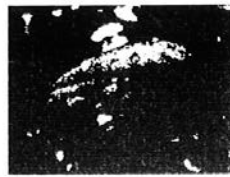

bpp = 1
contrast = 80



bpp = 8
contrast = 80

Sample Code

```
SIZE 2,2
GAP 0,0
CLS
PUTBMP 10,10, "SAMPLE.GRF"
PRINT 1
```

See Also

DOWNLOAD, BITMAP, PUTPCX

● PUTPCX

Description

This command prints PCX format images. TSPL language supports 2-color PCX format graphics. TSPL2 language supports 256-color PCX format graphics.

Note: Please refer to [printer model list](#) for checking TSPL or TSPL2.

Syntax

PUTPCX x,y, "filename"

<u>Parameter</u>	<u>Description</u>
x	The X-coordinate of the PCX format image
y	The Y-coordinate of the PCX format image
filename	The downloaded PCX file name (Case sensitive)

Example

Downloading PCX file into printer by DiagTool

Diagnostic Tool 1.50

Language: English Unit: inch mm

Interface: USB

Printer Configuration | **File Manager** | Bitmap Font Manager | Command Tool

File Download

File Type: PCX

Browse

File Name: SAMPLE.PCX

File Size: 31882 Bytes

Memory Device: FLASH

Font View Download

File Information

Memory Device: DRAM FLASH CARD

SAMPLE.PCX

Physical Space: 4096 KB

Free Space: 2528 KB

Get

File Format

Memory Device: DRAM FLASH CARD

Format

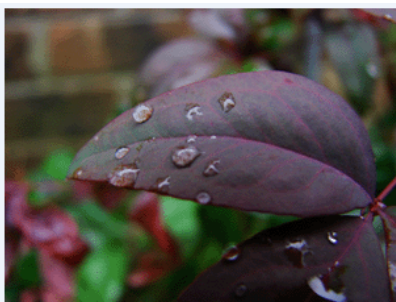

Sample Code

```
SPEED 2
DENSITY 3
SIZE 4,1.5
GAP 0,0
DIRECTION 1
CLS
PUTBMP 10,10, "SAMPLE.PCX"
PRINT 1
```

Result

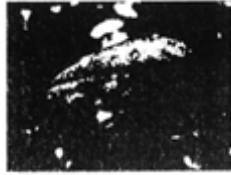

See Also

DOWNLOAD, BITMAP, PUTPCX

● QRCODE

Description

This command prints QR code.

Syntax

QRCODE x,y,ECC Level,cell width,mode,rotation,[justification,]model,]mask,]area] "content"

<u>Parameter</u>	<u>Description</u>															
x	The upper left corner x-coordinate of the QR code															
y	The upper left corner y-coordinate of the QR code															
ECC level	Error correction recovery level L : 7% M : 15% Q : 25% H : 30%															
cell width	1~10															
mode	Auto / manual encode A : Auto M : Manual															
rotation	0 : 0 degree 90 : 90 degree 180 : 180 degree 270 : 270 degree															
[justification]	Barcode justification (J1 to J9 valid; refer to "Sample code" example below); since version A1.97 firmware.															
[model]	M1: (default), original version M2: enhanced version (Almost smart phone is supported by this version.)															
[mask]	S0~S8, default is S7															
[area]	Maximum size of barcode area (Xdots; ex: X100); since version A1.97 firmware.															
content	The encodable character set is described as below, Encodable character set: 1) Numeric data: (digits 0~9) 2) Alphanumeric data Digits 0-9 Upper case letters A-Z Nine other characters: space, \$ % * + - . / :) 3) 8-bit byte data JIS 8-bit character set (Latin and Kana) in accordance with JIS X 0201 4) Kanji characters Shift JIS values 8140 _{HEX} -9FFC _{HEX} and E040 _{HEX} -EAA4 _{HEX} . These are values shifted from those of JIS X 0208. Refer to JIS X 0208 Annex 1 Shift Coded Representation for detail. Data characters per symbol (for maximum symbol size): <table border="1"> <thead> <tr> <th></th> <th>Model 1 (Version 14-L)</th> <th>Model 2 (Version 40-L)</th> </tr> </thead> <tbody> <tr> <td>Numeric data</td> <td>1,167 characters</td> <td>7,089 characters</td> </tr> <tr> <td>Alphanumeric data</td> <td>707 characters</td> <td>4,296 characters</td> </tr> <tr> <td>8-bit byte data</td> <td>486 characters</td> <td>2,953 characters</td> </tr> <tr> <td>Kanji data</td> <td>299 characters</td> <td>1,817 characters</td> </tr> </tbody> </table>		Model 1 (Version 14-L)	Model 2 (Version 40-L)	Numeric data	1,167 characters	7,089 characters	Alphanumeric data	707 characters	4,296 characters	8-bit byte data	486 characters	2,953 characters	Kanji data	299 characters	1,817 characters
	Model 1 (Version 14-L)	Model 2 (Version 40-L)														
Numeric data	1,167 characters	7,089 characters														
Alphanumeric data	707 characters	4,296 characters														
8-bit byte data	486 characters	2,953 characters														
Kanji data	299 characters	1,817 characters														
	* If "A" is the first character in the data string, then the following data after "A" is alphanumeric data.															

- *If "N" is the first character in the data string, then the following data after "N" is numeric data.
- *If "B" is the first character in the data string, then the following 4 digits after "B" is used to specify numbers of data. After the 4 digits is the number of bytes of binary data to be encoded.
- *If "K" is the first character in the data string, then the following data after "K" is Kanji data.
- *If "!" is in the data string and follows by "N", "A", "B", "K" then it will be switched to specified encodable character set.

Manual mode example:

QRCODE 100,10,L,7,M,0,M1,S1, "ATHE FIRMWARE HAS BEEN UPDATED"

(Where A: Alphanumeric data)

QRCODE 100,10,M,7,M,0,M1,S2, "N123456"

(Where N: Numeric data)

QRCODE 100,10,Q,7,M,0,M1,S3, "N123456!ATHE FIRMWARE HAS BEEN UPDATED"

(Where N: Numeric data ; !:Transfer char ; A: Alphanumeric data)

QRCODE 100,10,H,7,M,0,M1,S3, "B0012Product name"

(where B: Binary data ; 0012: 12 bytes)

QRCODE 100,10,M,7,M,0,M1,S3, "K"

(Where K: Kanji data)



Auto mode example:



QRCODE 100,10,M,7,A,0, "THE FIRMWARE HAS BEEN UPDATED"



Note: TDP-643 Plus, TTP-243, TTP-342, TTP-244ME, TTP-342M and TTP-248M series are not supported this QRCODE command.

Example

Sample code	Result
Auto mode example	
<u>General data string</u> SIZE 4,2.5 GAP 0,0 DIRECTION 1 CLS QRCODE 10,10,H,4,A,0, "ABCabc123" QRCODE 160,160,H,4,A,0, "123ABCabc" QRCODE 310,310,M,4,A,0,M2, "印表機 ABCabc123" PRINT 1,1	

<p><u>Data string including <Enter> character (0Dh, 0Ah)</u></p> <p>SIZE 4,2.5 GAP 0,0 DIRECTION 1 CLS QRCODE 10,10,H,4,A,0, "ABC<Enter> abc<Enter> 123 " QRCODE 160,160,H,4,A,0, "123<Enter> ABC<Enter> abc" QRCODE 310,310,H,4,A,0, "印表機<Enter> ABC<Enter> abc<Enter> 123" PRINT 1,1</p>	
<p><u>Data string concatenation (Must be used with DOWNLOAD ... EOP command)</u></p> <p>DOWNLOAD "DEMO.BAS" SIZE 4,2.5 GAP 0,0 DIRECTION 1 CLS QRCODE 10,10,H,4,A,0, "ABCabc123" +STR\$(1234) QRCODE 160,160,H,4,A,0, "123ABCabc" +"1234" QRCODE 310,310,H,4,A,0, "印表機 ABCabc123"+"1234"+"abcd" PRINT 1,1 EOP DEMO</p>	
<p><u>Data string including double quote (") character, please use \" instead of</u></p> <p>SIZE 4,2.5 GAP 0,0 DIRECTION 1 CLS QRCODE 10,10,H,4,A,0, "ABC\"abc\"123" QRCODE 160,160,H,4,A,0, "123\"ABC\"abc" QRCODE 310,310,H,4,A,0, "\"印表機\"ABCabc123" PRINT 1,1</p>	

Manual mode	
<p><u>General data string</u> SIZE 4,2.5 GAP 0,0 DIRECTION 1 CLS QRCODE 10,10,H,4,M,0, "AABC!B0003abc!N123" QRCODE 160,160,H,4,M,0, "N123!AABC!B0003abc" QRCODE 310,310,H,4,M,0, "K 印表機!AABC!B0006abc123" PRINT 1,1</p>	
<p><u>Data string including <Enter> character, <Enter> is an 8-bit byte data</u> SIZE 4,2.5 GAP 0,0 DIRECTION 1 CLS QRCODE 10,10,H,4,M,0,"AABC!B0007<Enter> abc<Enter> !N123" QRCODE 160,160,H,4,M,0,"N123!B0002<Enter> !AABC!B0005<Enter> abc" QRCODE 310,310,H,4,M,0, "K 印表機!B0002<Enter> !AABC!B0010<Enter> abc<Enter> 123" PRINT 1,1</p>	
<p><u>Data string concatenation (Must be used with DOWNLOAD ... EOP command)</u> DOWNLOAD "A.BAS" SIZE 4,2.5 GAP 0,0 DIRECTION 1 CLS QRCODE 10,10,H,4,M,0,"AABC!B0006abc123!N"+STR\$(1234) QRCODE 160,160,H,4,M,0,"N123!AABC!B0007abc"+"1234" QRCODE 310,310,H,4,M,0, "K 印表機!AABC!B0014abc123"+"1234"+"abcd" PRINT 1,1 EOP A</p>	

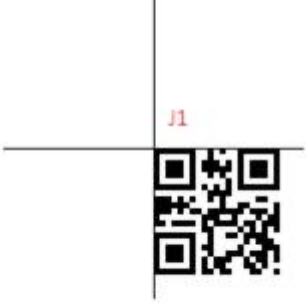
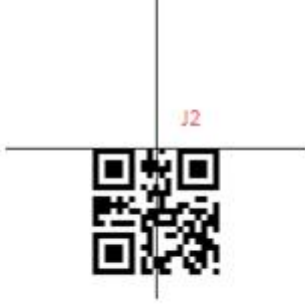
<p>Data string including double quote (") character, please use \" instead of</p> <p>SIZE 4,2.5 GAP 0,0 DIRECTION 1 CLS QRCODE 10,10,H,4,M,0, "AABC!B0005\"[\"]abc\"[\"]!N123" QRCODE 160,160,H,4,M,0, "N123!B0001\"[\"]!AABC!B0004\"[\"]abc" QRCODE 310,310,H,4,M,0, "B0001\"[\"]!K 印表機!B0010\"[\"]ABCabc123" PRINT 1,1</p>	
<p>Smart phone data string</p> <p>DOWNLOAD "A.BAS" SIZE 3,3 GAP 0,0 DIRECTION 1 CLS QRCODE 10,10,H,7,M,0,M2,S7,"Aabcd" QRCODE 170,170,H,4,M,0, M2,"B0008 繁體中文" QRCODE 300,300, L, 8, M, 0, M2,"B0026http://www.tscprinters.com" PRINT 1,1 EOP A</p>	
<p>Data string for parameter [justification] & [area]</p> <p>SIZE 4,2.5 GAP 0,0 DIRECTION 1 CLS BAR 60,120,200,1 BAR 160,20,1,200 QRCODE 160,120,H,10,A,0,X100,J5,"123456789" PRINT 1,1</p>	
<p>For other [justification] results (J1~J9)</p> <div style="display: flex; justify-content: space-around; align-items: center;"> <div data-bbox="201 1581 689 1944">  </div> <div data-bbox="730 1581 1219 1944">  </div> </div>	

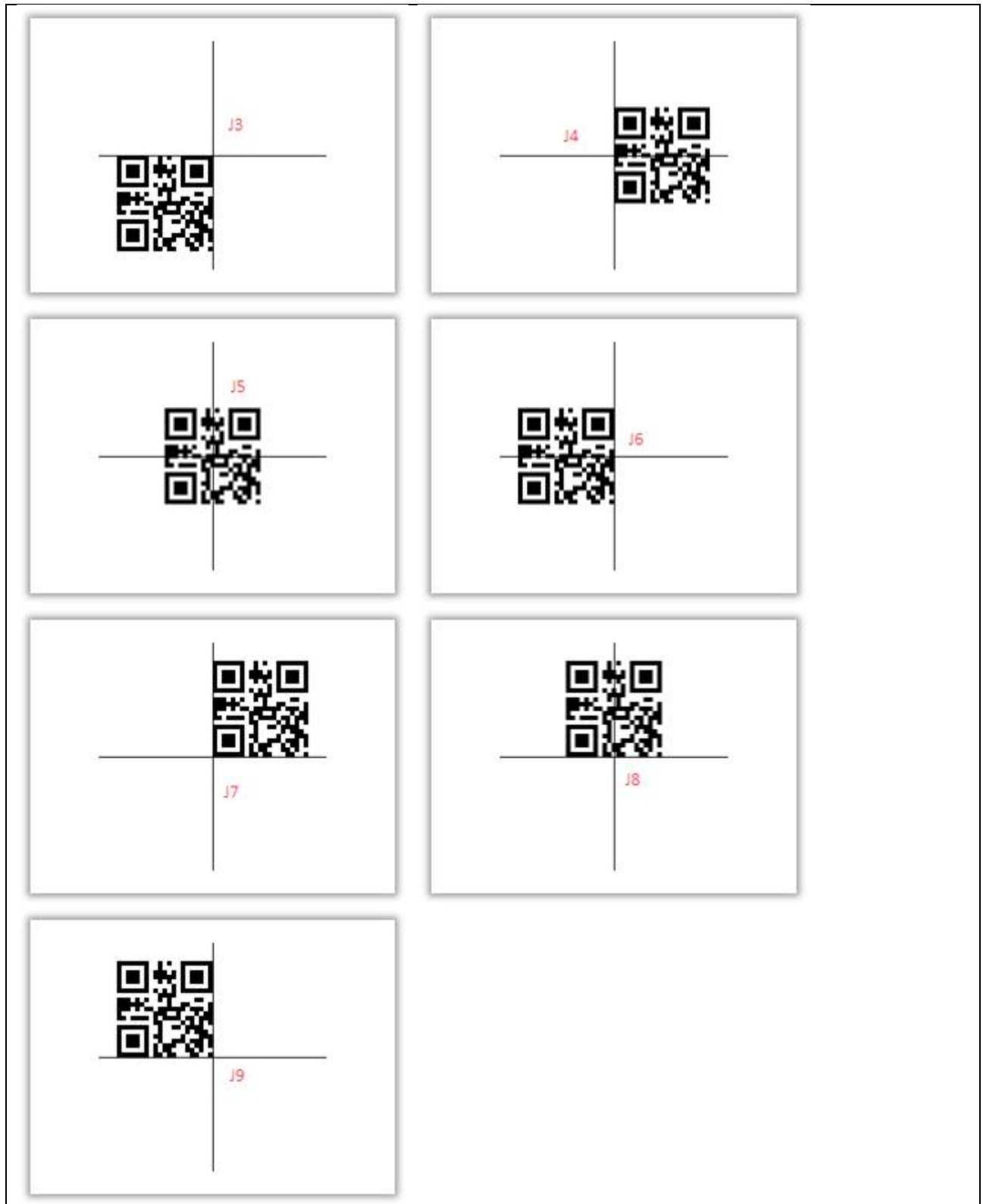

● RSS

Description

This command is used to draw a RSS bar code on the label format.

Syntax

RSS x,y,"sym",rotate,pixMult,sepHt,"content"

RSS x,y,"RSSEXP",rotate,pixMult,sepHt,segWidth,"content"





RSS x,y,"UCC128CCA",rotate,pixMult,sepHt,linHeight,"content"

RSS x,y,"UCC128CCC",rotate,pixMult,sepHt,linHeight,"content"

Parameter	Description																										
x	X-coordinate																										
y	Y-coordinate																										
sym	Symbology type: <table border="1" data-bbox="491 667 1141 1153"> <thead> <tr> <th></th> <th></th> </tr> </thead> <tbody> <tr> <td>RSS14</td> <td>RSS14</td> </tr> <tr> <td>RSS14T</td> <td>RSS14 Truncated</td> </tr> <tr> <td>RSS14S</td> <td>RSS14 Stacked</td> </tr> <tr> <td>RSS14SO</td> <td>RSS14 Stacked Omnidirectional</td> </tr> <tr> <td>RSSLIM</td> <td>RSS Limited</td> </tr> <tr> <td>RSSEXP</td> <td>RSS Expanded</td> </tr> <tr> <td>UPCA</td> <td>UPC-A</td> </tr> <tr> <td>UPCE</td> <td>UPC-E</td> </tr> <tr> <td>EAN13</td> <td>EAN-13</td> </tr> <tr> <td>EAN8</td> <td>EAN-8</td> </tr> <tr> <td>UCC128CCA</td> <td>UCC/EAN-128 & CC-A/B</td> </tr> <tr> <td>UCC128CCC</td> <td>UCC/EAN-128 & CC-C</td> </tr> </tbody> </table>			RSS14	RSS14	RSS14T	RSS14 Truncated	RSS14S	RSS14 Stacked	RSS14SO	RSS14 Stacked Omnidirectional	RSSLIM	RSS Limited	RSSEXP	RSS Expanded	UPCA	UPC-A	UPCE	UPC-E	EAN13	EAN-13	EAN8	EAN-8	UCC128CCA	UCC/EAN-128 & CC-A/B	UCC128CCC	UCC/EAN-128 & CC-C
RSS14	RSS14																										
RSS14T	RSS14 Truncated																										
RSS14S	RSS14 Stacked																										
RSS14SO	RSS14 Stacked Omnidirectional																										
RSSLIM	RSS Limited																										
RSSEXP	RSS Expanded																										
UPCA	UPC-A																										
UPCE	UPC-E																										
EAN13	EAN-13																										
EAN8	EAN-8																										
UCC128CCA	UCC/EAN-128 & CC-A/B																										
UCC128CCC	UCC/EAN-128 & CC-C																										
rotate	Rotation (0, 90, 180, and 270 valid)																										
pixMult	Module width in dot (1 to 10 valid) The following barcode height is calculated by printer. <table border="1" data-bbox="491 1279 1141 1619"> <thead> <tr> <th></th> <th></th> </tr> </thead> <tbody> <tr> <td>RSS14</td> <td>33 × pixMult</td> </tr> <tr> <td>RSS14T</td> <td>13 × pixMult.</td> </tr> <tr> <td>RSS14S</td> <td>13 × pixMult.</td> </tr> <tr> <td>RSS14SO</td> <td>33 × pixMult.</td> </tr> <tr> <td>RSSLIM</td> <td>13 × pixMult.</td> </tr> <tr> <td>RSSEXP</td> <td>33 × pixMult.</td> </tr> <tr> <td>EAN8</td> <td>60 × pixMult.</td> </tr> <tr> <td>EAN13</td> <td>74 × pixMult.</td> </tr> <tr> <td>UPCA</td> <td>74 × pixMult.</td> </tr> <tr> <td>UPCE</td> <td>74 × pixMult.</td> </tr> </tbody> </table>			RSS14	33 × pixMult	RSS14T	13 × pixMult.	RSS14S	13 × pixMult.	RSS14SO	33 × pixMult.	RSSLIM	13 × pixMult.	RSSEXP	33 × pixMult.	EAN8	60 × pixMult.	EAN13	74 × pixMult.	UPCA	74 × pixMult.	UPCE	74 × pixMult.				
RSS14	33 × pixMult																										
RSS14T	13 × pixMult.																										
RSS14S	13 × pixMult.																										
RSS14SO	33 × pixMult.																										
RSSLIM	13 × pixMult.																										
RSSEXP	33 × pixMult.																										
EAN8	60 × pixMult.																										
EAN13	74 × pixMult.																										
UPCA	74 × pixMult.																										
UPCE	74 × pixMult.																										
sepHt	Separator row height (1 and 2 valid) pixMult times sepHt is the real separator row height. It is calculated by printer.																										
segWidth	Segment width of RSS expanded (even 2 to 22 valid)																										
linHeight	UCC/EAN-128 height in dot (1 to 500 valid)																										
content	Barcode content or string expression Content of UPCE must be: *00abc0000hij = abhijc, where c = 0-2 *00abc00000ij = abcij3 *00abcd00000j = abcdj4 *00abcde0000j = abcdej where j = 5-9																										
Note:																											

- **200 DPI: 1 mm = 8 dots**
300 DPI: 1 mm = 12 dots
- **Recommended max. height of reversed black area is 12 mm at 4 " width. Height of reversed area that is larger than 12 mm may damage the power supply and affect the print quality.**
- **Max. print ratio is different for each printer model. Desktop and industrial printer print ratio is limited to 20% and 30% respectively.**
- **This command has been supported since V6.56 EZ and later firmware.**

Example

Sample code	Result
<pre> SIZE 100 mm,100 mm GAP 0,0 DIRECTION 1 CLS RSS 300,300, "RSS14",0,2,2, "1234567890 ABCDEFGF" RSS 300,300,"RSS14T",90,2,2,"1234567890 ABCDEFGF" RSS 300,300,"RSS14S",180,2,2,"1234567890 ABCDEFGF" RSS 300,300, "RSS14SO",270,2,2, "1234567890 ABCDEFGF" PRINT 1,1 </pre>	
<pre> SIZE 100 mm,100 mm GAP 0,0 DIRECTION 1 CLS RSS 300,300, "RSSLIM",0,2,2, "1234567890 ABCDEFGF" RSS 300,300, "RSSEXP",90,2,2,22, "1234567890 ABCDEFGF" RSS 300,300, "UPCA",180,2,2, "1234567890 ABCDEFGF" RSS 300,300, "UPCE",270,2,2, "000 ABCDEFGF" PRINT 1,1 </pre>	
<pre> SIZE 100 mm,100 mm GAP 0,0 DIRECTION 1 CLS RSS 300,300,"EAN13",0,2,2,"123456789012 ABCDEFGF" RSS 300,300,"EAN8",90,2,2,"1234567 ABCDEFGF" RSS 300,300,"UCC128CCA",180,2,2,25,"1234567890 ABCDEFGF" RSS 300,300,"UCC128CCC",270,2,2,25,"1234567890 ABCDEFGF" PRINT 1,1 </pre>	
<pre> SIZE 100 mm, 100 mm GAP 0,0 DIRECTION 1 CLS RSS 300,10, "RSSEXP",90,2,2,12, "81101061414112345628911012012120850100480002140256100 48000310123191000" PRINT 1 </pre>	

Example of UPCE mode	
<p>SIZE 4,1 GAP 0,0 DIRECTION 1 CLS REM UPCE Rule 1: 00abc000hij = abhijc, where c = 0-2 RSS 10,10,"UPCE",0,2,2,"00120000456 ABCDEFGF" RSS 210,10,"UPCE",0,2,2,"001210000456 ABCDEFGF" RSS 410,10,"UPCE",0,2,2,"001220000456 ABCDEFGF" PRINT 1</p>	
<p>SIZE 4,1 GAP 0,0 DIRECTION 1 CLS REM UPCE Rule 2: 00abc0000ij = abcij3 RSS 10,10,"UPCE",0,2,2,"001230000045 ABCDEFGF" PRINT 1 SIZE 4,1 CLS REM UPCE Rule 3: 00abcd0000j = abcdj4 RSS 10,10,"UPCE",0,2,2,"001234000005 ABCDEFGF" PRINT 1</p>	
<p>SIZE 4,1 GAP 0,0 DIRECTION 1 CLS REM UPCE Rule 4: 00abcde000j = abcdej where j = 5-9 RSS 10,10,"UPCE",0,2,2,"001234500005 ABCDEFGF" RSS 160,10,"UPCE",0,2,2,"001234500006 ABCDEFGF" RSS 310,10,"UPCE",0,2,2,"001234500007 ABCDEFGF" RSS 460,10,"UPCE",0,2,2,"001234500008 ABCDEFGF" RSS 610,10,"UPCE",0,2,2,"001234500009 ABCDEFGF" PRINT 1</p>	
Example of barcode height of EAN8 EAN13 UPCA and UPCE.	
<p>SIZE 4,2 GAP 0,0 DIRECTION 1 CLS RSS 10,10,"EAN8",0,1,1,"1234567 ABCDEFGF" RSS 210,10,"EAN8",0,2,1,"1234567 ABCDEFGF" RSS 410,10,"EAN8",0,3,1,"1234567 ABCDEFGF" PRINT 1</p>	
<p>SIZE 4,2 GAP 0,0 DIRECTION 1 CLS RSS 10,10,"EAN13",0,1,1,"123456789012 ABCDEFGF" RSS 210,10,"EAN13",0,2,1,"123456789012 ABCDEFGF" RSS 410,10,"EAN13",0,3,1,"123456789012 ABCDEFGF" PRINT 1</p>	

<p> SIZE 4,2 GAP 0,0 DIRECTION 1 CLS RSS 10,10,"UPCA",0,1,1,"12345678901 ABCDEFGH" RSS 210,10,"UPCA",0,2,1,"12345678901 ABCDEFGH" RSS 410,10,"UPCA",0,3,1,"12345678901 ABCDEFGH" PRINT 1 </p>	
<p> SIZE 4,2 GAP 0,0 DIRECTION 1 CLS RSS 10,10,"UPCE",0,1,1,"001200000456 ABCDEFGH" RSS 210,10,"UPCE",0,2,1,"001210000456 ABCDEFGH" RSS 410,10,"UPCE",0,3,1,"001220000456 ABCDEFGH" PRINT 1 </p>	

● REVERSE

Description

This command reverses a region in image buffer.

Syntax

REVERSE x_start,y_start,x_width,y_height

<u>Parameter</u>	<u>Description</u>
x_start	The x-coordinate of the starting point (in dots)
y_start	The y-coordinate of the starting point (in dots)
x_width	X-axis region width (in dots)
y_height	Y-axis region height (in dots)

Note:

- **200 DPI : 1 mm = 8 dots**
300 DPI : 1 mm = 12 dots
- **Recommended max. height of reversed black area is 12mm at 4" width. Height of reversed area that is larger than 12 mm may damage the power supply and affect the print quality.**
- **Max. print ratio is different for each printer model. Desktop and industrial printer print ratio is limited to 20% and 30% respectively.**

Example

<u>Sample code</u>	<u>Result</u>
<pre>SIZE 4,2.5 GAP 0,0 DIRECTION 1 CLS TEXT 100,100,"3",0,1,1,"REVERSE" REVERSE 90,90,128,40 PRINT 1,1</pre>	

● DIAGONAL

Description

This command is used to draw a diagonal.

Syntax

DIAGONAL x1, y1, x2, y2, thickness

<u>Parameter</u>	<u>Description</u>
x1	The x1-coordinate of the starting point (in dots)
y1	The y1-coordinate of the starting point (in dots)
x2	The x2-coordinate of the ending point (in dots)
y2	The y2-coordinate of the ending point (in dots)
thickness	Thickness of diagonal

Note:

- **200 DPI : 1 mm = 8 dots**
- **300 DPI : 1 mm = 12 dots**

Example

<u>Sample code</u>	<u>Result</u>
<pre>SIZE 4,2.5 GAP 0,0 DIRECTION 1 CLS DIAGONAL 50, 200, 200, 50, 16 DIAGONAL 50, 500, 500, 50, 8 PRINT 1,1</pre>	

● TEXT

Description

This command prints text on label.

Syntax

TEXT x,y, " font ",rotation,x-multiplication,y-multiplication,[alignment,] " content "

<u>Parameter</u>	<u>Description</u>																																																
x	The x-coordinate of the text																																																
y	The y-coordinate of the text																																																
font	Font name <table border="1" data-bbox="491 600 1347 1644"> <tbody> <tr> <td>0</td> <td>Monotype CG Triumvirate Bold Condensed, font width and height is stretchable</td> </tr> <tr> <td>1</td> <td>8 x 12 fixed pitch dot font</td> </tr> <tr> <td>2</td> <td>12 x 20 fixed pitch dot font</td> </tr> <tr> <td>3</td> <td>16 x 24 fixed pitch dot font</td> </tr> <tr> <td>4</td> <td>24 x 32 fixed pitch dot font</td> </tr> <tr> <td>5</td> <td>32 x 48 dot fixed pitch font</td> </tr> <tr> <td>6</td> <td>14 x 19 dot fixed pitch font OCR-B</td> </tr> <tr> <td>7</td> <td>21 x 27 dot fixed pitch font OCR-B</td> </tr> <tr> <td>8</td> <td>14 x25 dot fixed pitch font OCR-A</td> </tr> <tr> <td>ROMAN.TTF</td> <td>Monotype CG Triumvirate Bold Condensed, font width and height proportion is fixed.</td> </tr> <tr> <td colspan="2"><i>Following fonts were supported since V6.80 EZ.</i></td> </tr> <tr> <td>1.EFT</td> <td>EPL2 font 1</td> </tr> <tr> <td>2.EFT</td> <td>EPL2 font 2</td> </tr> <tr> <td>3.EFT</td> <td>EPL2 font 3</td> </tr> <tr> <td>4.EFT</td> <td>EPL2 font 4</td> </tr> <tr> <td>5.EFT</td> <td>EPL2 font 5</td> </tr> <tr> <td>A.FNT</td> <td>ZPL2 font A</td> </tr> <tr> <td>B.FNT</td> <td>ZPL2 font B</td> </tr> <tr> <td>D.FNT</td> <td>ZPL2 font D</td> </tr> <tr> <td>E8.FNT</td> <td>ZPL2 font E8</td> </tr> <tr> <td>F.FNT</td> <td>ZPL2 font F</td> </tr> <tr> <td>G.FNT</td> <td>ZPL2 font G</td> </tr> <tr> <td>H8.FNT</td> <td>ZPL2 font H8</td> </tr> <tr> <td>GS.FNT</td> <td>ZPL2 font GS</td> </tr> </tbody> </table>	0	Monotype CG Triumvirate Bold Condensed, font width and height is stretchable	1	8 x 12 fixed pitch dot font	2	12 x 20 fixed pitch dot font	3	16 x 24 fixed pitch dot font	4	24 x 32 fixed pitch dot font	5	32 x 48 dot fixed pitch font	6	14 x 19 dot fixed pitch font OCR-B	7	21 x 27 dot fixed pitch font OCR-B	8	14 x25 dot fixed pitch font OCR-A	ROMAN.TTF	Monotype CG Triumvirate Bold Condensed, font width and height proportion is fixed.	<i>Following fonts were supported since V6.80 EZ.</i>		1.EFT	EPL2 font 1	2.EFT	EPL2 font 2	3.EFT	EPL2 font 3	4.EFT	EPL2 font 4	5.EFT	EPL2 font 5	A.FNT	ZPL2 font A	B.FNT	ZPL2 font B	D.FNT	ZPL2 font D	E8.FNT	ZPL2 font E8	F.FNT	ZPL2 font F	G.FNT	ZPL2 font G	H8.FNT	ZPL2 font H8	GS.FNT	ZPL2 font GS
0	Monotype CG Triumvirate Bold Condensed, font width and height is stretchable																																																
1	8 x 12 fixed pitch dot font																																																
2	12 x 20 fixed pitch dot font																																																
3	16 x 24 fixed pitch dot font																																																
4	24 x 32 fixed pitch dot font																																																
5	32 x 48 dot fixed pitch font																																																
6	14 x 19 dot fixed pitch font OCR-B																																																
7	21 x 27 dot fixed pitch font OCR-B																																																
8	14 x25 dot fixed pitch font OCR-A																																																
ROMAN.TTF	Monotype CG Triumvirate Bold Condensed, font width and height proportion is fixed.																																																
<i>Following fonts were supported since V6.80 EZ.</i>																																																	
1.EFT	EPL2 font 1																																																
2.EFT	EPL2 font 2																																																
3.EFT	EPL2 font 3																																																
4.EFT	EPL2 font 4																																																
5.EFT	EPL2 font 5																																																
A.FNT	ZPL2 font A																																																
B.FNT	ZPL2 font B																																																
D.FNT	ZPL2 font D																																																
E8.FNT	ZPL2 font E8																																																
F.FNT	ZPL2 font F																																																
G.FNT	ZPL2 font G																																																
H8.FNT	ZPL2 font H8																																																
GS.FNT	ZPL2 font GS																																																
rotation	The rotation angle of text 0 : No rotation 90: degrees, in clockwise direction 180 : degrees, in clockwise direction 270 : degrees, in clockwise direction																																																
x-multiplication	Horizontal multiplication, up to 10x Available factors: 1~10 For "ROMAN.TTF" true type font, this parameter is ignored. For font "0", this parameter is used to specify the width (point) of true type font. 1 point=1/72 inch.																																																

y-multiplication	Vertical multiplication, up to 10x Available factors: 1~10 For true type font, this parameter is used to specify the height (point) of true type font. 1 point=1/72 inch. For *.TTF font, x-multiplication and y-multiplication support floating value. (V6.91 EZ)
alignment	Optional. Specify the alignment of text. (V6.73 EZ) 0 : Default (Left) 1 : Left 2 : Center 3 : Right
content	Content of text string

Note:

- **The internal font (font #1~#5) pitch between TSPL and TSPL2 is different.**
- **Font "0" and "ROMAN.TTF" internal True Type Fonts are available in TSPL2 language printers, but not TSPL language printers.**
- **Please refer to [printer model list](#) for checking TSPL or TSPL2.**
- **If there is any double quote (") within the text, please change it to \["].**
- **If font "0" is used, the font width and font height is stretchable by x-multiplication and y-multiplication parameter. It is expressed by pt (point). 1 point=1/72inch.**
- **EPL2 and ZPL2 are emulating for Eltron[®] and Zebra[®] languages.**

MODEL	Font Type									
	0	1	2	3	4	5	6	7	8	ROMAN.TTF
TSPL language printers		V	V	V	V	V				
TSPL2 language printers	V	V	V	V	V	V	V	V	V	V
TTP-248M printer		V	V	V	V	V	V	V		V

Example

Sample Code

```

SIZE 4,3
GAP 0,0
DIRECTION 1
CLS
TEXT 10,10,"0",0,12,12,"TSPL 2"
TEXT 10,40,"0",0,8,8,"align left"
BAR 0,70,800,4
TEXT 10,110,"0",0,12,12,"FONT 0"
TEXT 10,160,"1",0,1,1,"FONT 1"
TEXT 10,210,"2",0,1,1,"FONT 2"
TEXT 10,260,"3",0,1,1,0,"FONT 3"
TEXT 10,310,"4",0,1,1,0,"FONT 4"
TEXT 10,360,"5",0,1,1,0,"FONT 5"
TEXT 10,410,"6",0,1,1,1,"FONT 6"
TEXT 10,460,"7",0,1,1,1,"FONT 7"
TEXT 10,510,"8",0,1,1,1,"FONT 8"
TEXT 10,560,"ROMAN.TTF",0,12,12,"FONT ROMAN.TTF"

TEXT 400,10,"0",0,12,12,2,"EPL 2"
TEXT 400,40,"0",0,8,8,2,"align center"
TEXT 400,110,"1.EFT",0,1,1,2,"FONT 1"
TEXT 400,160,"2.EFT",0,1,1,2,"FONT 2"
TEXT 400,210,"3.EFT",0,1,1,2,"FONT 3"
TEXT 400,260,"4.EFT",0,1,1,2,"FONT 4"
TEXT 400,310,"5.EFT",0,1,1,2,"FONT 5"

TEXT 800,10,"0",0,12,12,3,"ZPL 2"
TEXT 800,40,"0",0,8,8,3,"align right"
TEXT 800,110,"A.FNT",0,1,1,3,"FONT A"
TEXT 800,160,"B.FNT",0,1,1,3,"FONT B"
TEXT 800,210,"D.FNT",0,1,1,3,"FONT D"
TEXT 800,260,"E8.FNT",0,1,1,3,"FONT E8"
TEXT 800,310,"F.FNT",0,1,1,3,"FONT F"
TEXT 800,360,"G.FNT",0,1,1,3,"FONT G"
TEXT 800,410,"H8.FNT",0,1,1,3,"FONT H8"
TEXT 800,460,"GS.FNT",0,1,1,3,"ABCDEF"
PRINT 1

```

Result

TSPL 2 align left	EPL 2 align center	ZPL 2 align right
FONT 0	FONT 1	FONT A
FONT 1	FONT 2	FONT B
FONT 2	FONT 3	FONT D
FONT 3	FONT 4	FONT E8
FONT 4	FONT 5	FONT F
FONT 5	FONT 6	FONT G
FONT 6		FONT H8
FONT 7		© © TM UL SR ©
FONT 8		
FONT ROMAN.TTF		

● BLOCK

Description

This command prints paragraph on label.

Syntax

BLOCK x,y,width,height, "font",rotation,x-multiplication,y-multiplication,[space,]align,]fit,]
"content"

<u>Parameter</u>	<u>Description</u>																																																
x	The x-coordinate of the text																																																
y	The y-coordinate of the text																																																
width	The width of block for the paragraph in dots																																																
height	The height of block for the paragraph in dots																																																
font	Font name																																																
	<table border="1"> <tr> <td>0</td> <td>Monotype CG Triumvirate Bold Condensed, font width and height is stretchable</td> </tr> <tr> <td>1</td> <td>8 x 12 fixed pitch dot font</td> </tr> <tr> <td>2</td> <td>12 x 20 fixed pitch dot font</td> </tr> <tr> <td>3</td> <td>16 x 24 fixed pitch dot font</td> </tr> <tr> <td>4</td> <td>24 x 32 fixed pitch dot font</td> </tr> <tr> <td>5</td> <td>32 x 48 dot fixed pitch font</td> </tr> <tr> <td>6</td> <td>14 x 19 dot fixed pitch font OCR-B</td> </tr> <tr> <td>7</td> <td>21 x 27 dot fixed pitch font OCR-B</td> </tr> <tr> <td>8</td> <td>14 x25 dot fixed pitch font OCR-A</td> </tr> <tr> <td>ROMAN.TTF</td> <td>Monotype CG Triumvirate Bold Condensed, font width and height proportion is fixed.</td> </tr> <tr> <td colspan="2"><i>Following fonts were supported since V6.80 EZ.</i></td> </tr> <tr> <td>1.EFT</td> <td>EPL2 font 1</td> </tr> <tr> <td>2.EFT</td> <td>EPL2 font 2</td> </tr> <tr> <td>3.EFT</td> <td>EPL2 font 3</td> </tr> <tr> <td>4.EFT</td> <td>EPL2 font 4</td> </tr> <tr> <td>5.EFT</td> <td>EPL2 font 5</td> </tr> <tr> <td>A.FNT</td> <td>ZPL2 font A</td> </tr> <tr> <td>B.FNT</td> <td>ZPL2 font B</td> </tr> <tr> <td>D.FNT</td> <td>ZPL2 font D</td> </tr> <tr> <td>E8.FNT</td> <td>ZPL2 font E8</td> </tr> <tr> <td>F.FNT</td> <td>ZPL2 font F</td> </tr> <tr> <td>G.FNT</td> <td>ZPL2 font G</td> </tr> <tr> <td>H8.FNT</td> <td>ZPL2 font H8</td> </tr> <tr> <td>GS.FNT</td> <td>ZPL2 font GS</td> </tr> </table>	0	Monotype CG Triumvirate Bold Condensed, font width and height is stretchable	1	8 x 12 fixed pitch dot font	2	12 x 20 fixed pitch dot font	3	16 x 24 fixed pitch dot font	4	24 x 32 fixed pitch dot font	5	32 x 48 dot fixed pitch font	6	14 x 19 dot fixed pitch font OCR-B	7	21 x 27 dot fixed pitch font OCR-B	8	14 x25 dot fixed pitch font OCR-A	ROMAN.TTF	Monotype CG Triumvirate Bold Condensed, font width and height proportion is fixed.	<i>Following fonts were supported since V6.80 EZ.</i>		1.EFT	EPL2 font 1	2.EFT	EPL2 font 2	3.EFT	EPL2 font 3	4.EFT	EPL2 font 4	5.EFT	EPL2 font 5	A.FNT	ZPL2 font A	B.FNT	ZPL2 font B	D.FNT	ZPL2 font D	E8.FNT	ZPL2 font E8	F.FNT	ZPL2 font F	G.FNT	ZPL2 font G	H8.FNT	ZPL2 font H8	GS.FNT	ZPL2 font GS
0	Monotype CG Triumvirate Bold Condensed, font width and height is stretchable																																																
1	8 x 12 fixed pitch dot font																																																
2	12 x 20 fixed pitch dot font																																																
3	16 x 24 fixed pitch dot font																																																
4	24 x 32 fixed pitch dot font																																																
5	32 x 48 dot fixed pitch font																																																
6	14 x 19 dot fixed pitch font OCR-B																																																
7	21 x 27 dot fixed pitch font OCR-B																																																
8	14 x25 dot fixed pitch font OCR-A																																																
ROMAN.TTF	Monotype CG Triumvirate Bold Condensed, font width and height proportion is fixed.																																																
<i>Following fonts were supported since V6.80 EZ.</i>																																																	
1.EFT	EPL2 font 1																																																
2.EFT	EPL2 font 2																																																
3.EFT	EPL2 font 3																																																
4.EFT	EPL2 font 4																																																
5.EFT	EPL2 font 5																																																
A.FNT	ZPL2 font A																																																
B.FNT	ZPL2 font B																																																
D.FNT	ZPL2 font D																																																
E8.FNT	ZPL2 font E8																																																
F.FNT	ZPL2 font F																																																
G.FNT	ZPL2 font G																																																
H8.FNT	ZPL2 font H8																																																
GS.FNT	ZPL2 font GS																																																
rotation	<p>The rotation angle of text</p> <p>0 : No rotation</p> <p>90 : degrees, in clockwise direction</p> <p>180 : degrees, in clockwise direction</p> <p>270 : degrees, in clockwise direction</p>																																																
x-multiplication	<p>Horizontal multiplication, up to 10x</p> <p>Available factors: 1~10</p> <p>For "ROMAN.TTF" true type font, this parameter is ignored.</p>																																																

y-multiplication	For font "0", this parameter is used to specify the width (point) of true type font. 1 point=1/72 inch. Vertical multiplication, up to 10x Available factors: 1~10
[space]	For true type font, this parameter is used to specify the height (point) of true type font. 1 point=1/72 inch. For *.TTF font, x-multiplication and y-multiplication support floating value. (V6.91 EZ)
[align]	Add or delete the space between lines (in dots) Text alignment. (V6.73 EZ) 0 : default (Left) 1 : Left 2 : Center 3 : Right
[fit]	Shrink the text so that it fits in the block (VA1.97) 0 : No shrink (default) 1 : Shrink
content	Data in block. The maximum data length is 4092 bytes.

Note:

- *The internal font (font #1~#5) pitch between TSPL and TSPL2 is different.*
- *Font "0" and "ROMAN.TTF" internal True Type Fonts are available in TSPL2 language printers, but not TSPL language printers.*
- *If there is any double quote (") within the text, please change it to \["].*
- *If font "0" is used, the font width and font height is stretchable by x-multiplication and y-multiplication parameter. It is expressed by pt (point). 1 point=1/72inch.*
- *\[R] means carriage return character 0x0D.*
- *\[L] means line feed character 0x0A.*
- *This command has been supported since V6.91 EZ and later firmware.*
- *EPL2 and ZPL2 are for emulating Eltron® and Zebra® languages.*

Example

Sample Code	Result
<pre> SIZE 4,0.5 GAP 0,0 DIRECTION 1 CLS BOX 10,10,800,100,2 BLOCK 15,15,790,90,"0",0,8,8,"We stand behind our products with one of the most comprehensive support programs in the Auto-ID industry." PRINT 1 CLS BOX 10,10,800,100,2 BLOCK 15,15,790,90,"0",0,8,8,20,2,"We stand behind our products with one of the most comprehensive support programs in the Auto-ID industry." PRINT 1 </pre>	

Sample Code for [fit] Parameter

DATA\$ = "By more than a 2-1 ratio, lawmakers in West Virginia's House of Delegates have approved a bill that would allow gun owners to carry concealed handguns without a permit. The only concealed-carry permits would be for people who are 18-21 years old. Urging her colleagues to approve the bill, its 19-year-old sponsor, Delegate Saira Blair, "

SIZE 4,1.5
GAP 0,0
DIRECTION 1
CLS
BLOCK 20,20,500,170,"0",0,10,10,0,0,1,DATA\$
BOX 20,20,500+20,170+20,2
PRINT 1

SIZE 4,1.5
GAP 0,0
DIRECTION 1
CLS
BLOCK 20,20,500,170,"0",0,10,10,0,0,0,DATA\$
BOX 20,20,500+20,170+20,2
PRINT 1

Result

By more than a 2-1 ratio, lawmakers in West Virginia's House of Delegates have approved a bill that would allow gun owners to carry concealed handguns without a permit. The only concealed-carry permits would be for people who are 18-21 years old. Urging her colleagues to approve the bill, its 19-year-old sponsor, Delegate Saira Blair, "

By more than a 2-1 ratio, lawmakers in West Virginia's House of Delegates have approved a bill that would allow gun owners to carry concealed handguns without a permit. The only concealed-carry permits would be for people who are 18-21 years old. Urging her colleagues to approve the bill, its 19-year-old sponsor, Delegate Saira Blair, "

Status Polling and Immediate Commands

These commands support RS-232, USB and Ethernet.

● <ESC>!?

Description

This command obtains the printer status at any time, even in the event of printer error. An inquiry request is solicited by sending an <ESC> (ASCII 27, escape character) as the beginning control character to the printer. A one byte character is returned, flagging the printer status. A 0 signifies the printer is ready to print labels.

Syntax

<ESC>!?

Hex Receive	Printer Status
00	Normal
01	Head opened
02	Paper Jam
03	Paper Jam and head opened
04	Out of paper
05	Out of paper and head opened
08	Out of ribbon
09	Out of ribbon and head opened
0A	Out of ribbon and paper jam
0B	Out of ribbon, paper jam and head opened
0C	Out of ribbon and out of paper
0D	Out of ribbon, out of paper and head opened
10	Pause
20	Printing
80	Other error

See Also

<ESC>!S

● <ESC>!C

Description

This command restarts the printer and omits to run AUTO.BAS. The beginning of the command is an ESCAPE character (ASCII 27).

Syntax

<ESC>!C

Note:

- *When printer receives this command, printer will restart itself no matter AUTO.BAS exists or not.*
- *This command has been supported since V5.23 EZ and later firmware.*

See Also

<ESC>!Q

● <ESC>!D

Description

This command is used to disable immediate command, ex. <ESC>!R <RSC>!? <ESC>!C and so on, which is starting by <ESC>!. The beginning of the command is an ESCAPE character (ASCII 27).

Syntax

<ESC>!D

Note:

This command has been supported since V6.61 EZ and later firmware.

See Also

~!E

● <ESC>!O

Description

This command is used to cancel the PAUSE status of printer. The beginning of the command is an ESCAPE character (ASCII 27).

Syntax

<ESC>!O

Note:

This command has been supported since V6.93 EZ and later firmware.

See Also

<ESC>!P

● <ESC>!P

Description

This command is used to PAUSE the printer. The beginning of the command is an ESCAPE character (ASCII 27).

Syntax

<ESC>!P

Note:

This command has been supported since V6.93 EZ and later firmware.

See Also

<ESC>!O

● <ESC>!Q

Description

This command restarts the printer and omits to run AUTO.BAS. The beginning of the command is an ESCAPE character (ASCII 27).

Syntax

<ESC>!Q

Note:

- *If there is no AUTO.BAS inside the printer, the printer will not restart itself.*
- *This command has been supported since V6.72 EZ and later firmware.*

See Also

<ESC>!C

● <ESC>!R

Description

This command resets the printer. The beginning of the command is an ESCAPE character (ASCII 27). The files downloaded in memory will be deleted. This command cannot be sent in dump mode.

Syntax

<ESC>!R

See Also

<ESC>!?

● <ESC>!S

Description

This command obtains the printer status at any time, even in the event of printer error. An inquiry request is solicited by sending an <ESC> (ASCII 27, escape character) as the beginning control character to the printer. 8 bytes will be returned, flagging the printer status.

Syntax

<ESC>!S

Note:

This command has been supported since V6.29 EZ and later firmware.

Response Format

<STX>[4-byte status]<ETX><CR><LF>

Status Byte #1: message											
Bit 7	Bit 6	Bit 5	Bit 4	Bit 3	Bit 2	Bit 1	Bit 0	Hex	ASCII	Char	Meaning
0	1	0	0	0	0	0	0	40	64	@	Normal
0	1	1	0	0	0	0	0	60	96	`	Pause
0	1	0	0	0	0	1	0	42	66	B	Backing label
0	1	0	0	0	0	1	1	43	67	C	Cutting
0	1	0	0	0	1	0	1	45	69	E	Printer error
0	1	0	0	0	1	1	0	46	70	F	Form feed
0	1	0	0	1	0	1	1	4B	75	K	Waiting to press print key
0	1	0	0	1	1	0	0	4C	76	L	Waiting to take label
0	1	0	1	0	0	0	0	50	80	P	Printing batch
0	1	0	1	0	1	1	1	57	87	W	Imaging

Status Byte #2: warning											
Bit 7	Bit 6	Bit 5	Bit 4	Bit 3	Bit 2	Bit 1	Bit 0	Hex	ASCII	Char	Meaning
0	1	0	0	0	0	0	0	40	64	@	Normal
0	1	0	0	0	0	0	1	41	65	A	Paper low <small>(since A2.08 EZD)</small>
0	1	0	0	0	0	1	0	42	66	B	Ribbon low <small>(since A2.08 EZD)</small>
0	1	0	0	0	1	0	0	44	68	D	Reversed
0	1	0	0	1	0	0	0	48	72	H	Receive buffer full
0	1	1	0	0	0	0	0	60	96	`	Reversed

Status Byte #3: error											
Bit 7	Bit 6	Bit 5	Bit 4	Bit 3	Bit 2	Bit 1	Bit 0	Hex	ASCII	Char	Meaning
0	1	0	0	0	0	0	0	40	64	@	Normal
0	1	0	0	0	0	0	1	41	65	A	Print head overheat
0	1	0	0	0	0	1	0	42	66	B	Stepping motor overheat
0	1	0	0	0	1	0	0	44	68	D	Print head error <small>(since V7.01 EZ)</small>
0	1	0	0	1	0	0	0	48	72	H	Cutter jam
0	1	0	1	0	0	0	0	50	80	P	Insufficient memory

Status Byte #4: error											
Bit 7	Bit 6	Bit 5	Bit 4	Bit 3	Bit 2	Bit 1	Bit 0	Hex	ASCII	Char	Meaning
0	1	0	0	0	0	0	0	40	64	@	Normal
0	1	0	0	0	0	0	1	41	65	A	Paper empty
0	1	0	0	0	0	1	0	42	66	B	Paper jam
0	1	0	0	0	1	0	0	44	68	D	Ribbon empty
0	1	0	0	1	0	0	0	48	72	H	Ribbon jam
0	1	1	0	0	0	0	0	60	96	`	Print head open

Example

Test <ESC>!S by CommTool via RS-232 port.

The values return from printer in Hex.

The values return from printer in

Hex Data 1B 21 53 means <ESC>!S.

Click to send Hex 1b 21 53 to query

Result

02	40	40	40	40	03	0D	0A
02	46	40	40	40	03	0D	0A
02	60	40	40	40	03	0D	0A
02	42	40	40	40	03	0D	0A
02	45	40	40	42	03	0D	0A
02	45	40	40	62	03	0D	0A

1 2 3

@@@@
F@@@@
`@@@@
B@@@@
E@@@B
E@@@b

4

Item	Meaning
1	The start character of returned value.
2	The 4-byte status in Hex.
3	The end characters of returned value.
4	4-byte status in characters. @@@@: The printer is normal for use. F@@@@: The printer is feeding label. `@@@@: Printer is in PAUSE mode. B@@@@: The printer is backing label. E@@@B: Printer is in error "Paper Jam". E@@@b: Printer is in error "Paper Jam" & "Head open".

See Also

<ESC>!?

● <ESC>!F

Description

This command is used to feed a label. This function is the same as to press the FEED button. The beginning of the command is an ESCAPE character (ASCII 27).

Syntax

<ESC>!F

Note:

This command has been supported since V7.00 EZ and later firmware.

● <ESC>!. </h2>

Description

This command can cancel all printing files. The beginning of the command is an ESCAPE character (ASCII 27).

Syntax

<ESC>!.
</p></div>

Note:

This command has been supported since V7.00 EZ and later firmware.

● ~!@

Description

This command inquires the mileage of the printer. The integer part of mileage is returned (the decimal part of mileage is not return) to the PC in ASCII characters. The ending character of mileage is 0x0D.

Syntax

~!@

Example

~!@

● ~!A

Description

This command inquires the free memory of the printer. The number of bytes of free memory is returned in decimal digits, with 0x0d as ending code of PC.

Syntax

~!A

Example

~!A

See Also

FILES

● ~!C

Description

This command inquires the presence of Real Time Clock. One byte is return from the printer, indicating whether or not the RTC is installed. This command is only for the firmware before V6.xx.

Syntax

~!C

Return value	Description
0	RTC is not installed.
1	RTC is installed.

Example

~!C

● ~!D

Description

This command enters the printer into DUMP mode. In DUMP mode, the printer outputs code directly without interpretation.

Syntax

~!D

Example

~!D

● ~!E

Description

This command is used to enable immediate command, ex. <ESC>!R <RSC>!? <ESC>!C and so on, which is starting by <ESC>!.

Syntax

~!E

Note:

This command has been supported since V6.61 EZ and later firmware.

Example

~!E

See also

<ESC>!D

● ~!F

Description

This command inquires all about files resident in the printer memory, and fonts installed in the memory module. The filename are returned in ASCII characters. Each file name ends with 0x0D. The ending character is 0x1A. Entering this command multiple times will cycle through the files resident on memory.

Syntax

~!F

Example

~!F

See Also

FILES

● ~!!

Description

The command inquires the code page and country setting of the printer.

Syntax

~!!

The returned information is given in the following format:

code page, country code

ex : 8 bit : 437, 001

7 bit: USA, 001

Regarding the code pages and country codes supported by the printer, please refer to the **CODEPAGE** and **COUNTRY** command respectively.

Example

~!!

See Also

COUNTRY, CODEPAGE

● ~!T

Description

This command inquires the model name and number of the printer. This information is returned in ASCII characters.

Syntax

~ !T

Example

~!T

● <ESC> Y

Description

This command is used to enable line mode (from EZPL to CPCL) for EZC printer.

Syntax

<ESC> Y

Example

<ESC> Y

See Also

<ESC> Z

● <ESC> Z

Description

This command is used to disable line mode (from CPCL to EZPL) for EZC printer.

Syntax

<ESC> Z

Example

<ESC> Z

See Also

<ESC> Y

Message Translation Protocols

● ~#

Description

The beginning identifier (~#) of the prompt message is sent from the printer to the KP-200 portable keyboard. The ending identifier is ~&. @0 following the ending identifier ~& is used to instruct keyboard to display the prompt in the first line of LCD display. @1 following the ending identifier ~& is used to instruct keyboard to display the prompt in the first line of LCD display. If @0 or @1 are not present, prompt string will be displayed in first line of LCD and input data will be displayed in second line of LCD.

Syntax

~#Prompt~&[@0]

~#Prompt~&[@1]

Example

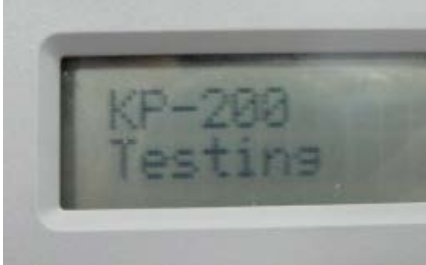
Sample code	Result
<pre>DOWNLOAD "A.BAS" OUT "~#KP-200~&@0" OUT "~#Testing~&@1" EOP A</pre>	

See Also

INPUT, OUT

Commands for Windows Driver

● !B

Description

This command stores bitmap image data in the memory. Behind the nnn is the bitmap data.

Syntax

!Bnnn

<u>Parameter</u>	<u>Description</u>
nnn	The number of bytes of image data sent from PC to printer, expressed in 3 decimal digits.

Example

!B100

See Also

BITMAP

● **!J**

Description

This command prints bitmap data at the specified position (in y-direction).

Syntax

!Jnnnn

<u>Parameter</u>	<u>Description</u>
nnn	Print image at the specified position in y-direction. The position is expressed in 4 decimal digits.

Example

!J0100

See Also

FEED

● !N

Description

This command prints a specified number of labels.

Syntax

!Nnnn

<u>Parameter</u>	<u>Description</u>
nnn	Specifies the number of copies to be printed.

Example

!N001

File Management Commands

● DOWNLOAD

Description

"DOWNLOAD" is a header of the file that is to be saved in the printer's memory. The downloaded files can be divided into two categories: program files and data files (including text data files, PCX graphic files and bitmap font files) The detailed descriptions regarding the download syntax for different files are as follows:

Maximum numbers of file saved in DRAM:

50 files for TSPL/TSPL2 language printers

Maximum numbers of file saved in Flash memory:

50 files for TSPL language printers

256 files for TSPL2 language printers

Please refer to [printer model list](#) for checking TSPL or TSPL2.

If "AUTO.BAS" exists in the printer memory, it will be automatically executed upon printer startup. To disable the auto execution function, please follow the procedures below.

Ignore AUTO.BAS
<u>For two buttons desktop printer series</u> Hold down the PAUSE and FEED buttons and turn on the printer power. Do not release the buttons until the three LEDs flash in turn. Printer will ignore AUTO.BAS and initialize the printer.
<u>For one button desktop printer series</u> Hold the FEED key and power on the switch. Release the FEED key while LED becomes solid green to prevent the printer from running "AUTO.BAS". The LED color will be changed as following pattern: *For firmware version before V3.37 printer: Orange → red (5 blinks) → orange (5 blinks) → green (5 blinks) → solid green *For firmware version after V3.37: Orange → red (5 blinks) → orange (5 blinks) → green (5 blinks) → green and orange (5 blinks) → red and orange (5 blinks) → solid green
<u>For three buttons industrial printer series</u> Hold the FEED key and power on the switch. The ERROR LED will be on. Printer is now ready to use.
<u>For six or two buttons industrial printer series</u> Hold the PAUSE and FEED keys and power on the switch. "AUTO.BAS" will not be executed after printer initialization, and will now be ready for use. Alternatively, hold the PAUSE key and power on the switch. After sensor calibration, the "AUTO.BAS" will not be executed. Printer is now ready for use.

Syntax

1. Download a program file:

DOWNLOAD [n,] "FILENAME.BAS"

<u>Parameter</u>	<u>Description</u>
n	Specify memory used to save downloaded files. <i>N is ignored:</i> Download files to DRAM only. If you would like to save the files from DRAM to Flash memory before turning off power, issue the MOVE command to printer. <i>F:</i> Download files to main board flash memory. <i>E:</i> Download files to expansion memory module.
FILENAME.BAS	The filename resident in printer memory.

Note:

- ***Filenames are case sensitive.***
- ***File extensions must be ".BAS"***
- ***Filenames must be in 8.3 format.***
- ***It should use with EOP command.***
- ***If memory is not specified, all files will be downloaded to DRAM.***
- ***The priority of AUTO.BAS in each memory device:***
 - A. DRAM > FLASH > CARD (Ext. FLASH) if firmware is before V6.80EZ.***
 - B. DRAM > CARD (Ext. FLASH) > FLASH if firmware is after V6.80EZ (include).***
- ***No Battery is used to back up files in DRAM. Which will be lost in the event printer power is lost.***

2. Download a data file:

DOWNLOAD [n,] "FILENAME",DATA SIZE,DATA CONTENT...

<u>Parameter</u>	<u>Description</u>
n	Specify the memory location to save downloaded files. <i>N is ignored:</i> Download files to DRAM only. If you would like to save the files from DRAM to Flash memory before turning off power, issue the MOVE command to printer. <i>F:</i> Download files to main board flash memory. <i>E:</i> Download files to expansion memory module.
FILENAME	The name of data file that will remain resident in the printer memory (case sensitive).
DATA SIZE	The actual size in bytes of the data file (without header)
DATA CONTENT	The data which will be downloaded into printer.

Note:

- ***For text data files, CR (carriage return) 0x0D and LF (Line Feed) 0x0A is the separator of data.***
- ***If memory is not specified, all files will be downloaded to DRAM.***
- ***No Battery is used to back up files in DRAM. Which will be lost in the event printer power is lost.***
- ***When writing a download program, "DOWNLOAD" header must be placed in the beginning of file, and "EOP" must be placed at the end of program.***

- *To run the program, call the main filename without BAS extension or use RUN command to start the download program.*

Example

Sample code (The example program listed below will download to printer SDRAM.)

```
DOWNLOAD "EXAMPLE.BAS"  
SIZE 4,4  
GAP 0,0  
DIRECTION 1  
SET TEAR ON  
CLS  
TEXT 100,100, "3",0,1,1, "EXAMPLE PROGRAM"  
PRINT 1  
EOP
```

See Also

EOP, RUN, PUTBMP, PUTPCX, INPUT, FILES, ~!F

● EOP

Description

End of program. To declare the start and end of BASIC language commands used in a program, DOWNLOAD "FILENAME.BAS" must be added in the first line of the program, and "EOP" statement at the last line of program.

Syntax

EOP

Example

Sample code (The example program listed below will download to printer SDRAM.)

```
DOWNLOAD "DEMO.BAS"  
SIZE 4,4  
GAP 0,0  
DIRECTION 1  
SET TEAR ON  
CLS  
TEXT 100,100, "3",0,1,1, "DEMO PROGRAM"  
PRINT 1  
EOP
```

See Also

DOWNLOAD, INPUT, FILES, ~!F

● FILES

Description

This command prints out the total memory size, available memory size and files lists (or lists the files through RS-232) in the printer memory (both FLASH memory and DRAM).

Syntax

FILES

Example

Sample code	Result
<pre>FILES</pre>	<pre>----- DRAM FILE (0 FILES) ----- PHYSICAL 8192 KBYTES AVAILABLE 256 KBYTES ----- FLASH FILE (0 FILES) ----- PHYSICAL 4096 KBYTES AVAILABLE 2560 KBYTES -----</pre>

See Also

~!F, KILL

● KILL

Description

This command deletes a file in the printer memory. The wild card (*) will delete all files resident in specified DRAM or FLASH memory.

Syntax

KILL [n], "FILENAME"

<u>Parameter</u>	<u>Description</u>
n	Specify the memory location that files will be deleted. N is ignored: Kill files saved in DRAM. F: Kill files from main board flash memory. E: Kill files from expansion memory module.
FILENAME	The name of data file that will delete in the printer memory (case sensitive)

Note:

- **If optional parameter n is not specified, firmware will delete the file in DRAM.**
- **Syntax example**
 - KILL "FILENAME" : Delete the specify file in DRAM.**
 - KILL "*.PCX" : Delete all PCX files in DRAM.**
 - KILL "*" : Delete all files in DRAM.**
 - KILL F, "FILENAME" : Delete the specify file in FLASH.**
 - KILL E, "*.PCX" : Delete all PCX file in extension memory card.**
- **For TSPL printers, please send MOVE command to printer after sending KILL command.**
- **Please refer to [printer model list](#) for checking TSPL or TSPL2.**

Model	Support		
	KILL "*"	KILL "*" MOVE	KILL F, "*"
TSPL programming printer	V	V	
TSPL2 programming printer	V		V

Example

Users can use printer SELFTEST utility to list printer configurations and files saved in the printer memory, or use the FILES command to print the downloaded file list in printer. Follow the steps below to delete files in the printer memory via parallel port connection.

```
C:\>COPY CON LPT1<ENTER>
FILES<ENTER>
<CTRL><Z><ENTER>
C:\>COPY CON LPT1<ENTER>
KILL "DEMO.BAS " <ENTER>
<CTRL><Z><ENTER>
C:\>COPY CON LPT1<ENTER>
```

FILES<ENTER>
<CTRL><Z><ENTER>

Note: <ENTER> stands for PC keyboard "ENTER" key. <CTRL><Z> means to hold PC keyboard "CTRL" key then press the PC keyboard <Z> key

See Also

~!F, FILES

● MOVE

Description

This command moves downloaded files from DRAM to FLASH memory.

Syntax

MOVE

See Also

DOWNLOAD, EOP

● RUN

Description

This command executes a program resident in the printer memory. It is available for TSPL2 language printers only.

Syntax

RUN "FILENAME.BAS"

Note:

** This command can be replaced to filename that without typing ".BAS".*

** TDP-643 Plus, TTP-243, TTP-342, TTP-244ME, TTP-342M and TTP-248M series are not supported this feature*

Example

Sample code	Result
<pre>DOWNLOAD "DEMO.BAS" SIZE 4,4 GAP 0,0 DIRECTION 1 SET TEAR ON CLS TEXT 100,100, "3",0,1,1, "DEMO PROGRAM" PRINT 1 EOP RUN "DEMO.BAS"</pre>	<p>DEMO PROGRAM</p>
<pre>DOWNLOAD "DEMO.BAS" SIZE 4,4 GAP 0,0 DIRECTION 1 SET TEAR ON CLS TEXT 100,100, "3",0,1,1, "DEMO PROGRAM" PRINT 1 EOP DEMO</pre>	

See Also

DOWNLOAD, EOP

BASIC Commands and Functions

● ABS()

Description

This function returns the absolute value of an integer, floating point or variable.

Syntax

ABS (VARIABLE)

Example

Sample code	Result
<pre>DOWNLOAD "TEST.BAS" SIZE 4,4 GAP 0,0 DIRECTION 1 SET TEAR ON CLS A=ABS(-100) B=ABS(-50.98) C=-99.99 TEXT 100,100, "3",0,1,1,STR\$(A) TEXT 100,150, "3",0,1,1,STR\$(B) TEXT 100,200, "3",0,1,1,STR\$(ABSI) PRINT 1 EOP RUN "TEST.BAS"</pre>	<pre>100 50.98 99.99</pre>

See Also

DOWNLOAD, EOP

● ASC ()

Description

This function returns the ASCII code of the character.

Syntax

ASC (" A ")

Example

Sample code	Result
<pre>DOWNLOAD "TEST.BAS" SIZE 4,4 GAP 0,0 DIRECTION 1 SET TEAR ON CLS CODE1=ASC(" A ") TEXT 100,100, " 3 ",0,1,1,STR\$(CODE1) PRINT 1 EOP RUN "TEST.BAS"</pre>	<p>65</p>

See Also

DOWNLOAD, EOP, STR\$()

● CHR\$()

Description

This function returns the character with the specified ASCII code.

Syntax

CHR\$(n)

<u>Parameter</u>	<u>Description</u>
n	The ASCII code

Example

<u>Sample code</u>	<u>Result</u>
<pre>DOWNLOAD "TEST.BAS" SIZE 4,4 GAP 0,0 DIRECTION 1 SET TEAR ON CLS A=75 WORD\$=CHR\$(A) TEXT 100,100, "3",0,1,1,WORD\$ PRINT 1 EOP RUN "TEST.BAS"</pre>	K

See Also

DOWNLOAD, EOP, STR\$(), ASC\$()

● XOR\$()

Description

This command can encode the original data to a new data by logic XOR.

Syntax

XOR\$(data\$,password\$)

<u>Parameter</u>	<u>Description</u>
data\$	The original data needs to be encoded by password\$.
Password\$	This parameter will be used to create the new data.
Note: <i>This command has been supported since V6.38 EZ and later firmware.</i>	

Example

<u>Sample code</u>	<u>Result</u>
<pre>data\$="1234" password\$="ABCD" encoded\$=XOR\$(data\$,password\$) deconded\$=XOR\$(encoded\$,password\$) SIZE 4,0.5 GAP 0,0 CLS TEXT 10,10,"3",0,1,1, "Encoded data: "+encoded\$ TEXT 10,60, "3",0,1,1, "Decoded data: "+deconded\$ PRINT 1</pre>	<pre>Encoded data: pppp Decoded data: 1234</pre>

● END

Description

This command states the end of program.

Syntax

END

Example

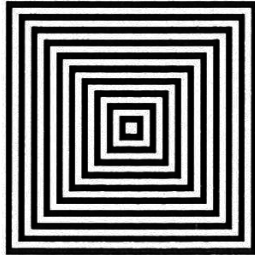
Sample code	Result
<pre>DOWNLOAD "DEMO.BAS" SIZE 4,2 GAP 0,0 DIRECTION 1 CLS TEXT 200,60, "4",0,1,1, "END COMMAND TEST" X=300 Y=200 X1=500 Y1=400 GOSUB DR_LINE PRINT 1 END :DR_LINE FOR I=1 TO 100 STEP 10 BOX X+I,Y+I,X1-I,Y1-I,5 NEXT RETURN EOP DEMO</pre>	<p>END COMMAND TEST</p> 

See Also

DOWNLOAD, EOP, GOSUB

● EOF()

Description

This function is used to detect an opened download file to see whether it has reached the end of file.

Syntax

EOF (File Handle)

<u>Parameter</u>	<u>Description</u>
File handle	Either 0 or 1
<u>Return value</u>	<u>Description</u>
None-zero	End of file
0	Not end of file

Example

Sample code

```
DOWNLOAD "DATA",16,COMPUTER
2000

DOWNLOAD "DEMO.BAS"
SIZE 3,3
GAP 0.0,0
DIRECTION 1
CLS
OPEN "DATA",0
SEEK 0,0
Y=110
TEXT 10,10, "3",0,1,1, "*****EOF TEST*****"
:A
Temp$=""
READ 0,ITEM$,P
TEXT 10,Y,"2",0,1,1,ITEM$+"$" +STR$(P)+"[EOF(0)=" +STR$(EOF(0))+"]"
BARCODE 10,Y+25,"39",40,1,0,2,4,"PRICE-"+STR$(P)
Y=Y+100
IF EOF(0)=0 THEN GOTO A
PRINT 1
EOP
DEMO
```

Result

*****EOF TEST*****

COMPUTER\$2000 [EOF (0) = 1]



PRICE-2000

See Also

DOWNLOAD, EOP, OPEN, READ, SEEK

● OPEN

Description

This command opens a downloaded file and establishes the file handle. Up to two file handles are supported, thus only up to two files can be opened simultaneously. The file to be opened should be downloaded prior to using this command. When opening a file, the firmware will search automatically to see if the file exists in the on board flash memory or extended memory card. ****Since V6.37 EZ, if the file doesn't exist, the printer will create this file in the onboard FLASH.***

Syntax

OPEN [memory ID,] "filename",file handle

<u>Parameter</u>	<u>Description</u>								
[memory ID]	Optional. Open the file in specific memory device. <i>*Since V6.68 EZ.</i>								
	<table border="1"> <thead> <tr> <th>ID</th> <th>Memory device</th> </tr> </thead> <tbody> <tr> <td>Omitted</td> <td>DRAM</td> </tr> <tr> <td>F</td> <td>FLASH</td> </tr> <tr> <td>E</td> <td>CARD</td> </tr> </tbody> </table>	ID	Memory device	Omitted	DRAM	F	FLASH	E	CARD
ID	Memory device								
Omitted	DRAM								
F	FLASH								
E	CARD								
filename	The file downloaded in the printer memory								
file handle	Either 0 or 1								

Example

<u>Sample code</u>	<u>Result</u>
<pre> DOWNLOAD "DATA.DAT",18,Open file in DRAM. DOWNLOAD F, "DATA.DAT",19,Open file in FLASH. DOWNLOAD "TEST.BAS" data1\$="" data2\$="" data3\$="" OPEN "DATA.DAT",0 READ 0,data1\$ CLOSE 0 OPEN F, "DATA.DAT",0 READ 0,data2\$ CLOSE 0 KILL F, "*" OPEN "NEW.DAT",0 SEEK 0,0 WRITE 0, "Auto create a new file in FLASH." SEEK 0,0 READ 0,data3\$ CLOSE 0 SIZE 4,1 GAP 0,0 CLS TEXT 10,10,"3",0,1,1,data1\$ TEXT 10,60,"3",0,1,1,data2\$ TEXT 10,110,"3",0,1,1,data3\$ PRINT 1 EOP TEST </pre>	<pre> Open file in DRAM. Open file in FLASH. Auto create a new file in FLASH. </pre>

See Also

DOWNLOAD, EOP, READ, WRITE, SEEK, CLOSE

● CLOSE

Description

Close the file handle which is open by command OPEN.

Syntax

CLOSE file handle

<u>Parameter</u>	<u>Description</u>
file handle	Either 0 or 1

Example

See the example in command OPEN.

● WRITE

Description

This command writes data to a downloaded data file. Two files can be open simultaneously, by virtue of printer support for two file handles.

Syntax

WRITE file handle,variables

<u>Parameter</u>	<u>Description</u>
file handle	0 or 1
variables	string, integer or float point variable

See Also

READ, DOWNLOAD, EOP, OPEN, EOF, LOF, SEEK, FREAD\$()

● READ

Description



This command reads data from downloaded data file.

Syntax

READ file handle,variables

<u>Parameter</u>	<u>Description</u>
file handle	0 or 1
variables	string, integer or float point variable

Example

<u>Sample code</u>	<u>Result</u>
<pre>DOWNLOAD "DATA1",20,COMPUTER 2000 12 DOWNLOAD "DATA2",16,Mouse 900 93 DOWNLOAD "DEMO.BAS" SIZE 3,1 GAP 0,0 DIRECTION 1 I=0 Y=100 OPEN "DATA1",0 OPEN "DATA2",1 SEEK 0,0 SEEK 1,0 :Start CLS TEXT 10,10,"3",0,1,1,"*****READ COMMAND TEST*****" TEXT 10,50,"3",0,1,1,"OPEN-READ DATA"+STR\$(I+1) ITEM\$="" READ I,ITEM\$,P,Q TEXT 10,Y,"2",0,1,1,ITEM\$+"\$" +STR\$(P) BARCODE 10,Y+25,"39",40,1,0,2,4,"PRICE*" +STR\$(Q)+ "=" "+STR\$(P*Q) Y=Y+100 PRINT 1 Y=100 IF I<=1 THEN IF EOF(I)=1 THEN I=I+1 GOTO Start ELSE GOTO Start ENDIF ELSE END ENDIF EOP DEMO</pre>	<pre>*****READ COMMAND TEST***** OPEN-READ DATA3 \$900  PRICE*93=83700 *****READ COMMAND TEST***** OPEN-READ DATA2 Mouse\$900  PRICE*93=83700 *****READ COMMAND TEST***** OPEN-READ DATA1 COMPUTER\$2000  PRICE*12=24000</pre>

See Also

DOWNLOAD, EOP, OPEN, EOF, LOF, SEEK, FREAD\$()

● SEEK

Description

This command shifts the specified file pointer to a certain position.

Syntax

SEEK file handle,offset

<u>Parameter</u>	<u>Description</u>
file handle	0 or 1
offset	the offset characters which are shifted to a new position

Example

<u>Sample code</u>	<u>Result</u>
<pre>DOWNLOAD "DATA",12,1234567890 DOWNLOAD "TEST.BAS" SIZE 4,1.5 GAP 0,0 DIRECTION 1 REFERENCE 0,0 CLS OPEN "DATA",0 SEEK 0,4 READ 0,Num\$ TEXT 100,10,"3",0,1,1,"SEEK COMMAND TEST" BAR 100,40,300,4 TEXT 100,60,"3",0,1,1,"SHIFT 4 CHARACTERS" TEXT 100,110,"3",0,1,1,Num\$ BAR 100,140,300,4 SEEK 0,0 READ 0,Num\$ TEXT 100,160,"3",0,1,1,"SHIFT 0 CHARACTERS" TEXT 100,210,"3",0,1,1,Num\$ PRINT 1 EOP TEST</pre>	<pre>SEEK COMMAND TEST SHIFT 4 CHARACTERS 567890 SHIFT 0 CHARACTERS 1234567890</pre>

See Also

DOWNLOAD, EOP, OPEN, READ, EOF, LOF, FREAD\$()

● LOF()

Description

This function returns the size of the specified file.

Syntax

LOF("FILENAME")

<u>Parameter</u>	<u>Description</u>
FILENAME	The file downloaded in the printer memory.

Example

<u>Sample code</u>	<u>Result</u>
<pre>DOWNLOAD "DATA1",10,1234567890 DOWNLOAD "DATA2",15,ABCDEFGHIJKLMNO DOWNLOAD "LofTest.BAS" SIZE 4,1.5 GAP 0,0 DIRECTION 1 CLS OPEN "DATA1",0 OPEN "DATA2",1 TEXT 10,20,"4",0,1,1,"LOF() FUNCTION TEST" J=LOF("DATA1") K=LOF("DATA2") TEXT 10,140,"3",0,1,1,"DATA1 IS: "+STR\$(J)+"Bytes" TEXT 10,200,"3",0,1,1,"DATA2 IS: "+STR\$(K)+"Bytes" PRINT 1 EOP LofTest</pre>	<pre>LOF() FUNCTION TEST DATA1 IS: 10 Bytes DATA2 IS: 15 Bytes</pre>

See Also

DOWNLOAD, EOP, OPEN, READ, EOF, SEEK, FREAD\$()

● LOC()

Description

This function returns the current read/write position within an open file.

Syntax

LOC(file handle)

<u>Parameter</u>	<u>Description</u>
file handle	0 or 1

Note:
This command has been supported since V6.86 EZ and later firmware.

Example

<u>Sample code</u>	<u>Result</u>
<pre>DOWNLOAD "DATA.DAT",30,12345678 12345678 12345678 DOWNLOAD "TEST.BAS" str1\$ = "" location = 0 OPEN "DATA.DAT",0 READ 0,str1\$ location = LOC(0) CLOSE 0 SIZE 4,1 GAP 0,0 CLS TEXT 10,10,"3",0,1,1,"str1\$: "+str1\$ TEXT 10,60,"3",0,1,1,"Location:"+STR\$(location) PRINT 1 EOP TEST</pre>	<pre>str1\$: 12345678 Location:10</pre>

● FREAD\$()

Description

This function reads a specified number of bytes of data from a file.

Syntax

FREAD\$(file handle,byte)

<u>Parameter</u>	<u>Description</u>
file handle	0 or 1
byte	Number of bytes to be read

Example

<u>Sample code</u>	<u>Result</u>
<pre>DOWNLOAD "DATA1",10,1234567890 DOWNLOAD "DATA2",15,ABCDEFGHIJKLMNO DOWNLOAD "OPEN2.BAS" SIZE 4,1 GAP 0,0 DIRECTION 1 CLS OPEN "DATA1",0 OPEN "DATA2",1 SEEK 0,0 SEEK 1,0 Y\$=FREAD\$(0,6) Z\$=FREAD\$(1,6) TEXT 10,100,"3",0,1,1,"FREAD\$(0,6) IS: " +Y\$ TEXT 10,150,"3",0,1,1,"FREAD\$(1,6) IS: " +Z\$ PRINT 1 EOP OPEN2</pre>	<pre>FREAD\$(0,6) IS: 123456 FREAD\$(1,6) IS: ABCDEF</pre>

See Also

DOWNLOAD, EOP, OPEN, READ, EOF, LOF(), SEEK

● PUT

Description

One byte is appended into file.

Syntax

```
PUT file handle,var1$[, var2$][,var3$][, ...]
```

```
PUT file handle,var1[, var2][,var3][, ...]
```

```
PUT file handle,var1$[, var2$][,var3$][, ...]
```

<u>Parameter</u>	<u>Description</u>
file handle	0 or 1
var\$	Data is a character
var	Data is ASCII value

Note:
This command has been supported since V6.91 EZ and later firmware.

Example

Sample code

```
DOWNLOAD "DATA1",10,1234567890
DOWNLOAD "TEST.BAS"
str1$ = ""
str2$ = ""
OPEN "DATA1",0
SEEK 0,0
READ 0,str1$
PUT 0,"a","B",49
SEEK 0,0
READ 0,str2$
CLOSE 0

SIZE 4,0.5
GAP 0,0
CLS
TEXT 10, 10,"3",0,1,1,"Original data in DATA1: "+str1$
TEXT 10, 60,"3",0,1,1,"New data in Data1: "+str2$
PRINT 1
EOP
TEST
```

Result

```
Original data in DATA1: 1234567890
New data in Data1: 1234567890aB1
```

See Also

DOWNLOAD, EOP, OPEN, READ, EOF, LOF(), SEEK, GET

● GET

Description

Get one byte from file.

Syntax

GET file handle,var1\$[,var2\$][,var3\$][, ...]

GET file handle,var1[,var2][,var3][, ...]

GET file handle,var1\$[,var2\$][,var3][, ...]

<u>Parameter</u>	<u>Description</u>
file handle	0 or 1
var\$	Get a character
var	Get ASCII value

Note:
This command has been supported since V6.91 EZ and later firmware.

Example

Sample code

```
DOWNLOAD "DATA1",10,1234567890
DOWNLOAD "TEST.BAS"
a$=""
b$=""
c=0
d$=""
e$=""
OPEN "DATA1",0
SEEK 0,0
GET 0,a$,b$,c
SEEK 0,0
FOR I=1 TO 5
GET 0,d$
e$=e$+d$
NEXT

SIZE 4,0.5
GAP 0,0
CLS
TEXT 10,10,"3",0,1,1,"The first 3 characters in DATA1: "+a$+b$+" (" +STR$(c)+")"
TEXT 10,60,"3",0,1,1,"The first 5 characters in DATA1: "+e$
PRINT 1
EOP
TEST
```

Result

```
The first 3 characters in DATA1: 12 (51)
The first 5 characters in DATA1: 12345
```

See Also

DOWNLOAD, EOP, OPEN, READ, EOF, LOF(), SEEK, PUT

● COPY

Description

Copy the existed file from CARD to FLASH.

Syntax

COPY [memory ID of source,] "filename of source",[memory ID of new file,] "new filename"

<u>Parameter</u>	<u>Description</u>								
memory ID of source	Optional. <table border="1"><thead><tr><th>ID</th><th>Memory device</th></tr></thead><tbody><tr><td>Omitted</td><td>DRAM</td></tr><tr><td>F</td><td>FLASH</td></tr><tr><td>E</td><td>CARD</td></tr></tbody></table>	ID	Memory device	Omitted	DRAM	F	FLASH	E	CARD
ID	Memory device								
Omitted	DRAM								
F	FLASH								
E	CARD								
source filename	The file in CARD which you want to copy to on board FLASH.								
Memory ID of new file	Optional. <table border="1"><thead><tr><th>ID</th><th>Memory device</th></tr></thead><tbody><tr><td>Omitted</td><td>DRAM</td></tr><tr><td>F</td><td>FLASH</td></tr></tbody></table>	ID	Memory device	Omitted	DRAM	F	FLASH		
ID	Memory device								
Omitted	DRAM								
F	FLASH								
new filename	The new filename you want to use in the on board FLASH.								

Note: This command has been supported since V6.78 EZ and later firmware.

Example

Sample Code

```
DOWNLOAD "DATA_D.DAT",105,We stand behind our products with one of the most comprehensive support
programs in the Auto-ID industry.
DOWNLOAD "TEST.BAS"
KILL F,"*"
COPY "DATA_D.DAT",F,"DATA_F.DAT"
OPEN "DATA_F.DAT",0
SEEK 0,0
data$=FREAD$(0,LOF("DATA_F.DAT"))
CLOSE 0
SIZE 4,0.5
GAP 0,0
CLS
BOX 10,10,800,100,2
BLOCK 15,15,790,90,"0",0,8,8,20,2,data$
PRINT 1
EOP
TEST
```

Result

203 dpi

We stand behind our products with one of the most comprehensive support programs in
the Auto-ID industry.

300 dpi

We stand behind our products with one of the most
comprehensive support programs in the Auto-ID industry.

See Also

DOWNLOAD, EOP, OPEN, FREAD\$(), EOF, LOF(), SEEK, CLOSE

● FOR...NEXT LOOP

Description

Loop is used to execute one or more lines of program repetitively. A loop counter value specifies the number of executions. Nested loops are allowed (up to 39 nested loops) in this printer. Jumping out in the middle of the FOR...NEXT loop is prohibited.

Syntax

```
FOR variable = start TO end STEP increment
    statement; start < end
[EXITFOR]
NEXT
```

Parameter	Description
variable	The variable name (up to 8 characters)
start	Integer or floating point numbers
end	Integer or floating point numbers
increment	Integer or floating point, positive or negative
EXITFOR	Exit for loop

Example

Sample code	Result
<pre>DOWNLOAD "TEST.BAS" SIZE 4,2.5 GAP 0,0 CLS FOR I=1 TO 10 STEP 1 TEXT 100,10+30*(I-1),"3",0,1,1,STR\$(I) NEXT FOR I=1 TO 1000 STEP 100 TEXT 200,10+((I-1)/10)*3,"3",0,1,1,STR\$(I) NEXT FOR I=110 TO 10 STEP -10 TEXT 300,10+(ABS(I-110))*3,"3",0,1,1,STR\$(I) NEXT FOR I=1 TO 5 STEP 0.5 IF I-INT(I)=0 THEN Y=10+60*(I-1) ELSE Y=Y+30 TEXT 400,Y,"3",0,1,1,STR\$(I) NEXT PRINT 1 EOP TEST</pre>	<pre> 1 1 110 1 2 101 100 1.5 3 201 90 2 4 301 80 2.5 5 401 70 3 6 501 60 3.5 7 601 50 4 8 701 40 4.5 9 801 30 5 10 901 20 10 901 20</pre>

See Also

DOWNLOAD, EOP

● WHILE...WEND

Description

Executes a series of statements as long as a given condition is True. Nested loops are allowed (up to 39 nested loops) in this printer.

Syntax

```
WHILE condition
[statement]
WEND
```

Parameter	Description
condition	Available relational operator: <, >, =, <=, >=, <> <i>*Relational operator <>, not equal, was supported since V5.10 EZ.</i>
Statement	One or more statements executed while condition is True.
Note: <i>This command has been supported since V5.10 EZ and later firmware.</i>	

Example

Sample Code	Result
<pre>DOWNLOAD "TEST.BAS" I=0 TOTAL=0 WHILE I<100 I=I+1 TOTAL=TOTAL+I WEND SIZE 4,0.5 GAP 0,0 CLS TEXT 10,10, "3",0,1,1, "1+2+3+ ... + 100 = " +STR\$(TOTAL) PRINT 1 EOP TEST</pre>	<pre>1+2+3+ ... + 100 = 5050</pre>
<pre>DOWNLOAD "TEST.BAS" data\$="" SIZE 4,0.3 GAP 0,0 DIRECTION 1 INPUT "Data: ",data\$ WHILE data\$ <> "Quit" CLS TEXT 10,10, "3",0,1,1, "Data: "+data\$ PRINT 1 INPUT "Data: ",data\$ WEND CLS TEXT 10,10, "3",0,1,1, "Quit BAS" PRINT 1 EOP TEST 12345 67890 quit Quit</pre>	<pre>Quit BAS Data: quit Data: 67890 Data: 12345</pre>

● DO...LOOP

Description

Repeats a block of statement while a condition is True.

Syntax

```
DO
    [statement]
    [EXITDO]
    [statement]
LOOP
```

```
DO WHILE condition
    [statement]
    [EXITDO]
    [statement]
LOOP
```

```
DO UNTIL condition
    [statement]
    [EXITDO]
    [statement]
LOOP
```

```
DO
    [statement]
    [EXITDO]
    [statement]
LOOP WHILE condition
```

```
DO
    [statement]
    [EXITDO]
    [statement]
LOOP UNTIL condition
```

<u>Parameter</u>	<u>Description</u>
condition	Available relational operator: <, >, =, <=, >=, <> *Relational operator <>, not equal, was supported since V5.10 EZ.
Statement	One or more statements executed while condition is True.
EXITDO	Exit loop

Note:
This command has been supported since V5.10 EZ and later firmware.

Example

Sample Code	Result
<pre> DOWNLOAD "TEST.BAS" I=0 TOTAL=0 DO I=I+1 TOTAL=TOTAL+I IF I=100 THEN EXITDO LOOP SIZE 4,0.5 GAP 0,0 CLS TEXT 10,10, "3",0,1,1, "1+2+3+ ... + 100 = " + STR\$(TOTAL) PRINT 1 EOP TEST </pre>	$1+2+3+ \dots + 100 = 5050$
<pre> DOWNLOAD "TEST.BAS" I=0 TOTAL=0 DO WHILE I<=100 TOTAL=TOTAL+I I=I+1 LOOP SIZE 4,0.5 GAP 0,0 CLS TEXT 10,10, "3",0,1,1, "1+2+3+ ... + 100 = " + STR\$(TOTAL) PRINT 1 EOP TEST </pre>	$1+2+3+ \dots + 100 = 5050$
<pre> DOWNLOAD "TEST.BAS" I=0 TOTAL=0 DO UNTIL I>100 TOTAL=TOTAL+I I=I+1 LOOP SIZE 4,0.5 GAP 0,0 CLS TEXT 10,10, "3",0,1,1, "1+2+3+ ... + 100 = " + STR\$(TOTAL) PRINT 1 EOP TEST </pre>	$1+2+3+ \dots + 100 = 5050$

<pre> DOWNLOAD "TEST.BAS" I=0 TOTAL=0 DO TOTAL=TOTAL+I I=I+1 LOOP WHILE I<101 SIZE 4,0.5 GAP 0,0 CLS TEXT 10,10, "3",0,1,1, "1+2+3+ ... + 100 =" + STR\$(TOTAL) PRINT 1 EOP TEST </pre>	$1+2+3+ \dots + 100 = 5050$
<pre> DOWNLOAD "TEST.BAS" I=0 TOTAL = 0 DO TOTAL = TOTAL + I I=I+1 LOOP UNTIL I>100 SIZE 4,0.5 GAP 0,0 CLS TEXT 10,10, "3",0,1,1, "1+2+3+ ... + 100 = " + STR\$(TOTAL) PRINT 1 EOP TEST </pre>	$1+2+3+ \dots + 100 = 5050$

● IF...THEN...ELSE...ENDIF LOOP

Description

Use IF...THEN block to execute one or more statements conditionally. Either a single-line syntax or multiple-line “block” syntax can be used.

Note: TDP-643 Plus, TTP-243, TTP-342, TTP-244ME and TTP-342M series are not supported multiple-line form.

Syntax

IF condition THEN statement

Note the single-line form of IF ...THEN does not use an ENDIF statement.

Or

```
IF condition THEN                (TSPL2 printers only)
    Statements
ENDIF
```

Or

```
IF condition THEN                (TSPL2 printers only)
    Statements
ELSE
    Statements
ENDIF
```

Or

```
IF condition 1 THEN              (TSPL2 printers only)
    Statement block 1
ELSEIF condition 2 THEN
    Statement block 2
    . . .
ELSEIF condition n THEN
    Statement block n
ENDIF
```

***The syntax of IF...THEN...ELSE requires that the command be typed in one single line in less than 255 characters.**

<u>Parameter</u>	<u>Description</u>
condition	Available relational operator: <, >, =, <=, >=, <> *Relational operator <>, not equal, was supported since V5.10 EZ.
Statement	Only one statement is available in

Example

Sample Code	Result
<pre> DOWNLOAD "DEMO.BAS" SIZE 4,4 GAP 0,0 DIRECTION 1 CLS A=0 B=0 C=0 D=0 E=0 F=0 G=0 H=0 J=0 K=0 L=0 FOR I=1 TO 100 IF I-INT(I/1)*1=0 THEN A=A+I IF I-INT(I/2)*2=1 THEN B=B+I ELSE C=C+I IF I-INT(I/3)*3=0 THEN D=D+I ENDIF IF I-INT(I/5)*5=0 THEN E=E+I ELSE F=F+I ENDIF IF I-INT(I/7)*7=0 THEN G=G+I ELSEIF I-INT(I/17)*17=0 THEN H=H+I ELSEIF I-INT(I/27)*27=0 THEN J=J+I ELSEIF I-INT(I/37)*37=0 THEN K=K+I ELSE L=L+I ENDIF NEXT TEXT 100,110,"3",0,1,1,"(1) 1+2+3+...+100="+STR\$(A) TEXT 100,160,"3",0,1,1,"(2) 1+3+5+...+99="+STR\$(B) TEXT 100,210,"3",0,1,1,"(3) 2+4+6+...+100="+STR\$(C) TEXT 100,260,"3",0,1,1,"(4) 3+6+9+...+99="+STR\$(D) TEXT 100,310,"3",0,1,1,"(5) 5+10+15+...+100="+STR\$(E) TEXT 100,360,"3",0,1,1," (1)-(5)= "+STR\$(F) TEXT 100,410,"3",0,1,1,"(6) 7+14+21+...+98="+STR\$(G) TEXT 100,460,"3",0,1,1,"(7) 17+34+51+...+85=" +STR\$(H) TEXT 100,510,"3",0,1,1,"(8) 27+54+...+81="+STR\$(J) TEXT 100,560,"3",0,1,1,"(9) 37+74="+STR\$(K) TEXT 100,610,"3",0,1,1," (1)-(6)-(7)-(8)-(9)="+STR\$(L) PRINT 1,1 </pre>	<pre> (1) 1+2+3+...+100=5050 (2) 1+3+5+...+99=2500 (3) 2+4+6+...+100=2550 (4) 3+6+9+...+99=1683 (5) 5+10+15+...+100=1050 (1)-(5)=4000 (6) 7+14+21+...+98=735 (7) 17+34+51+...+85=255 (8) 27+54+...+81=162 (9) 37+74=111 (1)-(6)-(7)-(8)-(9)=3787 </pre>

EOP	
<pre> DOWNLOAD F, "TEST.BAS" SIZE 4,1 GAP 0,0 DIRECTION 1 CLS A=85 B=10 :START IF A<100 THEN GOTO L1 ELSE GOTO L2 :L1 CLS TEXT 100,10,"3",0,1,1,STR\$(A) + " IS SMALLER THEN 100" PRINT 1 A=A+B GOTO START ENDIF :L2 CLS TEXT 100,10,"3",0,1,1,STR\$(A) + "IS LAGER THEN 100" PRINT 1 EOP TEST </pre>	<pre> 105 IS LAGER THEN 100 95 IS SMALLER THEN 100 85 IS SMALLER THEN 100 </pre>

Note:

If the result of the expression is nonzero, the statement following THEN will be executed. If the result of the expression is zero, and the statement following the ELSE is present, it will be executed. Otherwise the next line of statement is executed.

If there are block of statements in IF...THEN ...ELSE, ENDIF must be used at the end of the IF...THEN ...ELSE statement.

Limitations:

The total numbers of nested IF ...THEN ...ELSE statement in a program cannot exceed 40.

The total numbers of nested IF ...THEN ...ELSE, FOR...NEXT, GOSUB RETURN in a program cannot exceed 40 loops.

See Also

DOWNLOAD, EOP

● GOSUB...RETURN

Description

This command will branch to a subroutine, executing statements until "RETURN" is reached.

Syntax

```
GOSUB LABEL  
    statement
```

```
END
```

```
:LABEL  
    statement
```

```
RETURN
```

<u>Parameter</u>	<u>Description</u>
LABEL	Beginning of the subroutine. The maximum length of the label is 8 characters.

Example

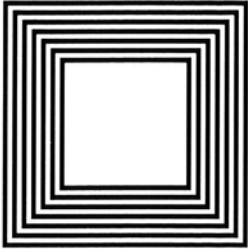
<u>Sample code</u>	<u>Result</u>
<pre>DOWNLOAD "GOSUB1.BAS" SIZE 4,3 GAP 0,0 DIRECTION 1 CLS TEXT 10,10,"3",0,1,1,"GOSUB & RETURN COMMAND TEST" GOSUB DR_BOX PRINT 1 END :DR_BOX FOR I=21 TO 81 STEP 10 BOX 80+I,80+I,80+300-I,80+300-I,5 NEXT RETURN EOP GOSUB1</pre>	<p>GOSUB & RETURN COMMAND TEST</p> 

See Also

DOWNLOAD, EOP, END, GOTO

● GOTO

Description

This command is used to branch to a specified label. The label cannot exceed 8 characters in length.

Syntax

GOTO LABEL

:LABEL

<u>Parameter</u>	<u>Description</u>
LABEL	Beginning of the point. The maximum length of the label is 8 characters.

Example

<u>Sample code</u>	<u>Result</u>
<pre>DOWNLOAD "GOTO1.BAS" SIZE 4,3 GAP 0,0 DIRECTION 1 CLS A=0 TOTAL=0 :START IF A<100 THEN GOTO SUM ELSE GOTO PRTOUT ENDIF :SUM A=A+1 TOTAL=TOTAL+A GOTO START :PRTOUT B\$="THE SUMMATION OF 1..100 IS "+STR\$(TOTAL) TEXT 10,100, "3",0,1,1,B\$ PRINT 1 END EOP</pre>	<pre>THE SUMMATION OF 1..100 IS 5050</pre>

See Also

DOWNLOAD, EOP, END, GOSUB...RETURN

● INP\$ ()

Description

One byte is received from communication port.

Syntax

INP\$(n)

<u>Parameter</u>	<u>Description</u>
N	1 : com1 port in printer

Example

Sample code

```
DOWNLOAD "TEST.BAS"

T$=""
FOR I=1 TO 5
T$=T$+INP$(1)
NEXT

SIZE 4,0.5
GAP 0,0
CLS
TEXT 10,10, "3",0,1,1, "The received data is: "+T$
PRINT 1
EOP
TEST
12345
```

Result

The received data is: 12345

See Also

INP()

● INP()

Description

One byte (ASCII value) is received from communication port.

Syntax

INP(n)

<u>Parameter</u>	<u>Description</u>
n	1 : com1 port in printer

Note:
This command has been supported since V6.91 EZ and later firmware.

Example

<p>Sample code</p> <pre>DOWNLOAD "TEST.BAS" 146sci=0 str\$="" FOR I=1 TO 5 146sci=INP(1) str\$=str\$+" " +STR\$(146sci) OUT 146sci NEXT SIZE 4,0.5 GAP 0,0 CLS TEXT 10,10, "3",0,1,1, "The received data is: "+str\$ PRINT 1 EOP TEST 12345</pre>
<p>Result</p> <p>The received data is: 49 50 51 52 53</p>

See Also

INP\$()

● LOB()

Description

This function returns the size of data in receiving buffer.

Syntax

LOB ()

Note:

This command has been supported since V6.78 EZ and later firmware.

Example

Sample Code

```
DOWNLOAD "TEST.BAS"
```

```
DATA$=""
```

```
WHILE LOB(<>0
```

```
DATA$=DATA$+INP$(1)
```

```
WEND
```

```
SIZE 4,0.5
```

```
GAP 0,0
```

```
CLS
```

```
BOX 10,10,800,100,2
```

```
BLOCK 15,15,790,90, "0",0,8,8,DATA$
```

```
PRINT 1
```

```
EOP
```

```
TEST
```

```
We stand behind our products with one of the most comprehensive support programs in the Auto-ID industry.
```

Result

203 dpi:

```
We stand behind our products with one of the most comprehensive support programs in the Auto-ID industry.
```

300 dpi:

```
We stand behind our products with one of the most comprehensive support programs in the Auto-ID industry.
```

See Also

INP\$(), WHILE ... WEND

● INPUT

Description

This command receives data through specific port. This command is used with portable keyboard KP-200.

Syntax

INPUT ["Prompt string", number of digits], variables

The comma also can be replaced by semicolon, such as:

INPUT ["Prompt string"; number of digits]; variables

<u>Parameter</u>	<u>Description</u>
Prompt string	The prompt string is shown on keyboard LCD screen. The maximum length of prompt string is 20 characters
Number of digits	Maximum number of characters is 255
Variables	The variable to receive input data

Example

<u>Sample code</u>	<u>Result</u>
<pre>DOWNLOAD "TEXT.BAS" SIZE 4,3 GAP 0,0 DIRECTION 1 :START INPUT "CODE 39 : ",C39\$ INPUT "EAN 13: ",12,E13\$ CLS TEXT 20,50, "3",0,1,1, "INPUT and KP-200 Test" BARCODE 20,100, "39",48,1,0,2,5,C39\$ BARCODE 20,200, "EAN13",48,1,0,4,4,E13\$ PRINT 1 GOTO START EOP TEXT 123456 123456789012</pre>	<pre>INPUT and KP-200 Test 123456 1234567890128</pre> 

See Also

DOWNLOAD, EOP, END, GOTO

● PREINPUT

Description

This command can define the start character for command INPUT.

Syntax

PREINPUT var\$
PREINPUT CHR\$(n)

<u>Parameter</u>	<u>Description</u>
var\$	The specific character or string in front of data.
N	n = 1 ~ 255

Note:
This command has been supported since V6.81 EZ and later firmware.

Example

PREINPUT "<"
PREINPUT CHR\$(2)

See also

POSTINPUT, INPUT, SET FILTER

● POSTINPUT

Description

This command can define the end character for command INPUT.

Syntax

```
POSTINPUT var$  
POSTINPUT CHR$(n)
```

<u>Parameter</u>	<u>Description</u>
var\$	The specific character or string in end of data.
N	n = 1 ~ 255

Note:
This command has been supported since V6.81 EZ and later firmware.

Example

```
POSTINPUT ">"  
POSTINPUT CHR$(3)
```

See also

PREINPUT, INPUT, SET FILTER

● SET FILTER ON/OFF

Description

This command is using to enable/disable commands PREINPUT and POSTINPUT.

Syntax

SET FILTER ON/OFF

<u>Parameter</u>	<u>Description</u>
ON	Enable PREINPUT and POSTINPUT
OFF	Disable PREINPUT and POSTINPUT

Note:
This command has been supported since V6.81 EZ and later firmware.

Example

<u>Sample Code</u>	<u>Result</u>
<pre>DOWNLOAD "TEST.BAS" PREINPUT "<=" POSTINPUT "=>" SET FILTER ON START: INPUT "DATA",data1\$ SIZE 4,0.25 GAP 0,0 DIRECTION 1 CLS TEXT 10,10, "3",0,1,1, "DATA = "+data1\$ PRINT 1 GOTO START EOP TEST <=1234=><=5678=><=9012=></pre>	<pre>DATA = 9012 DATA = 5678 DATA = 1234</pre>

See also

PREINPUT, POSTINPUT, INPUT

● REM

Description

Comment. Prefix is "REM", which will be ignored by the printer.

Syntax

REM

Example

Sample code

```
REM *****  
REM This is a demonstration program*  
REM *****  
DOWNLOAD "REMARK.BAS"  
SIZE 4,3  
GAP 0,0  
DIRECTION 1  
CLS  
TEXT 50,50, "3",0,1,1, "REMARK DEMO PROGRAM"  
REM TEXT 50,100, "3",0,1,1, "REMARK DEMO PROGRAM"  
PRINT 1,1  
EOP  
REMARK
```

Result

REMARK DEMO PROGRAM

See Also

DOWNLOAD, EOP, END

● OUT

Description

This command returns data through the specific port.

Syntax

OUT [port] "prompt",variable

OUT [port] "prompt";variable

Parameter	Description
port	Optional. Specified the port for returning data/string. Default is returning the data/string from the port which is sending data to printer. COM: Returning data/string from COM port. USB: Returning data/string from USB port. NET: Returning data/string from LAN port.
Prompt	Prompt string.
Variable	The output message.
,	The "prompt" and "variable" are separated by <0x0D><0x0A>.
;	The "variable" comes behind "prompt" directly.
Note: <i>This command has been supported since V6.93 EZ and later firmware.</i>	

Example

Sample Code

OUT USB "USB: "; "This is returning data from USB. "

OUT COM "COM"; "This is returning data from COM. "

OUT NET "NET: "; "This is returning data from LAN. "

Result

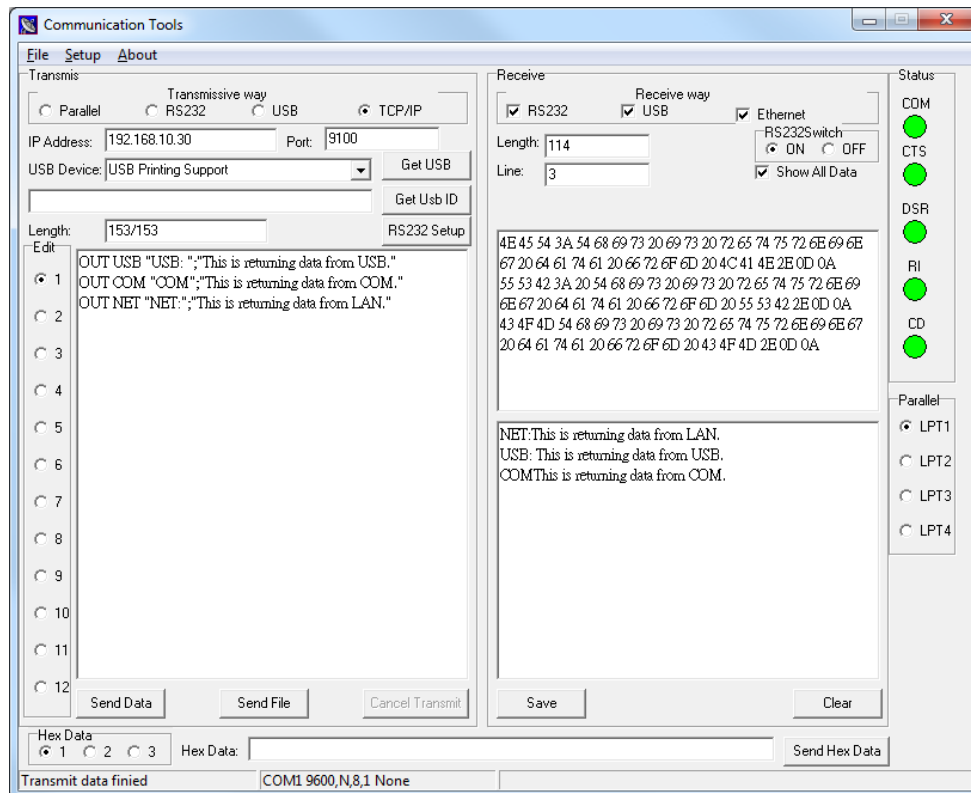

● OUTR

Description

This command sends data through RS-232 port only.

Syntax

OUTR "prompt",variable

OUTR "prompt";variable

<u>Parameter</u>	<u>Description</u>
prompt	Prompt string.
Variable	The output message.
,	The "prompt" and "variable" are separated by <0x0D><0x0A>.
;	The "variable" comes behinds "prompt" directly.

Note:
This command has been supported since V6.68 EZ and later firmware.

Example

Sample Code

OUTR "COM: ", " This is returning data from RS-232 only."

Result

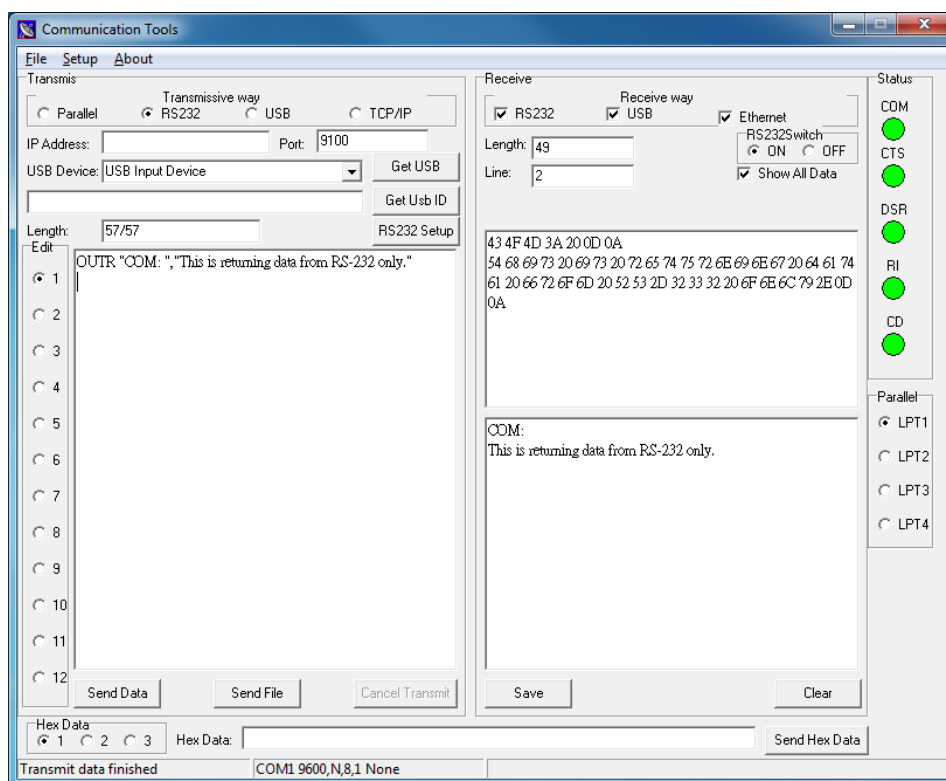

GETKEY()

Description

This command is used to get the status of the PAUSE and FEED keys. This command waits until either key is pressed, whereupon 0 is returned if PAUSE key is pressed and 1 is returned if FEED key is pressed.

Syntax

GETKEY()

PAUSE	FEED
0	1

Note: Desktop printers do not have the PAUSE key except TTP-243/244 series printers.

Example

Sample code

```
DOWNLOAD "DEMO4.BAS"  
SIZE 4,3  
GAP 0,0  
CLS  
:START  
A=GETKEY()  
IF A=0 THEN GOTO PAUSEB  
IF A=1 THEN GOTO FEEDB  
:PAUSEB  
CLS  
TEXT 50,10, "4",0,1,1, "PAUSE key is pressed !"  
PRINT 1  
GOTO START  
:FEEDB  
CLS  
TEXT 50,10, "4",0,1,1, "FEED key is pressed !"  
PRINT 1  
EOP
```

See Also

DOWNLOAD, EOP, END, GOTO

● INT()

Description

This function truncates a floating point number.

Syntax

INT (n)

<u>Parameter</u>	<u>Description</u>
n	Positive or negative integer, floating point number or mathematical expression

Example

<u>Sample code</u>	<u>Result</u>
<pre>DOWNLOAD "DEMO.BAS" SIZE 4,1 GAP 0,0 DIRECTION 1 INPUT "Number: ",Num CLS REM **** To round up or down**** N=INT(Num+0.5) IF N>Num THEN TEXT 50,100, "3",0,1,1, "To round up= " +STR\$(N) ELSE TEXT 50,100, "3",0,1,1, "To round down= " +STR\$(N) ENDIF PRINT 1 EOP 56.2</pre>	<p>To round down= 56</p>

See Also

DOWNLOAD, EOP, END, ABS(), ASC(), STR\$()

● LEFT\$()

Description

This function returns the specified number of characters down from the initial character of a string.

Syntax

LEFT\$(X\$, n)

<u>Parameter</u>	<u>Description</u>
X\$	The string to be processed
n	The number of characters to be returned

Example

<u>Sample code</u>	<u>Result</u>
<pre>DOWNLOAD "TEST.BAS" SIZE 4,1 GAP 0,0 DIRECTION 1 A\$="BARCODE PRINTER DEMO PRINTING" C\$=LEFT\$(A\$,10) CLS TEXT 10,10,"3",0,1,1,A\$ TEXT 10,100,"3",0,1,1, "10 LEFT 10 CHARS: " +C\$ PRINT 1 EOP TEST</pre>	<pre>BARCODE PRINTER DEMO PRINTING 10 LEFT 10 CHARS: BARCODE PR</pre>

See Also

DOWNLOAD, EOP, END, RIGHT\$(), MID\$(), LEN(), STR\$()

● LEN()

Description

This function returns the length of a string.

Syntax

LEN (string)

<u>Parameter</u>	<u>Description</u>
string	The string whose length is to be measured.

Example

<u>Sample Code</u>	<u>Result</u>
<pre>DOWNLOAD "DEMO.BAS" SIZE 4,1 GAP 0,0 DIRECTION 1 A\$="ABCDEFGHIJKLMNPOQRSTUVWXYZ" B=LEN(A\$) CLS TEXT 10,10, "3",0,1,1,A\$ TEXT 10,50, "3",0,1,1,"STRING LENGTH=" +STR\$(B) PRINT 1 EOP DEMO</pre>	<pre>ABCDEFGHIJKLMNPOQRSTUVWXYZ STRING LENGTH=26</pre>

See Also

DOWNLOAD, EOP, END, LEFT\$(), LEN(), RIGHT\$(), MID\$(), STR\$(), VAL()

● MID\$()

Description

This function retrieves the specified number of characters down from the *m*th character of a string.

Syntax

MID\$(string,m,n)

<u>Parameter</u>	<u>Description</u>
string	The string to be processed
m	The beginning of m th characters in the string 1 <= m <= string length
n	The number of characters to return

Example

<u>Sample code</u>	<u>Result</u>
<pre>DOWNLOAD "DEMO.BAS" SIZE 4,1 GAP 0,0 DIRECTION 1 A\$="ABCDEFGHIJKLMNPOQRSTUVWXYZ" E\$=MID\$(A\$,11,10) CLS TEXT 10,10, "3",0,1,1,A\$ TEXT 10,200, "3",0,1,1,"10 MIDDLE CHARS: "+E\$ PRINT 1 EOP DEMO</pre>	<pre>ABCDEFGHIJKLMNPOQRSTUVWXYZ 10 MIDDLE CHARS: KLMNOPQRST</pre>

See Also

DOWNLOAD, EOP, END, LEFT\$(), LEN(), RIGHT\$(), STR\$(), VAL()

● RIGHT\$()

Description

This function returns a specified number of characters up from the end of a string.

Syntax

RIGHT\$(X\$,n)

<u>Parameter</u>	<u>Description</u>
X\$	The string to be processed
n	The number of characters to be returned from the right side (end) of the string

Example

<u>Sample code</u>	<u>Result</u>
<pre>DOWNLOAD "DEMO.BAS" SIZE 4,1 GAP 0,0 DIRECTION 1 A\$="ABCDEFGHIJKLMNPOQRSTUVWXYZ" D\$=RIGHT\$(A\$,10) CLS TEXT 10,10,"3",0,1,1,A\$ TEXT 10,150,"3",0,1,1, "10 RIGHT CHARS: "+D\$ PRINT 1 EOP DEMO</pre>	<pre>ABCDEFGHIJKLMNPOQRSTUVWXYZ 10 RIGHT CHARS: QRSTUVWXYZ</pre>

See Also

DOWNLOAD, EOP, END, LEFT\$(), LEN(), MID\$(), STR\$(), VAL()

● STR\$()

Description

This function converts a specified value or expression into corresponding string of characters.

Syntax

STR\$(n)

<u>Parameter</u>	<u>Description</u>
n	An integer, floating point number or mathematical expression

Example

<u>Sample code</u>	<u>Result</u>
<pre>DOWNLOAD "DEMO.BAS" SIZE 4,1 GAP 0,0 DIRECTION 1 A\$="ABCDEFGHJKLMNOPQRSTUVWXYZ" F=100 G=500 H\$=STR\$(F+G) CLS TEXT 10,10, "3",0,1,1,A\$ TEXT 10,60, "3",0,1,1, "F=" +STR\$(F) TEXT 10,110, "3",0,1,1, "G=" +STR\$(G) TEXT 10,160, "3",0,1,1, "F+G=" +H\$ PRINT 1 EOP DEMO</pre>	<pre>ABCDEFGHI JKLMNOPQRSTUVWXYZ F=100 G=500 F+G=600</pre>

See Also

DOWNLOAD, EOP, END, LEFT\$(), LEN(), RIGHT\$(), MID\$(), VAL()

● STRCOMP()

Description

Returns -1, 0, or 1, based on the result of a string comparison.

Syntax

STRCOMP(str1\$,str2\$[,comp])

<u>Parameter</u>	<u>Description</u>
str1\$	Required. Any valid string expression.
Str2\$	Required. Any valid string expression.
Comp	Optional. Specifies the type of string comparison. 0: Binary comparison. Default. 1: Textual comparison. The comparison is case-insensitive .

Condition	Return value
str1\$ sorts ahead of str2\$	-1
str1\$ is equal to str2\$	0
str1\$ sorts after str2\$	1

Note:
This command has been supported since V6.81 EZ and later firmware.

Example

Sample Code

```
DOWNLOAD "TEST.BAS"  
STR1$ = "ABCD"  
STR2$ = "abcd"  
  
result1 = STRCOMP(STR1$,STR2$)  
result2 = STRCOMP(STR1$,STR2$,1)  
result3 = STRCOMP(STR2$,STR1$)  
  
SIZE 4,1  
GAP 0,0  
DIRECTION 1  
CLS  
TEXT 100,10,"3",0,1,1,STR$(result1)+": \[" +STR1$+"\[" sorts ahead of \[" +STR2$+" \["  
TEXT 100,60,"3",0,1,1," " +STR$(result2)+": \[" +STR1$+"\[" is equal to \[" +STR2$+" \["  
TEXT 100,110,"3",0,1,1," " +STR$(result3)+": \[" +STR2$+" \[" sorts after \[" +STR1$+" \["  
PRINT 1  
EOP  
TEST
```

Result

```
-1: "ABCD" sorts ahead of "abcd"  
0: "ABCD" is equal to "abcd"  
1: "abcd" sorts after "ABCD"
```

See Also

INSTR()

● INSTR ()

Description

Returns an integer specifying the start position of the first occurrence of one string within another.

Syntax

INSTR ([start,]str1\$,str2\$)

<u>Parameter</u>	<u>Description</u>
start	Optional. Numeric expression that sets the starting position for each search. If omitted, search begins at the first character position. The start index is 1 – based.
Str1\$	Required. String expression being searched.
Str2\$	Required. String expression sought.

Note:
This command has been supported since V6.59 EZ and later firmware.

Example

Sample code

```
DOWNLOAD "DEMO.BAS"
string$="ABC123ABC123"
searchfor$="123"
starpos=8

temp1=INSTR(string$,searchfor$)
temp2=INSTR(starpos,string$,searchfor$)

str1$=searchfor$+"in "+string$+"is "+STR$(temp1)
str2$=searchfor$+"in "+string$+"after"+STR$(starpos)+ " is "+STR$(temp2)

SIZE 4,1
GAP 0,0
DIRECTION 1
CLS
TEXT 10,10, "3",0,1,1,str1$
TEXT 10,60, "3",0,1,1,str2$
PRINT 1
EOP
DEMO
```

Result

```
123 in ABC123ABC123 is 4
123 in ABC123ABC123 after 8 is 10
```

See Also

STRCOMP()

● TRIM\$()

Description

Removes both leading and trailing blank spaces or specific characters from a string.

Syntax

TRIM\$(str\$,list\$)

<u>Parameter</u>	<u>Description</u>
str\$	The string that will be trimmed.
List\$	Optional. The specific characters in list\$ will be removed.

Note:
This command has been supported since V6.59 EZ and later firmware.

Example

<u>Sample Code</u>	
<pre>DOWNLOAD "DEMO.BAS" data1\$="1234567" data2\$="a1234567a" data3\$="[<12345>]" SIZE 4,1.5 GAP 0,0 DIRECTION 1 CLS TEXT 50,020,"3",0,1,1,"LTRIM\$(\" +data1\$+\" \") = " +LTRIM\$(data1\$) TEXT 50,050,"3",0,1,1,"TRIM\$(\" +data1\$+\" \") = " +TRIM\$(data1\$) TEXT 50,080,"3",0,1,1,"RTRIM\$(\" +data1\$+\" \") = " +RTRIM\$(data1\$) TEXT 50,110,"3",0,1,1,"LTRIM\$(\" +data2\$+ \"\", \")a\") = " +LTRIM\$(data2\$, "a") TEXT 50,140,"3",0,1,1,"TRIM\$(\" +data2\$+ \"\", \")a\") = " +TRIM\$(data2\$, "a") TEXT 50,170,"3",0,1,1,"RTRIM\$(\" +data2\$+ \"\", \")a\") = " +RTRIM\$(data2\$, "a") TEXT 50,200,"3",0,1,1,"LTRIM\$(\" +data3\$+ \"\", \") [< > \") = " +LTRIM\$(data3\$, "[<>]") TEXT 50,230,"3",0,1,1,"TRIM\$(\" +data3\$+ \"\", \") [< > \") = " +TRIM\$(data3\$, "[<>]") TEXT 50,260,"3",0,1,1,"RTRIM\$(\" +data3\$+ \"\", \") [< > \") = " +RTRIM\$(data3\$, "[<>]") PRINT 1 EOP DEMO</pre>	
<u>Result</u>	
<pre>LTRIM\$(" 1234567 ") = 1234567 TRIM\$(" 1234567 ") = 1234567 RTRIM\$(" 1234567 ") = 1234567 LTRIM\$("a1234567a", "a") = 1234567a TRIM\$("a1234567a", "a") = 1234567 RTRIM\$("a1234567a", "a") = a1234567 LTRIM\$("[<12345>", "[<>]") = 12345> TRIM\$("[<12345>", "[<>]") = 12345 RTRIM\$("[<12345>", "[<>]") = [<12345</pre>	

See Also

LTRIM\$(), RTRIM\$()

● LTRIM\$()

Description

Removes leading blank space from a string.

Syntax

LTRIM\$(str\$,list\$)

<u>Parameter</u>	<u>Description</u>
str\$	The string that will be trimmed.
List\$	Optional. The specific characters in list\$ will be removed.

Note:
This command has been supported since V6.59 EZ and later firmware.

Example

<u>Sample Code</u>	
DOWNLOAD "DEMO.BAS"	
data1\$="1234567"	
data2\$="a1234567a"	
data3\$="[<12345>]"	
SIZE 4,1.5	
GAP 0,0	
DIRECTION 1	
CLS	
TEXT 50,020,"3",0,1,1,"LTRIM\$(\"[\" +data1\$+\" \")	=\" +LTRIM\$(data1\$)
TEXT 50,050,\"3\",0,1,1,\"TRIM\$(\"[\" +data1\$+\" \")	=\" +TRIM\$(data1\$)
TEXT 50,080,\"3\",0,1,1,\"RTRIM\$(\"[\" +data1\$+\" \")	=\" +RTRIM\$(data1\$)
TEXT 50,110,\"3\",0,1,1,\"LTRIM\$(\"[\" +data2\$+\" \",\"[\"a\")[\"]	=\" +LTRIM\$(data2\$,\"a\")
TEXT 50,140,\"3\",0,1,1,\"TRIM\$(\"[\" +data2\$+\" \",\"[\"a\")[\"]	=\" +TRIM\$(data2\$,\"a\")
TEXT 50,170,\"3\",0,1,1,\"RTRIM\$(\"[\" +data2\$+\" \",\"[\"a\")[\"]	=\" +RTRIM\$(data2\$,\"a\")
TEXT 50,200,\"3\",0,1,1,\"LTRIM\$(\"[\" +data3\$+\" \",\"[\"[<>]\")[\"]	=\" +LTRIM\$(data3\$,\"[<>]\")
TEXT 50,230,\"3\",0,1,1,\"TRIM\$(\"[\" +data3\$+\" \",\"[\"[<>]\")[\"]	=\" +TRIM\$(data3\$,\"[<>]\")
TEXT 50,260,\"3\",0,1,1,\"RTRIM\$(\"[\" +data3\$+\" \",\"[\"[<>]\")[\"]	=\" +RTRIM\$(data3\$,\"[<>]\")
PRINT 1	
EOP	
DEMO	

<u>Result</u>	
LTRIM\$(\" 1234567 \")	= 1234567
TRIM\$(\" 1234567 \")	= 1234567
RTRIM\$(\" 1234567 \")	= 1234567
LTRIM\$(\"a1234567a\", \"a\")	= 1234567a
TRIM\$(\"a1234567a\", \"a\")	= 1234567
RTRIM\$(\"a1234567a\", \"a\")	= a1234567
LTRIM\$(\" [<12345>\", \"[<>]\")	= 12345>
TRIM\$(\" [<12345>\", \"[<>]\")	= 12345
RTRIM\$(\" [<12345>\", \"[<>]\")	= [<12345

See Also

TRIM\$(), RTRIM\$()

● RTRIM\$()

Description

Removes trailing blank space from a string.

Syntax

RTRIM\$(str\$ [, list\$])

Parameter	Description
str\$	The string that will be trimmed.
List\$	Optional. The specific characters in list\$ will be removed.

Note:
This command has been supported since V6.59 EZ and later firmware.

Example

Sample Code	
<pre>DOWNLOAD "DEMO.BAS" data1\$="1234567" data2\$="a1234567a" data3\$="[<12345>]" SIZE 4,1.5 GAP 0,0 DIRECTION 1 CLS TEXT 50,020,"3",0,1,1, "LTRIM\$(\"[\" +data1\$+\" \") = " +LTRIM\$(data1\$) TEXT 50,050,"3",0,1,1, "TRIM\$(\"[\" +data1\$+\" \") = " +TRIM\$(data1\$) TEXT 50,080,"3",0,1,1, "RTRIM\$(\"[\" +data1\$+\" \") = " +RTRIM\$(data1\$) TEXT 50,110,"3",0,1,1, "LTRIM\$(\"[\" +data2\$+\" \", \")a\") = " +LTRIM\$(data2\$, "a") TEXT 50,140,"3",0,1,1, "TRIM\$(\"[\" +data2\$+\" \", \")a\") = " +TRIM\$(data2\$, "a") TEXT 50,170,"3",0,1,1, "RTRIM\$(\"[\" +data2\$+\" \", \")a\") = " +RTRIM\$(data2\$, "a") TEXT 50,200,"3",0,1,1, "LTRIM\$(\"[\" +data3\$+\" \", \") [< > \") = " +LTRIM\$(data3\$, "[<>]") TEXT 50,230,"3",0,1,1, "TRIM\$(\"[\" +data3\$+\" \", \") [< > \") = " +TRIM\$(data3\$, "[<>]") TEXT 50,260,"3",0,1,1, "RTRIM\$(\"[\" +data3\$+\" \", \") [< > \") = " +RTRIM\$(data3\$, "[<>]") PRINT 1 EOP DEMO</pre>	
Result	
	<pre>LTRIM\$(" 1234567 ") = 1234567 TRIM\$(" 1234567 ") = 1234567 RTRIM\$(" 1234567 ") = 1234567 LTRIM\$("a1234567a", "a") = 1234567a TRIM\$("a1234567a", "a") = 1234567 RTRIM\$("a1234567a", "a") = a1234567 LTRIM\$("[<12345>]", "[<>]") = 12345> TRIM\$("[<12345>]", "[<>]") = 12345 RTRIM\$("[<12345>]", "[<>]") = [<12345</pre>

See Also

TRIM\$(), LTRIM\$()

● TEXTPIXEL()

Description

Returns the width of the text string in dot.

Syntax

TEXTPIXEL (cont\$,font\$,size)

<u>Parameter</u>	<u>Description</u>
cont\$	The content of text string.
Font \$	The font type. Please refer to the parameter <i>font</i> in command TEXT.
Size	The font size. Please refer to the parameter x-multiplication in command TEXT.

Note:
This command has been supported since V6.61 EZ and later firmware.

Example

<u>Sample code</u>	<u>Result</u>
<pre>DOWNLOAD "TEST.BAS" str\$="ABCDEFGG" font\$="3" fontsize=3 strwidth=TEXTPIXEL(str\$,font\$,fontsize) SIZE 4,1 GAP 0,0 DIRECTION 1 CLS TEXT 10,10,font\$,0,fontsize,fontsize,str\$ REVERSE 8,8,strwidth,72 PRINT 1 EOP TEST</pre>	

See Also

TEXT, BARCODEPIXEL()

● BARCODEPIXEL()

Description

Returns the width of barcode in dot.

Syntax

BARCODEPIXEL (cont\$, sym\$, narrow, wide)

<u>Parameter</u>	<u>Description</u>
cont\$	The content of barcode.
Sym \$	Barcode type. Please refer to the parameter code type in command BARCODE.
Narrow	The width of narrow bar. Please refer to the parameter narrow in command BARCODE.
Wide	The width of wide bar. Please refer to the parameter wide in command BARCODE.

Note:
This command has been supported since V6.72 EZ and later firmware.

Example

<u>Sample code</u>	<u>Result</u>
<pre>DOWNLOAD "TEST.BAS" cont\$="ABCDEFGG" sym\$="39" narrow=2 wide=6 codewidth=BARCODEPIXEL(cont\$,sym\$,narrow,wide) SIZE 4,1.5 GAP 0,0 DIRECTION 1 CLS BARCODE 10,10,sym\$,100,1,0,narrow,wide,cont\$ REVERSE 8,8,codewidth+8,132 BARCODE 10,160,sym\$,100,1,0,narrow,wide,cont\$ PRINT 1 EOP TEST</pre>	

See Also

BARCODE, TEXTPIXEL()

● VAL()

Description

This function converts numeric characters into corresponding integer or floating point number.

Syntax

VAL ("numeric character")

<u>Parameter</u>	<u>Description</u>
numeric character	" 0~9","."

Example

<u>Sample code</u>	<u>Result</u>
<pre>DOWNLOAD "DEMO.BAS" SIZE 4,1 GAP 0,0 DIRECTION 1 A\$="ABCDEFGHIJKLMNPOQRSTUVWXYZ" F\$="100" G\$="500" CLS H=VAL(F\$)+VAL(G\$) I\$=STR\$(H) TEXT 10,10, "3",0,1,1,A\$ TEXT 10,60, "3",0,1,1, "F=" +F\$ TEXT 10,110, "3",0,1,1, "G=" +G\$ TEXT 10,160, "3",0,1,1, "F+G=" +I\$ PRINT 1 EOP DEMO</pre>	<pre>ABCDEFGHIJKLMNPOQRSTUVWXYZ F=100 G=500 F+G=600</pre>

See Also

DOWNLOAD, EOP, END, LEFT\$(), LEN(), RIGHT\$(), MID\$(), STR\$()

● BEEP

Description

This command issues a beep sound on portable keyboard. Printer sends the string 0x07 to KP-200 portable keyboard.

Syntax

BEEP

Example

Sample code

```
DOWNLOAD "DEMO.BAS"  
SIZE 4,4  
GAP 0,0  
DIRECTION 1  
BEEP  
INPUT "Text1 =",TEXT1$  
CLS  
TEXT 100,100, "3",0,1,1,TEXT1$  
PRINT 1  
EOP
```

● NOW\$()

Description

Returns the current date and time according to the setting of your printer. The returned value always uses with commands FORMAT\$().

Syntax

NOW\$()

Note:

This command has been supported since V6.81 EZ and later firmware.

Example

Sample code
<pre>SIZE 4,1 GAP 0,0 DIRECTION 1 CLS TEXT 10,10, "3",0,1,1, "Now is " +NOW\$() TEXT 10,60, "3",0,1,1,FORMAT\$(NOW\$(),"Long Date") PRINT 1</pre>
Result
<pre>Now is 1/9/2013 2:19:27 PM Tuesday, January 09 2013</pre>

See Also

FORMAT\$()

● NOW

Description

Returns the total days since A.D. 1900. This global variable always uses with commands FORMAT\$() and DATEADD().

Syntax

NOW

Note:

This command has been supported since V6.87 EZ and later firmware.

Example

Sample Code

```
SIZE 4,1
GAP 0,0
DIRECTION 1
CLS
TEXT 10,10, "3",0,1,1, "Total days since a.d. 1900: " +STR$(NOW)+ " days"
TEXT 10,50, "3",0,1,1, "Date Info in RTC: " +FORMAT$(NOW, "General Date")
TEXT 10,90, "3",0,1,1, "Date after a year: " +FORMAT$(DATEADD("yyyy",1,NOW), "General Date")
PRINT 1
```

Result

```
Total days since a.d. 1900: 41283.597176 days
Date Info in RTC: 1/9/2013 2:19:56 PM
Date after a year: 1/9/2014 2:19:56 PM
```

See Also

FORMAT\$(), DATEADD(), NOW

● FORMAT\$()

Description

Returns the current date, time, number and number value according to the setting of your printer.

Syntax

FORMAT\$(expression[,style\$])

<u>Parameter</u>	<u>Description</u>
expression	Required. Any valid expression.
Style\$	Optional. A valid named or user-defined format string expression.

Predefined date/time formats	Description
General Date	Shows date and time.
Long Date	Uses the Long Date format.
Medium Date	Uses the dd-mmm-yy format.
Short Date	Uses the Short Date format.
Long Time	Shows the hour, minute, second, and "AM" or "PM" using the h:mm:ss format.
Medium Time	Shows the hour, minute, and "AM" or "PM" using the "hh:mm AM/PM" format.
Short Time	Shows the hour and minute using the hh:mm format.

User-defined date/time formats	Description
c	Display the date as dddd and display the time as tttt, in that order.
d	Display the day as a number without a leading zero (1 – 31).
dd	Display the day as a number with a leading zero (01 – 31).
ddd	Display the day as an abbreviation (Sun – Sat).
dddd	Display the day as a full name (Sunday – Saturday).
dddddd	Display a date serial number as a complete date (including day, month, and year), formatted according to your system's short date format setting. The default short date format is m/d/yyyy.
dddddd	Display the date as a complete date (including day, month, and year), formatted according to the long date setting recognized by your system. The default long date format is dddd, mmmm dd, yyyy.
w	Display the day of the week as a number (1 for Sunday through 7 for Saturday).
ww	Display the week of the year as a number (1 – 53).
m	Display the month as a number without a leading zero (1 – 12). If m immediately follows h or hh, the minute rather than the month is displayed.
mm	Display the month as a number with a leading zero (01 – 12). If mm immediately follows h or hh, the minute rather than the month is displayed.
mmm	Display the month as an abbreviation (Jan – Dec).
mmmm	Display the month as a full month name (January – December).
q	Display the quarter of the year as a number (1 – 4).
y	Display the day of the year as a number (1 – 366).
yy	Display the year as a 2-digit number (00 – 99).
yyyy	Display the year as a 4-digit number (100 – 9999).
h	Display the hour as a number without leading zeros (0 – 23).
hh	Display the hour as a number with leading zeros (00 – 23).
n	Display the minute as a number without leading zeros (0 – 59).
nn	Display the minute as a number with leading zeros (00 – 59).
s	Display the second as a number without leading zeros (0 – 59).
ss	Display the second as a number with leading zeros (00 – 59).
tttt	Display a time as a complete time (including hour, minute, and second). The default time format is h:mm:ss AM/PM.
AM/PM	Display an uppercase AM with any hour before noon; display an uppercase PM with any hour between noon and 11:59 P.M.
am/pm	Display a lowercase AM with any hour before noon; display a lowercase PM with any hour between noon and 11:59 P.M.

A/P	Display an uppercase A with any hour before noon; display an uppercase P with any hour between noon and 11:59 P.M.
a/p	Display a lowercase A with any hour before noon; display a lowercase P with any hour between noon and 11:59 P.M.
AMPM	AMPM can be either uppercase or lowercase, but the case of the string displayed matches the string as defined by your system settings.
\	Display the next character in the format string.
"string"	Display the string inside the double quotation marks.

Number formats (since A1.97)	Description
General Number	Displays the number as entered, with no rounding and no commas.
Currency	Displays the number with a dollar sign, comma (if appropriate), and two digits to the right of the decimal point. Shows negative numbers inside parentheses.
Fixed	Displays the number with at least one digit to the left of the decimal separator and two digits to the right. Does not show comma.
Standard	Displays the number with at least one digit to the left of the decimal separator and two digits to the right and commas (if appropriate).
Percent	Multiplies the value by 100 and displays the result with two digits to the right of the decimal point and a percent sign at the end.
Scientific	Uses standard scientific notation.
Yes/No	Any nonzero numeric value is Yes. Zero is No.
True/False	Any nonzero numeric value is True. Zero is False.
On/Off	Any nonzero numeric value is On. Zero is Off.

User-defined number formats (since A1.97)	Description
0	Digit placeholder. Displays a digit or a zero.
#	Digit placeholder. Displays a digit or nothing.
.	Decimal placeholder.
%	Percent placeholder. Multiplies the expression by 100.
,	Thousand separator.
E- E+ e- e+	Scientific format.
\	Display the next character in the format string.
"ABC"	Display the string inside the double quotation marks.

Different formats for different number values (since A1.97)	Description
One section only	The format expression applies to all values.
Two section	The first section applies to positive values and zeros; the second applies to negative values.
Three sections	The first section applies to positive values, the second applies to negative values, and the third applies to zeros.

Note:

This command has been supported since V6.81 EZ and later firmware.

See Also

NOW\$(), DATEADD(), NOW

Example

Sample Code	Result
<pre> SIZE 800 dot,1900 dot GAP 0,0 DIRECTION 1 CLS TEXT 15,10, "3",0,1,1, "General Date: "+FORMAT\$(NOW,"General Date") TEXT 15,60, "3",0,1,1, "Long Date: "+FORMAT\$(NOW,"Long Date") TEXT 15,110, "3",0,1,1, "Medium Date: "+FORMAT\$(NOW,"Medium Date") TEXT 15,160, "3",0,1,1, "Short Date: "+FORMAT\$(NOW,"Short Date") TEXT 15,210, "3",0,1,1, "Long Time: "+FORMAT\$(NOW,"Long Time") TEXT 15,260, "3",0,1,1, "Medium Time: "+FORMAT\$(NOW,"Medium Time") TEXT 15,310, "3",0,1,1, "Short Time: "+FORMAT\$(NOW,"Short Time") TEXT 15,360, "3",0,1,1, "c: "+FORMAT\$(NOW,"c") TEXT 15,410, "3",0,1,1, "d: "+FORMAT\$(NOW,"d") TEXT 15,460, "3",0,1,1, "dd: "+FORMAT\$(NOW,"dd") TEXT 15,510, "3",0,1,1, "ddd: "+FORMAT\$(NOW,"ddd") TEXT 15,560, "3",0,1,1, "dddd: "+FORMAT\$(NOW,"dddd") TEXT 15,610, "3",0,1,1, "ddddd: "+FORMAT\$(NOW,"ddddd") TEXT 15,660, "3",0,1,1, "dddddd: "+FORMAT\$(NOW,"dddddd") TEXT 15,710, "3",0,1,1, "w: "+FORMAT\$(NOW,"w") TEXT 15,760, "3",0,1,1, "ww: "+FORMAT\$(NOW,"ww") TEXT 15,810, "3",0,1,1, "m: "+FORMAT\$(NOW,"m") TEXT 15,860, "3",0,1,1, "mm: "+FORMAT\$(NOW,"mm") TEXT 15,910, "3",0,1,1, "mmm: "+FORMAT\$(NOW,"mmm") TEXT 15,960, "3",0,1,1, "mmmm: "+FORMAT\$(NOW,"mmmm") TEXT 15,1010, "3",0,1,1, "q: "+FORMAT\$(NOW,"q") TEXT 15,1060, "3",0,1,1, "y: "+FORMAT\$(NOW,"y") TEXT 15,1110, "3",0,1,1, "yy: "+FORMAT\$(NOW,"yy") TEXT 15,1160, "3",0,1,1, "yyyy: "+FORMAT\$(NOW,"yyyy") TEXT 15,1210, "3",0,1,1, "h: "+FORMAT\$(NOW,"h") TEXT 15,1260, "3",0,1,1, "hh: "+FORMAT\$(NOW,"hh") TEXT 15,1310, "3",0,1,1, "n: "+FORMAT\$(NOW,"n") TEXT 15,1360, "3",0,1,1, "nn: "+FORMAT\$(NOW,"nn") TEXT 15,1410, "3",0,1,1, "s: "+FORMAT\$(NOW,"s") TEXT 15,1460, "3",0,1,1, "ss: "+FORMAT\$(NOW,"ss") TEXT 15,1510, "3",0,1,1, "tttt: "+FORMAT\$(NOW,"tttt") TEXT 15,1560, "3",0,1,1, "AM/PM: "+FORMAT\$(NOW,"AM/PM") TEXT 15,1610, "3",0,1,1, "am/pm: "+FORMAT\$(NOW,"am/pm") TEXT 15,1660, "3",0,1,1, "A/P: "+FORMAT\$(NOW,"A/P") TEXT 15,1710, "3",0,1,1, "a/p: "+FORMAT\$(NOW,"a/p") TEXT 15,1760, "3",0,1,1, "AMPM: "+FORMAT\$(NOW,"AMPM") TEXT 15,1810, "3",0,1,1, "\" +FORMAT\$(NOW,"To\da\y i\s dddd") TEXT 15,1860, "3",0,1,1, "string: "+FORMAT\$(NOW,"To\da\y i\s dddd") PRINT 1 </pre>	<pre> General Date:1/9/2013 2:46:18 PM Long Date:Tuesday, January 09 2013 Medium Date:09-Jan-13 Short Date:1/9/2013 Long Time:2:46:18 PM Medium Time:02:46 PM Short Time:14:46 c:1/9/2013 2:46:18 PM d:9 dd:09 ddd:Tue dddd:Tuesday ddddd:1/9/2013 dddddd:Tuesday, January 09 2013 w:3 ww:2 m:1 mm:01 mmm:Jan mmmm:January q:1 y:9 yy:13 yyyy:2013 h:14 hh:14 n:46 nn:46 s:18 ss:18 tttt:2:46:18 PM AM/PM:PM am/pm:pm A/P:P a/p:p AMPM:PM \:Today is 1/9/2013 string:Today is 1/9/2013 </pre>

Sample Code (Since A1.97)	Result
<pre> SIZE 800 dot,850 dot GAP 0,0 DIRECTION 1 CLS TEXT 15,10, "3",0,1,1, "General Number: "+FORMAT\$(1234.5,"General Number") TEXT 15,60, "3",0,1,1, "Currency: "+FORMAT\$(1234.5,"Currency") TEXT 15,110, "3",0,1,1, "Fixed: "+FORMAT\$(1234.5,"Fixed") TEXT 15,160, "3",0,1,1, "Standard: "+FORMAT\$(1234.5,"Standard") TEXT 15,210, "3",0,1,1, "Percent: "+FORMAT\$(1234.5,"Percent") TEXT 15,260, "3",0,1,1, "Scientific: "+FORMAT\$(1234.5,"Scientific") TEXT 15,310, "3",0,1,1, "Yes/No: "+FORMAT\$(1234.5,"Yes/No") TEXT 15,360, "3",0,1,1, "Yes/No: "+FORMAT\$(0,"Yes/No") TEXT 15,410, "3",0,1,1, "True/False: "+FORMAT\$(0,"True/False") TEXT 15,460, "3",0,1,1, "On/Off: "+FORMAT\$(0,"On/Off") TEXT 15,510, "3",0,1,1, "00000.00: "+FORMAT\$(1234.5,"00000.00") TEXT 15,560, "3",0,1,1, "#####.##: "+FORMAT\$(1234.5,"#####.##") TEXT 15,610, "3",0,1,1, "##,##0.00: "+FORMAT\$(1234.5,"##,##0.00") TEXT 15,660, "3",0,1,1, "\$##0.00: "+FORMAT\$(1234.5,"\$##0.00") TEXT 15,710, "3",0,1,1, "\$0.00%: "+FORMAT\$(1234.5,"0.00%") TEXT 15,760, "3",0,1,1, "Yes/No: "+FORMAT\$(-12.3,"Yes/No") TEXT 15,810, "3",0,1,1, "0.00;(0.00): "+FORMAT\$(-12.3,"0.00;(0.00)") PRINT 1 </pre>	<pre> General Number: 1234.5 Currency: \$1,234.50 Fixed: 1234.50 Standard: 1,234.50 Percent: 123450.00% Scientific: 1.23E+03 Yes/No: Yes Yes/No: No True/False: False On/Off: Off 00000.00: 01234.50 #####.##: 1234.5 ##,##0.00: 1,234.50 \$##0.00: \$1234.50 \$0.00%: 123450.00% Yes/No: Yes 0.00;(0.00): (12.30) </pre>

● DATEADD()

Description

Returns a date after which a specified time/date interval has been added. The returned value always uses with commands FORMAT\$().

Syntax

DATEADD(interval\$,number,date)

<u>Parameter</u>	<u>Description</u>																						
interval\$,	The time/date interval for adding. It can be one of following values. <table border="1" data-bbox="555 533 1121 898"> <thead> <tr> <th>Interval\$</th> <th>The interval unit of parameter interval\$</th> </tr> </thead> <tbody> <tr> <td>"yyyy"</td> <td>Year.</td> </tr> <tr> <td>"q"</td> <td>Quarter.</td> </tr> <tr> <td>"m"</td> <td>Month.</td> </tr> <tr> <td>"y"</td> <td>Day of year.</td> </tr> <tr> <td>"d"</td> <td>Day.</td> </tr> <tr> <td>"w"</td> <td>Weekday.</td> </tr> <tr> <td>"ww"</td> <td>Week of year.</td> </tr> <tr> <td>"h"</td> <td>Hour.</td> </tr> <tr> <td>"n"</td> <td>Minute.</td> </tr> <tr> <td>"s"</td> <td>Second.</td> </tr> </tbody> </table>	Interval\$	The interval unit of parameter interval\$	"yyyy"	Year.	"q"	Quarter.	"m"	Month.	"y"	Day of year.	"d"	Day.	"w"	Weekday.	"ww"	Week of year.	"h"	Hour.	"n"	Minute.	"s"	Second.
Interval\$	The interval unit of parameter interval\$																						
"yyyy"	Year.																						
"q"	Quarter.																						
"m"	Month.																						
"y"	Day of year.																						
"d"	Day.																						
"w"	Weekday.																						
"ww"	Week of year.																						
"h"	Hour.																						
"n"	Minute.																						
"s"	Second.																						
Number	The number of interval\$ for adding.																						
Date	The date which is used to add the interval\$. Date format: "yyyy/mm/dd" Time format: "hh:nn:ss"																						
Note:	<i>This command has been supported since V6.87 EZ and later firmware.</i>																						

Example

<u>Sample Code 1</u>	<u>Result 1</u>
<pre> SIZE 4,2 GAP 0,0 DIRECTION 1 CLS TEXT 10,10, "3",0,1,1, "Current RTC info: " +NOW\$() TEXT 10,60, "3",0,1,1, "-1 year: " +FORMAT\$(DATEADD("yyyy",-1, " 11/26/2012 10:08:00"), "yyyy/mm/dd hh:nn:ss") TEXT 10,110, "3",0,1,1, "+9 months: " +FORMAT\$(DATEADD("m",9,NOW), "Short Date") TEXT 10,160, "3",0,1,1, "-8 hours: " +FORMAT\$(DATEADD("h",-8,NOW), "Short Time") TEXT 10,210, "3",0,1,1, "+5 mins: " +FORMAT\$(DATEADD("n",5,NOW), "Short Time") TEXT 10,260, "3",0,1,1, "+00 day: " +FORMAT\$(NOW, "Short Date") TEXT 10,310, "3",0,1,1, "+20 days: " +FORMAT\$(DATEADD("d",20,NOW), "Short Date") TEXT 10,360, "3",0,1,1, "-20 day: " +FORMAT\$(DATEADD("d",-20,NOW), "Short Date") PRINT 1 </pre>	<pre> Current RTC info: 1/9/2013 3:20:06 PM -1 year: 2011/11/26 10:08:00 +9 months: 10/9/2013 -8 hours: 07:20 +5 mins: 15:25 +00 day: 1/9/2013 +20 days: 1/29/2013 -20 day: 12/20/2012 </pre>

Sample Code 2

SIZE 4,2

GAP 0,0

DIRECTION 1

CLS

TEXT 10,60,"3",0,1,1,"-1 year: "+FORMAT\$(DATEADD("yyyy",-1,"11/26/2012 10:08"),"yyyy/mm/dd hh:nn AM/PM")

TEXT 10,110,"3",0,1,1,"+9 months: "+FORMAT\$(DATEADD("m",9,"11/26/2012 10:08"),"yyyy/mm/dd hh:nn AM/PM")

TEXT 10,160,"3",0,1,1,"+8 hours: "+FORMAT\$(DATEADD("h",+8,"11/26/2012 10:08"),"yyyy/mm/dd hh:nn AM/PM")

TEXT 10,210,"3",0,1,1,"+00 day: "+FORMAT\$("11/26/2012 10:08:00","yyyy/mm/dd hh:nn AM/PM")

TEXT 10,260,"3",0,1,1,"+20 days: "+FORMAT\$(DATEADD("d",20,"11/26/2012 10:08"),"yyyy/mm/dd hh:nn AM/PM")

TEXT 10,310,"3",0,1,1,"-20 days: "+FORMAT\$(DATEADD("d",-20,"11/26/2012 10:08"),"yyyy/mm/dd hh:nn AM/PM")

PRINT 1

Result 2

-1 year: 2011/11/26 10:08 AM

+9 months: 2013/08/26 10:08 AM

+8 hours: 2012/11/26 06:08 PM

+00 day: 2012/11/26 10:08 AM

+20 days: 2012/12/16 10:08 AM

-20 days: 2012/11/06 10:08 AM

● FSEARCH()

Description

This function returns the position of a string.

Syntax

FSEARCH(file handle, STR\$)

<u>Parameter</u>	<u>Description</u>
file handle	0 or 1
STR\$	Required. Any valid string expression.

Note:
This command has been supported since A1.88 EZ and later firmware.

Example

<u>Sample Code</u>	<u>Result</u>
<pre>DOWNLOAD "DATA1",10,1234567890 DOWNLOAD "DATA2",15,ABCDEFGHIJKLMNO DOWNLOAD "Test.BAS" SIZE 4,1.5 GAP 0,0 DIRECTION 1 CLS OPEN "DATA1",0 OPEN "DATA2",1 TEXT 10,90,"4",0,1,1,"FSEARCH() FUNCTION TEST" A=FSEARCH(0,"8") B=FSEARCH(1,"J") TEXT 10,140,"3",0,1,1,"8 position is:"+STR\$(A) TEXT 10,180,"3",0,1,1,"J position is:"+STR\$(B) PRINT 1 EOP Test</pre>	<pre>FSEARCH() FUNCTION TEST 8 position is: 7 J position is: 9</pre>

● TOUCHPRESS()

Description

This command is used to detect the status of touch screen. Returns 1 if the touch screen for the specified region is pressed, otherwise returns 0.

Syntax

TOUCHPRESS (left, top, right, bottom)

<u>Parameter</u>	<u>Description</u>
left	Left side position of region (pixel)
top	Top side position of region (pixel)
right	Right side position of region (pixel)
bottom	Bottom side position of region (pixel)

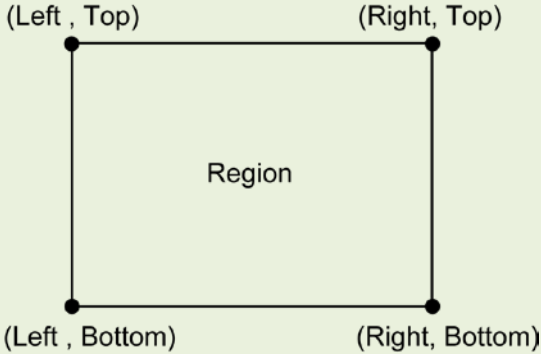

Note:

- *This command has been supported since A1.76 EZ and later firmware*
- *This command only can be performed on the printer with touch screen. 272(W) x 480(H) pixels for MT & MX series*

Example

Sample Code

```
DOWNLOAD "DEMO.BAS"  
:START  
IF TOUCHPRESS(0,90,272,120) <> 0 THEN GOTO A  
GOTO START  
ENDIF  
:A  
CLS  
SIZE 4,1  
GAP 0,0  
DIRECTION 1  
TEXT 30,30,"3",0,1,1,"TOUCH TEST!!"  
PRINT 1,1  
EOP  
DEMO
```

● RECORDSET\$ ()

Description

This function returns a value from a table. Table is represented in a grid format, tabular form in rows and columns. Please refer to following table format on example.

Syntax

RECORDSET\$(TABLE\$, ROW, COLUMN [, DELIMITER])

<u>Parameter</u>	<u>Description</u>
TABLE\$	Table name
ROW	Number of row
COLUMN	Number (or name) of column
DELIMITER	Optional. Set the delimiter of table. The default is 09H <Tab>

Note: The Row is always a number. But the column can be a number or name

Example

<u>Sample Code 1:</u>	<u>Result</u>																									
<pre> DOWNLOAD F,"TEST.CSV",75,3 Name,Age,Height,Weight John,18,180,80 Mary,30,150,50 Mark,65,170,65 DOWNLOAD F,"TEST.BAS" CLOSE 0 SIZE 4,2 GAP 0,0 DIRECTION 1 CLS TEXT 100,50,"3",0,1,1,"Row 1 and Column 1 = " + RECORDSET\$("TEST.CSV", 1, 1, ASC(", ")) TEXT 100,100,"3",0,1,1,"Row 2 and Column 1 = " + RECORDSET\$("TEST.CSV", 2, 1, ASC(", ")) TEXT 100,150,"3",0,1,1,"John Age = " + RECORDSET\$("TEST.CSV", 1, 2, ASC(", ")) TEXT 100,200,"3",0,1,1,"Mary Age = " + RECORDSET\$("TEST.CSV", 2, 2, ASC(", ")) TEXT 100,250,"3",0,1,1,"John Height = " + RECORDSET\$("TEST.CSV",1,"Height", ASC(", ")) TEXT 100,300,"3",0,1,1,"Mary Height = " + RECORDSET\$("TEST.CSV",2,"Height", ASC(", ")) PRINT 1 EOP TEST </pre>	<pre> Row 1 and Column 1 = John Row 2 and Column 1 = Mary John Age = 18 Mary Age = 30 John Height = 180 Mary Height = 150 </pre> <p>Table format (TEST.CSV)</p> <table border="1"> <tr> <td>Number of rows</td> <td colspan="4">3</td> </tr> <tr> <td>Name of column</td> <td>Name</td> <td>Age</td> <td>Height</td> <td>Weight</td> </tr> <tr> <td>Row 1</td> <td>John</td> <td>18</td> <td>180</td> <td>80</td> </tr> <tr> <td>Row 2</td> <td>Mary</td> <td>30</td> <td>150</td> <td>50</td> </tr> <tr> <td>Row 3</td> <td>Mark</td> <td>65</td> <td>170</td> <td>65</td> </tr> </table> <p>Column 1 Column 2 Column 3 Column 4</p>	Number of rows	3				Name of column	Name	Age	Height	Weight	Row 1	John	18	180	80	Row 2	Mary	30	150	50	Row 3	Mark	65	170	65
Number of rows	3																									
Name of column	Name	Age	Height	Weight																						
Row 1	John	18	180	80																						
Row 2	Mary	30	150	50																						
Row 3	Mark	65	170	65																						

Sample Code 2: (since VA1.97)

```
DOWNLOAD "TEST.CSV",121,6,  
Number,String  
1234,ABCD  
"12,34","AB,CD"  
"12  
34","AB  
CD"  
"12""34","AB""CD"  
""1234","""ABCD"  
"1234""","ABCD"""
```

```
OUT RECORDSET$("TEST.CSV", 1, "Number", ASC(","))  
OUT RECORDSET$("TEST.CSV", 2, 1, ASC(","))  
OUT RECORDSET$("TEST.CSV", 3, 1, ASC(","))  
OUT RECORDSET$("TEST.CSV", 4, 1, ASC(","))  
OUT RECORDSET$("TEST.CSV", 5, 1, ASC(","))  
OUT RECORDSET$("TEST.CSV", 6, 1, ASC(","))
```

```
OUT ""
```

```
OUT RECORDSET$("TEST.CSV", 1, "String", ASC(","))  
OUT RECORDSET$("TEST.CSV", 2, 2, ASC(","))  
OUT RECORDSET$("TEST.CSV", 3, 2, ASC(","))  
OUT RECORDSET$("TEST.CSV", 4, 2, ASC(","))  
OUT RECORDSET$("TEST.CSV", 5, 2, ASC(","))  
OUT RECORDSET$("TEST.CSV", 6, 2, ASC(","))
```

Table format (TEST.CSV)

Number of rows	6	
Name of column	Number	String
Row 1	1234	ABCD
Row 2	12,34	AB,CD
Row 3	12 34	AB CD
Row 4	12"34	AB"CD
Row 5	"1234	"ABCD
Row 6	1234"	ABCD"

Column 1 Column 2

Return

```
1234  
12, 34  
12  
34  
12"34  
"1234  
1234"  
  
ABCD  
AB, CD  
AB  
CD  
AB"CD  
"ABCD  
ABCD"
```

● LABELRATIO

Description

This command returns label print ratio.

Syntax

LABELRATIO

Note:

This command has been supported since V8.00 EZ and later firmware

Example

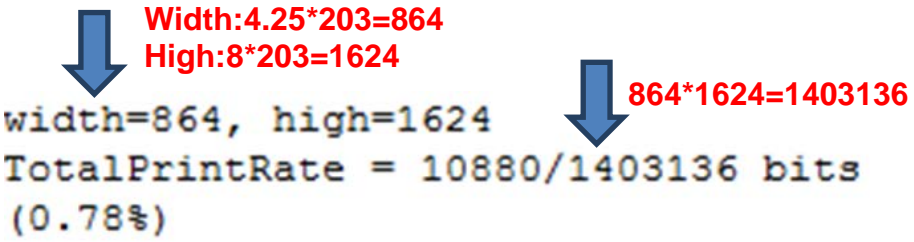
Sample Code	Result
LABELRATIO	 <p>Width: $4.25 * 203 = 864$ High: $8 * 203 = 1624$</p> <p>width=864, high=1624</p> <p>TotalPrintRate = 10880/1403136 bits (0.78%)</p>

Device Reconfiguration Commands

● SET COUNTER

Description

Counters can be a real counter or a variable. This setting sets the counter number in the program and its increments. There are three different types of counters: digit (0~9~0), lower case letter (a~z~a) or upper case letter (A~Z~A).

Syntax

SET COUNTER @n step
@n= "Expression "

<u>Parameter</u>	<u>Description</u>
@n	n: counter number. There are 61 counters available (@0 ~ @60) in the printer. @0 to @50 will be cleared while restarting the printer. @51 to @60 will be stored in printer until the printer is restored to factory default. @51~@55 were supported since V6.37 EZ. @56~@60 were supported since V6.74 EZ.
Step	The increment of the counter, can be positive or negative. -999999999 <= step <= 999999999 <i>If the counter is used as a fixed variable, please set the increment to 0.</i>
Expression	Initial string. String length is 101 bytes

Example

<u>Sample Code</u>	<u>Result</u>
<pre> SET COUNTER @0 +1 SET COUNTER @1 +0 SET COUNTER @2 -1 SET COUNTER @3 1 @0=" 0001" @1=" 0101" @2=" 000A" @3=" 1" SIZE 4,0.5 GAP 0,0 DIRECTION 1 CLS TEXT 600,10," 3",0,1,1,3," @0 @1 @2" TEXT 600,30," 3",0,1,1,3,« Label" +@3+" -----" TEXT 600,50,"3",0,1,1,3,@0+" " +@1+" " +@2" PRINT 5 </pre>	<pre> Label 5 ---@0-----@1-----@2 0005 0101 999W Label 4 ---@0-----@1-----@2 0004 0101 999X Label 3 ---@0-----@1-----@2 0003 0101 999Y Label 2 ---@0-----@1-----@2 0002 0101 999Z Label 1 ---@0-----@1-----@2 0001 0101 000A </pre>

See Also

PRINT, TEXT, BARCODE

● SET CUTTER

Description

This setting activates or deactivates the cutter and defines how many printed labels is to be cut at one time. This setting will be saved in printer memory after turning off the power.

Syntax

SET CUTTER OFF/BATCH/pieces

<u>Parameter</u>	<u>Description</u>
OFF	Disable cutter function.
BATCH	Set printer to cut label at the end of printing job.
Pieces	Set number of printing labels per cut. 0<= pieces <=65535

Note:

- *Care label cutter module was supported since V6.86 EZ in industrial printer TTP-2410M series.*
- *Since V6.86 EZ, if cutter is not installed, the cutter error doesn't happen even SET CUTTER ON is set.*

Example

<u>Sample code</u>	<u>Result</u>
SIZE 3,3 GAP 0,0 SET CUTTER OFF SET PEEL OFF CLS TEXT 50,50, "3",0,1,1, "SET CUTTER OFF" PRINT 3	The cutter function is disabling.
SET CUTTER BATCH CLS TEXT 50,50, "3",0,1,1, "SET CUTTER BATCH" PRINT 3,2	The cutter cuts once after 6 labels are printed.
SET CUTTER 1 CLS TEXT 50,50, "3",0,1,1, "SET CUTTER 1" PRINT 3,2	The cutter cuts every label.
CLS TEXT 50,50, "3",0,1,1, "SET CUTTER 2" PRINT 3,2	The cutter cuts every 2 labels.

See Also

OFFSET, PRINT, SET PARTIAL_CUTTER

● SET PARTIAL_CUTTER

Description

This setting activates or deactivates the cutter and defines how many printed labels is to be cut at one time. This setting will be saved in printer memory after turning off the power. This function prevents label back feeding after a cut.

Syntax

SET PARTIAL_CUTTER OFF/BATCH/Pieces

<u>Parameter</u>	<u>Description</u>
OFF	Disable cutter function.
BATCH	Set printer to cut label at the end of printing job.
Pieces	Set number of printing labels per cut. 0<= pieces <=65535

Note: This command is supported for the printer that have cutter module.

Example

Sample code

```
REM **SET PARTIAL_CUTTER FUNCTION OFF EXAMPLE PROGRAM**
SIZE 3,1
GAP 0,0
DENSITY 8
SPEED 6
DIRECTION 0
REFERENCE 0,0
SET PARTIAL_CUTTER OFF
CLS
TEXT 50,50, "3",0,1,1, "SET PARTIAL_CUTTER OFF"
PRINT 3
REM ***This program cuts once at the batch***
SET PARTIAL_CUTTER BATCH
CLS
TEXT 50,50, "3",0,1,1, "SET PARTIAL_CUTTER BATCH"
PRINT 3,2
REM ***This program cuts every label***
SET PARTIAL_CUTTER 1
CLS
TEXT 50,50, "3",0,1,1, " SET PARTIAL_CUTTER 1"
PRINT 3,2
REM ***This program cuts 2 label***
SET PARTIAL_CUTTER 2
CLS
TEXT 50,50, "3",0,1,1, "SET PARTIAL_CUTTER 2"
PRINT 3,2
```

See Also

OFFSET, PRINT, SET CUTTER

● SET BACK

Description

This setting is used after SET CUTTER function. This function prevents label backfeeding after a cut.

Syntax

SET BACK OFF/ON

<u>Parameter</u>	<u>Description</u>
OFF	Disable back function.
ON	Enable back function.

Note: TDP-643 Plus , TTP-243, TTP-342, TTP-244ME, TTP-342M and TTP-248M series are not supported this feature

Example

Sample code

```
REM **SET BACK FUNCTION OFF EXAMPLE PROGRAM**
SIZE 3,1
GAP 0,0
DENSITY 8
SPEED 6
DIRECTION 1
REFERENCE 0,0
SET CUTTER 1
SET BACK OFF
CLS
TEXT 50,50, "3",0,1,1, "SET BACK OFF "
PRINT 3
CLS
SET CUTTER 1
SET BACK ON
TEXT 50,50, "3",0,1,1, "SET BACK ON "
PRINT 3
```

See Also

OFFSET, PRINT, SET CUTTER

● SET KEYn

Description

This setting is used to enable/disable the KEYn function. Before setting KEYn function, please disable the default function of KEYn first. The setting will remain resident in the printer even when the printer is power off.

Syntax

SET KEYn ON/OFF/DEFAULT/MENU/PAUSE/PRINT m/FEED/BACKFEED/FORMFEED/CUT/INPUT "string "

<u>Parameter</u>	<u>Description</u>
n	0, 1, 2, 3, 4, 5, 6
ON	Enable KEYn function
OFF	Disable KEYn function
DEFAULT	Resume KEYn default function
MENU	Set to "MENU " key
PAUSE	Set to "PAUSE " key
PRINT m	Set to "PRINT " key m: Set number of printing labels per print. (0 < m < 32000)
FEED	Set to "FEED " key that can manual control the feeding distance
BACKFEED	Set to "BACKFEED " key that can manual control the backfeeding distance
FORMFEED	Set to "FORMFEED " key that will feed the label under the format. Ex: If format is "size 4,6, it will feed 6 ".
CUT	Set to "CUT " key
INPUT "string "	Send the command by press key (ex: SET KEY1 INPUT "CONFIG " + CHR\$(13) + CHR\$(10))

The default function of KEYn is as listed below:

Model	KEY0	KEY1	KEY2	KEY3	KEY4	KEY5	KEY6
TDP-643 Plus/ 643R Plus		PAUSE					
TTP-243/243 Plus/243 Pro series, TTP-244ME/244 ME Plus/244M Pro series, TTP-244/244 Plus series		PAUSE	FEED				
TDP-245/247 series, TTP-245/247 series, TTP-245C series, TDP-225 series, TTP-225 series, TA200 series, Alpha-3R, DA series, TE series, Alpha-2R		FEED					
TX200 series (with LCD), TC210 series (with LCD), TX600 series, MX240P series, MH series		FEED	MENU	UP	RIGHT	LEFT	DOWN
TTP-246M series		MENU	PAUSE	FEED	(UP)	(DOWN)	(SELECT)
TTP-248M series		MENU	PAUSE	FEED			
TTP-2410M/2410M Pro series, TTP-246M Plus/246M Pro series, TTP-268M series, TTP-384M series, ME240(LCD control panel) series		MENU	PAUSE	FEED	UP	DOWN	SELECT
ME240 (Non-LCD control panel) series		FEED	PAUSE				
M23 series	FEED	LEFT	MID	RIGHT			
Alpha-4L		FEED	INFO	MENU			
MX240 series, TTP-2410MT/MU series		PAUSE	MENU	FEED	UP	SELECT	DOWN

Example

Sample code

```
DOWNLOAD "DEMO.BAS"
SIZE 3,1
GAP 0,0
DENSITY 8
SPEED 3
DIRECTION 0
REFERENCE 0,0
SET CUTTER OFF
SET KEY1 OFF
SET KEY2 OFF
SET KEY3 OFF
KEY1=0
KEY2=0
KEY3=0

:START
IF KEY1=1 THEN
CLS
TEXT 100,10, "3",0,1,1, "KEY1 (MENU key) is pressed!! "
PRINT 1,1
ELSEIF KEY2=1 THEN
CLS
TEXT 100,10, "3",0,1,1, "KEY2 (PAUSE key) is pressed!! "
PRINT 1,1
ELSEIF KEY3=1 THEN
CLS
TEXT 100,10, "3",0,1,1, "KEY3 (FEED key) is pressed!! "
TEXT 100,60, "3",0,1,1, "End of test"
PRINT 1,1
SET KEY1 ON
SET KEY2 ON
SET KEY3 ON
END
ENDIF
GOTO START
EOP
DEMO
```

See Also

OFFEST, PRINT

● SET LEDn

Description

This setting is used to control LED on/off function.

Syntax

SET LED1 ON/OFF

SET LED2 ON/OFF

SET LED3 ON/OFF

<u>LED no.</u>	<u>Default Function</u>							
LDE1	Power on/off							
LED2	Printer on-line/off-line							
LED3	Error/normal							
<u>Parameter</u>	<u>Description</u>							
ON	Enable LEDn function							
OFF	Disable LEDn function							

The default function of LED1, LED2 and LED3 id as listed below:

Model	LED1	LED2	LED3	LED4	LED5	LED6	LED7	LED2 & LED3
TDP-643 Plus/ 643R Plus series	ONLINE	ERROR	ERROR					
TTP-243/243 Plus/243 Pro series, TTP-244ME/244 ME Plus/244M Pro series, TTP-244/ 244 Plus series TTP-2410M/2410M Pro series, TTP-246M Plus/246M Pro series, TTP-268M series, TTP-384M series, ME240 series, MX240 series, MX240P series	POWER	ONLINE	ERROR					
TDP-245/247 series, TTP-245/247 series, TTP-245C series, TDP-225 series, TTP-225 series, DA200 series, TA200 series, TC210series, TE200 series, MH series Note: For this series, the LED1=LED2	GREEN	GREEN	RED					ORANGE
Alpha-2R series , Alpha-3R series	GREEN	RED	BAT1	BAT2	BAT3	BT/WIFI		ORANGE
Alpha-4L series	GREEN	RED	BAT1	BAT2	BAT3	BT	WIFI	ORANGE

Note: Please refer to [printer model list](#) for checking series printers.

Example

Sample code

```

DOWNLOAD "DEMO4.BAS "
SET LED1 OFF
SET LED2 OFF
SET LED3 OFF
FOR I=1 TO 100
LED1=0
LED2=0
LED3=0
IF I-INT(I/2)*2=0 THEN
LED1=1

```

```
ELSEIF I-INT(I/3)*3=0 THEN
```

```
LED2=1
```

```
ELSE
```

```
LED3=1
```

```
ENDIF
```

```
NEXT
```

```
LED1=1
```

```
LED2=1
```

```
LED3=0
```

```
SET LED1 ON
```

```
SET LED2 ON
```

```
SET LED3 ON
```

```
EOP
```

```
DEMO4
```

● SET PEEL

Description

This setting is used to enable/disable the self-peeling function. The default setting for this function is off. When this function is set on, the printer stops after each label printing, and does not print the next label until the peeled label is taken away. This setting will be saved in printer memory when turning off the power.

Syntax

SET PEEL ON/OFF

<u>Parameter</u>	<u>Description</u>
ON	Enable the self-peeling function
OFF	Disable the self-peeling function

Example

Sample code

```
REM ***SELF-PEELING FUNCTION ON***  
SIZE 4,4  
GAP 0,0  
DENSITY 8  
SPEED 6  
DIRECTION 0  
REFERENCE 0,0  
SET CUTTER OFF  
SET PEEL ON  
CLS  
TEXT 50,100, "3 ",0,1,1, "SELF-PEELING FUNCTION TEST "  
PRINT 5
```

See Also

OFFEST, PRINT

● SET REWIND

Description

This setting is used to enable/disable the internal rewind function for MX240/TTP-2610MT series & external rewind module (via RS-232 port). The default setting for this function is off. When this function is set on, the printer rewind spindle will rewind the printed labels. This setting will be saved in printer memory when turning off the power.

Syntax

SET REWIND ON/OFF/RS232

<u>Parameter</u>	<u>Description</u>
ON	Enable the internal rewind function
OFF	Disable the internal rewind or external rewind module function
RS232	Enable the external rewind module function (via RS-232 port/ pull high signal)

Note: The function of external rewind module has been supported since A1.92 and later firmware.

Example

Sample code

```
REM ***REWIND FUNCTION ON***  
SIZE 4,4  
GAP 0.12,0  
DENSITY 8  
SPEED 6  
DIRECTION 0  
REFERENCE 0,0  
SET CUTTER OFF  
SET REWIND ON  
CLS  
TEXT 50,100, "3 ",0,1,1, "REWIND FUNCTION TEST "  
PRINT 500
```

See Also

OFFEST, PRINT

● SET TEAR & SET STRIPER

Description

This command is used to enable/disable feeding of labels to gap/black mark position for tearing off. This setting will be saved in printer memory when turning off the power.

Syntax

SET TEAR ON/OFF (TSPL2 language printers only)
SET STRIPER ON/OFF (TSPL language printers only)

Note: Please refer to [printer model list](#) for checking TSPL or TSPL2

<u>Parameter</u>	<u>Description</u>
ON	The label gap will stop at the tear off position after print.
OFF	The label gap will NOT stop at the tear off position after print. The beginning of label will be aligned to print head.

Example

Sample code

```
REM ***TEAR FUNCTION ON***  
SIZE 3,3  
GAP 0.08,0  
DENSITY 8  
SPEED 4  
DIRECTION 0  
REFERENCE 0,0  
SET CUTTER OFF  
SET PEEL OFF  
SET TEAR ON  
CLS  
TEXT 50,100, "3 ",0,1,1, "TEAR FUNCTION TEST "  
PRINT 1
```

See Also

SET PEEL, SET CUTTER

● SET GAP

Description

This setting sets the gap sensor emission sensitivity. The printer initiates automatic gap sensor calibration when the PAUSE key is held down while powering up. This function may cease to work if the thickness of the backing paper and that of label with backing paper are not of appreciable difference to the sensor, or when there are pre-printed marks or patterns on the label. In such case, users must calibrate the gap sensor manually by this command through trial-and-error method to attain the proper setting. This setting will be saved in printer memory when turning off the power.

Syntax

SET GAP n/AUTO/OFF/0,/REVERSE/OBVERSE

<u>Parameter</u>	<u>Description</u>
N	Gap sensor light emission strength. Available range is listed as below. 0 is the lowest sensitivity
AUTO	The printer will feed 2 or 3 labels to calibrate the gap. If the label is continuous, the printer will feed label to limit 10~20 inches to confirm if the label is continuous.
OFF	Disable the SET GAP AUTO function.
0,	Automatically calibrate the gap size.
REVERSE	This function is used when the Black Mark is the separation in the front of the label and which can't be detected by the Black Mark sensor. The parts of the media which can be passed through by GAP sensor are defined to be the printable area, otherwise it will be defined to the GAP of the media.
OBVERSE	Disable the "SET GAP REVERSE " function.

Printer model	Gap Sensor Range	Black Mark Sensor Range	SET GAP REVERSE SET GAP OBVERSE SET GAP AUTO
TTP-243 series, TTP-244ME series, TDP-643 Plus series, TTP-342 series, TTP-342M series	0~15	ON/OFF	V
TTP-243 Plus series, TTP-244 series, TTP-244ME Plus series, TDP-643R Plus series, TTP-342 Plus series	0~255	ON/OFF	V
TTP-243 Pro series, TTP-244 Plus series	0~63	ON/OFF	
TTP-245C series, TTP-225 series, TDP-225 series	0~31	0~3	V
TTP-245/343 series, TDP-245 series, TTP-246M/344M series (non usb)	0~63	0~63	V
TTP-245 Plus/343 Plus series, TDP-245 Plus series, TTP-247 series, TDP-247 series	0~15	0~15	V
TTP-246M/344M series (usb)	0~31	0~31	V
TTP-246M Plus, TTP-2410M series, TTP-344M Plus series, TTP-346M series, TTP-384M series, TTP-644M series, ME240 series	0~7	0~3	V
TTP-2410M Pro series	0~7	0~7	V
TTP-248M series, M23 series	0~255	0~255	V
TA200 series	0~15	0~3	V
Alpha-4L series	0~15	0~7	V

Note:

* When in "SET HEAD OFF " mode, the function "SET GAP AUTO " doesn't work even the printer head is opened and closed, but it can work when power on the printer.

* Please refer to [printer model list](#) for checking series printers.

Example

The example below is operated in DOS environment via the parallel port connection to setup the label size, gap distance and sensor sensitivity.

```
C:\>COPY CON LPT1<ENTER>
SIZE 4,2.5<ENTER>
GAP 0.12,0<ENTER>
SET GAP 1<ENTER>
<CTRL><Z><ENTER>
C:\>
```

Note:

<ENTER> stands for keyboard "ENTER " key. In the above example, please press "ENTER " key instead of typing <ENTER> in the above example. <CTRL> stands for keyboard "Ctrl" key.

Troubleshooting:

Press the FEED key to test. Does printer stop at the same position on each label without the error light blinking? If not, adjust the setting to a larger number. When adjusting this setting, begin from 0 and then on to higher values-incrementally.

See Also

SIZE, GAP, BLINE

● SET BLINE

Description

This setting is using to reverse/obverse the sensor function.

Syntax

SET BLINE REVERSE/OBVERSE

<u>Parameter</u>	<u>Description</u>
REVERSE	Reverse the sensor function. Redefine the reflective area is black line and non-reflective part is paper. (Normally, reflective part is paper and non-reflective part is black line.)
OBVERSE	Disable the "SET BLINE REVERSE" function.

● SET HEAD

Description

This setting is used to enable/disable head open sensor. If the head open sensor is turned off, an open printer head will not return an error message. This setting will be saved in printer memory. This command is only available for TSPL2 printers.

Note: Please refer to [printer model list](#) for checking TSPL2 printers.

Syntax

SET HEAD ON /OFF

<u>Parameter</u>	<u>Description</u>
ON	Turn on the "HEAD OPEN " sensor
OFF	Turn off the "HEAD OPEN " sensor

Example

SET HEAD ON
SET HEAD OFF

● SET RIBBON

Description

This setting is used to enable/disable ribbon sensor detection. (Thermal Transfer Printing/Thermal Direct Printing) Printer will detect the presence of a ribbon to determine using either direct thermal or thermal transfer printing upon printer startup. This setting will NOT be saved in printer memory.

Syntax

SET RIBBON ON/OFF/INSIDE/OUTSIDE

<u>Parameter</u>	<u>Description</u>
ON	Thermal transfer printing
OFF	Thermal direct printing
INSIDE	The ribbon is inside wound. For TTP-384M only. <i>*Since V6.80EZ.</i>
OUTSIDE	The ribbon is outside wound. For TTP-384M only. <i>*Since V6.80EZ.</i>

Example

Sample Code

```
REM *****Disable ribbon detection sensor for direct thermal printing.
SET RIBBON OFF
SIZE 4,1
GAP 0,0
CLS
TEXT 10,10, " 3 " ,0,1,1, " Direct thermal printing. "
PRINT 1
```

```
REM *****Enable ribbon detection sensor for thermal transfer printing.
SET RIBBON ON
SIZE 4,1
GAP 0,0
CLS
TEXT 10,10, " 3 " ,0,1,1, " Thermal transfer printing. "
PRINT 1
```

```
REM *****For using ink-in ribbon in TTP-384M.
SET RIBBON INSIDE
SIZE 4,1
GAP 0,0
CLS
TEXT 10,10, " 3 " ,0,1,1, " TTP-384M is using ink-in ribbon. "
PRINT 1
```

```
REM *****For using ink-out ribbon in TTP-384M.
SET RIBBON OUTSIDE
SIZE 4,1
GAP 0,0
CLS
TEXT 10,10, " 3 " ,0,1,1, " TTP-384M is using ink-out ribbon. "
PRINT 1
```

● SET ENCODER

Description

This setting is used to enable/disable ribbon encoder sensor detection.

Syntax

SET ENCODER ON/OFF

<u>Parameter</u>	<u>Description</u>
ON	Enable ribbon encoder sensor.
OFF	Disable ribbon encoder sensor.

Example

SET ENCODER ON

SET ENCODER OFF

● SET RIBBONEND

Description

This setting is used to enable/disable ribbon-end sensor detection.

Syntax

SET RIBBONEND ON/OFF

<u>Parameter</u>	<u>Description</u>
ON	Enable ribbon-end sensor.
OFF	Disable ribbon-end sensor.

Note:
This command has been supported since V6.91 EZ and later firmware.

Example

SET RIBBONEND ON
SET RIBBONEND OFF

● SET COM1

Description

This setting defines communication parameters for printer serial port.

Syntax

SET COM1 baud,parity,data,stop

<u>Parameter</u>	<u>Description</u>
baud	Baud rate, available baud rates are as listed : 24: 2400 bps 48: 4800 bps 96: 9600 bps 19: 19200 bps 38: 38400 bps 57: 57600 bps 115: 115200 bps
parity	Parity check N: No parity check E: Even parity check O: Odd parity check
Data	Data bit 8: 8 bits data 7: 7 bits data
stop	Stop bit 1: 1 stop bit 2: 2 stop bits

Example

The parallel port is used to setup the printer serial port in this example via MS-DOS mode.

```
C:\>COPY CON LPT1<ENTER>  
SET COM1 19,N,8,1<ENTER>  
<CTRL><Z><ENTER>  
C:\>
```

Note:

<ENTER> stands for PC keyboard "ENTER" key. <CTRL><Z> means to hold PC keyboard "CTRL" key then press the PC keyboard <Z> key.

● SET PRINTKEY

Description

This command will print one label and feed label gap to tear bar position for tearing away. Press FEED button to print the next label or batch of labels. If label content includes serial text or barcode, it will change the serial number accordingly. This setting will be saved in printer memory.

Syntax

SET PRINTEKY OFF/ON/AUTO/<num>

<u>Parameter</u>	<u>Description</u>
OFF	Disable this function
ON	Enable this function
AUTO	Enable this function
<num>	Numbers of labels will be printed if FEED button is pressed.

Note: This command is only available for TSPL2 printers. Please refer to [printer model list](#) for checking TSPL2 printers.

Example

Sample code

```
SIZE 4,2.5
GAP 0.12,0
SET PRINTKEY ON
SET COUNTER @0 1
@0= "0001"
CLS
TEXT 10,10, "5",0,1,1,@0
PRINT 1
```

Execute:

Syntax	Receive "PRINT m"	Print Out
SET PRINTKEY ON or SET PRINTKEY AUTO	1.) PRINT 2	Label 1~2
	2.) Press FEED key	Label 3~4

Syntax	Receive "PRINT m,n"	Print Out
SET PRINTKEY ON or SET PRINTKEY AUTO	1.) PRINT 1,2	Label 1, Label 1
	2.) Press FEED key	Label 2, Label 2

Syntax	Receive "PRINT -1,n"	Print Out
SET PRINTKEY ON or SET PRINTKEY AUTO	1.) PRINT -1,2	Label 1, Label 1
	2.) Press FEED key	Label 1, Label 1

Syntax	Receive "PRINT m"	Print Out
SET PRINTKEY 5	1.) PRINT 2	Label 1~2
	2.) Press FEED key	Label 3~7
Syntax	Receive "PRINT m,n"	Print Out
SET PRINTKEY 5	1.) PRINT 1,2	Label 1, Label 1
	2.) Press FEED key	Label 2~6

Syntax	Receive "PRINT -1,n"	Print Out
SET PRINTKEY 5	1.) PRINT -1,2	Label 1, Label 1
	2.) Press FEED key	Label 1, Label 1

● SET REPRINT

Description

This command will disable/enable a reprinting attempt subsequent to a “no paper”, “no ribbon” or “carriage open” error.

Syntax

SET REPRINT OFF/ON

<u>Parameter</u>	<u>Description</u>
OFF	Disable this function
ON	Enable this function

Note: This command is only available for TSPL2 printers. Please refer to [printer model list](#) for checking TSPL2 printers.

Example

SET REPRINT ON

● SET FEED_LEN

Description

This command can set the feeding length when FEED key is pressed. This setting will be memorized by printer. The initialized value is the label length.

Syntax

SET FEED_LEN n

<u>Parameter</u>	<u>Description</u>
n	The feeding length in dot.

Note:
This command has been supported since V5.10 EZ and later firmware.

Example

Sample code SET FEED_LEN 100
Result The feeding length is 100 dots when you press the FEED button after this setting.

● GETSENSOR()

Description

This command is used to get the sensor status/AD value. We can use it to check the sensor function.

Syntax

GETSENSOR(sensor\$[,intension])

<u>Parameter</u>	<u>Description</u>	
sensor\$	Sensor type.	
	GAP	Gap sensor
	BLINE	Black mark sensor
	RIBBON	Ribbon-end sensor
	PEEL	Peeler sensor
	HEAD UP	Thermal print head open sensor
	HEAD TEMP	The temperature of print head
	HEAD VOLT	The voltage of print head
	BATTERY VOLT	The voltage of battery (since A2.05 EZC)
	BATTERY CAP	The capacity of battery (since A2.05 EZC)
intension	Sensor intension.	
	Gap intension	Please refer to SET GAP for gap sensor range of different model.
	BLINE intension	Please refer to SET GAP for black mark sensor range of different model.
	RIBBON intension	0 ~ 3
	PEEL sensor intension	Ignored
	HEAD UP sensor intension	Ignored
	HEAD TEMP	Ignored
	HEAD VOLT	Ignored
Returned value	Gap	Return the AD value of gap sensor
	BLINE	Return the AD value of black mark sensor
	RIBBON	Return the AD value of ribbon sensor
	PEEL	The return value will be either 0 or 1 0: Paper is not on the sensor 1: Paper is on the sensor
	HEAD UP	The return value will be either 0 or 1 0: print head module is close 1: print head module is open
	HEAD TEMP	Return the temperature of thermal print head
	HEAD VOLT	Return the voltage of thermal print head
Note: <i>This command has been supported since V6.75 EZ and later firmware.</i>		

Example (Use CommTool to get sensor status via RS-232.)

Sample code

```
OUT GETSENSOR("GAP",0)
OUT GETSENSOR("GAP",1)
OUT GETSENSOR("GAP",2)
OUT GETSENSOR("GAP",3)
OUT GETSENSOR("GAP",4)
OUT GETSENSOR("GAP",5)
OUT GETSENSOR("GAP",6)
OUT GETSENSOR("GAP",7)
OUT GETSENSOR("GAP",8)
```

Result

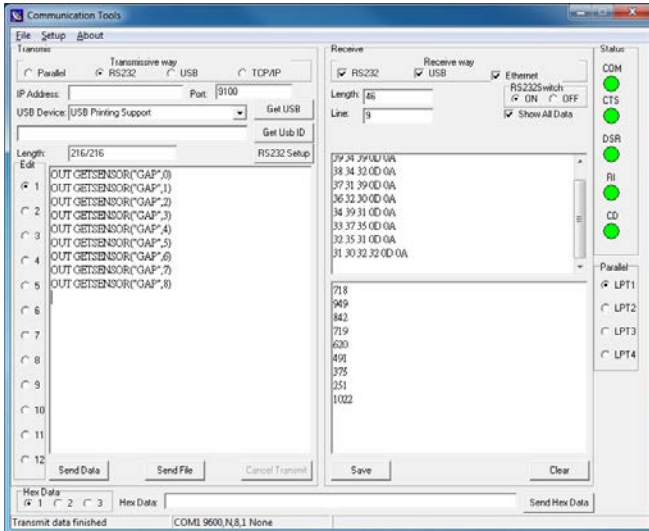

**If the returned valued is changed in different sensor intension, we can say the sensor is functional.*

Sample code

```
OUT GETSENSOR("BLINE",0)
OUT GETSENSOR("BLINE",1)
OUT GETSENSOR("BLINE",2)
OUT GETSENSOR("BLINE",3)
```

Result

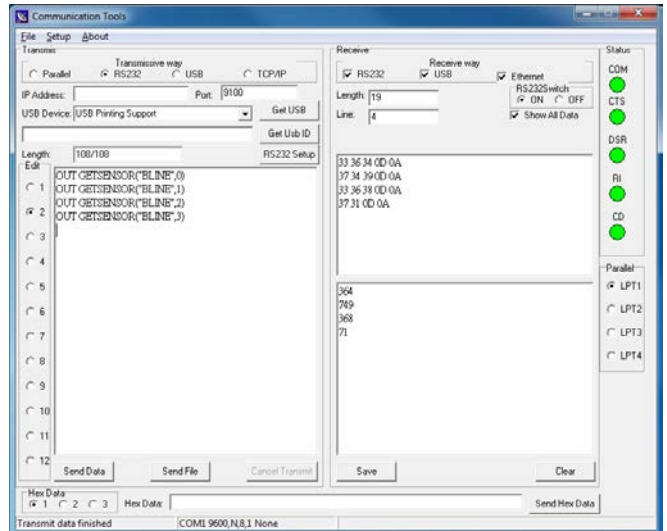

**If the returned valued is changed in different sensor intension, we can say the sensor is functional.*

Sample code

```
OUT GETSENSOR("RIBBON",0)
OUT GETSENSOR("RIBBON",1)
OUT GETSENSOR("RIBBON",2)
OUT GETSENSOR("RIBBON",3)
```

Result

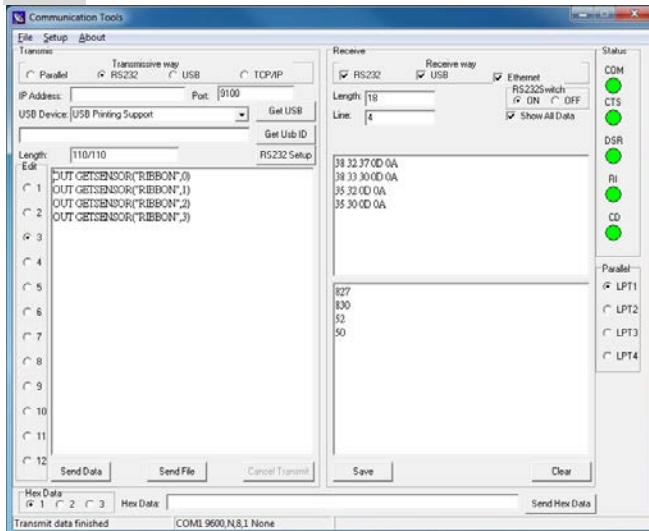

**If the returned valued is changed in different sensor intension, we can say the sensor is functional.*

Sample code

```
OUT GETSENSOR("PEEL")
```

Result

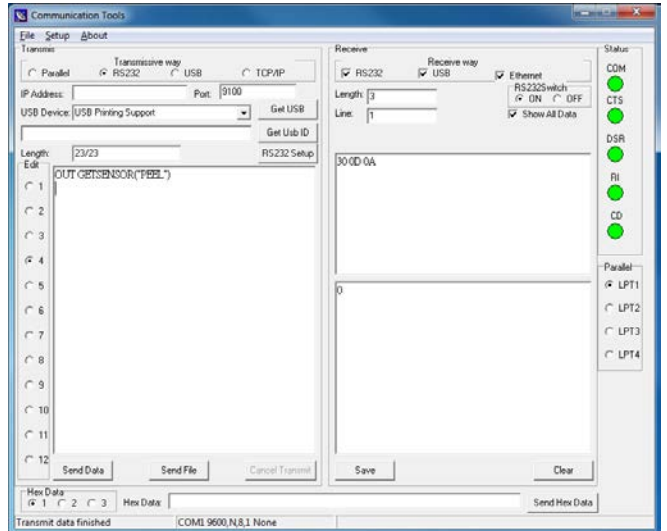

**0: Paper is not on the sensor. 1: Paper is on the sensor.*

Sample code

```
OUT GETSENSOR("BATTERY VOLT")  
OUT GETSENSOR("BATTERY CAP")
```

Result

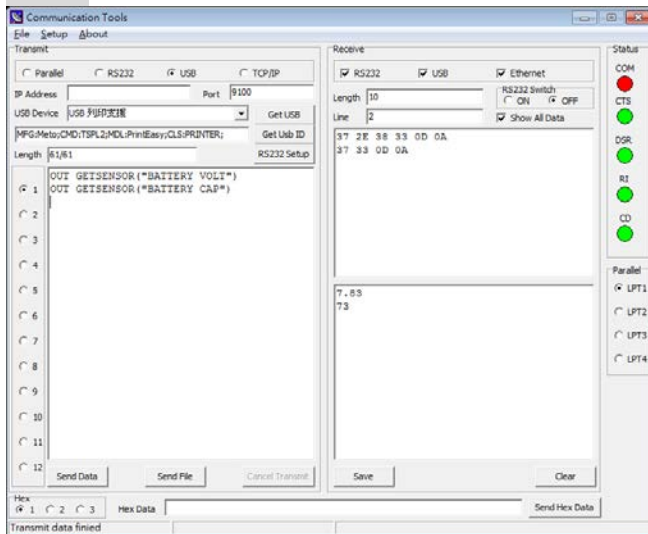

****This code used to detect the battery voltage and battery capacity for mobile Printer since A2.05 EZC and later firmware.***

● GETSETTING\$()

Description

This command is used to get printer settings.

Syntax

GETSETTING\$ (app\$,sec\$,key\$[,default\$])

app\$	sec\$	key\$	Comment	
SYSTEM	INFORMATION	DPI	Return printer resolution	
		MODEL	Return printer model name	
		SERIAL	Return Printer serial number	
		VERSION	Return Printer firmware version	
		CHECKSUM	Return Printer firmware checksum	
	RECORD	MILAGE	Return printed mileage	
		CUT COUNTER	Return cutter cuts	
FILE	DRAM	CAPACITY	Return the total capacity of DRAM	
		AVAILABLE	Return the available capacity of DRAM	
	FLASH	CAPACITY	Return the total capacity of FLASH	
		AVAILABLE	Return the available capacity of FLASH	
	CARD	CAPACITY	Return the total capacity of CARD	
		AVAILABLE	Return the available capacity of CARD	
INSTALLED		Return the status of card. 1: installed; 0: none installed.		
CONFIG	NET	MAC ADDRESS	Return MAC address	
		IP ADDRESS	Return IP address	
		SUBNET MASK	Return Subnet Mask	
		DEFAULT GATEWAY	Return default gateway	
		RAW PORT	Return raw port	
		NAME	Return printer name	
		PRIMARY DNS	Return primary DNS	since V8.12 & A2.09
		SECONDARY DNS	Return secondary DNS	
	WLAN	MAC ADDRESS	Return MAC address	
		IP ADDRESS	Return IP address	
		SUBNET MASK	Return Subnet Mask	
		DEFAULT GATEWAY	Return default gateway	
		RAW PORT	Return raw port	
	COM1	BAUD RATE	Return baud rate of COM port	
		DATA BIT	Return data bit of COM port	
		PARITY	Return parity of COM port	
		STOP BIT	Return stop bit of COM port	
	SENSOR	SENSOR TYPE	Return the current sensor type	
		CARRIAGE	Return the status of head open sensor.	
		GAP INTENSION	Return intension of gap sensor.	
		BLINE INTENSION	Return intension of black mark sensor.	
		CONTINUOUS INTENSION	Return intension of continuous sensor.	
	TSPL	PRINT MODE	Return pos-print action.	
		DENSITY	Return print density	
		PAPER SIZE	Return paper size	
		GAP SIZE	Return gap size	
		BLINE SIZE	Return black mark size	
		DIRECTION	Return printing direction	
		MIRROR	Return mirror status.	
		RIBBON	Return ribbon status.	
REPRINT		Return reprint status.		
PAPER WIDTH		Return paper width		
LIMIT FEED		Return maximum length for sensor calibration.		
OFFSET		Return OFFSET value.		
REFERENCE X		Return REFERENCE X value.		
REFERENCE Y		Return REFERENCE Y value.		
SHIFT X		Return SHIFT X value.		
SHIFT Y		Return SHIFT Y value.		
SPEED		Return print speed.		
COUNTRY CODE	Return COUNTRY code.			
CODEPAGE	Return CODEPAGE.			

<u>Parameter</u>	<u>Description</u>
default\$	Optional. Expression containing the value to return if no value is set in the key\$ setting. If omitted, default is assumed to be a zero-length string ("").

Note: This command has been supported since V6.72 EZ and later firmware.

Example

Sample code (Use CommTool to get printer settings via RS-232.)

```

OUT "DPI = ";GETSETTING$("SYSTEM","INFORMATION","DPI")
OUT " MODEL =";GETSETTING$("SYSTEM", " INFORMATION ", " MODEL")
OUT "SERIAL = ";GETSETTING$("SYSTEM","INFORMATION","SERIAL")
OUT "VERSION = ";GETSETTING$("SYSTEM", "INFORMATION", "VERSION")
OUT "CHECKSUM = ";GETSETTING$("SYSTEM","INFORMATION","CHECKSUM")
OUT "MILAGE = ";GETSETTING$("SYSTEM", "RECORD", "MILAGE")
OUT "CUT COUNTER = ";GETSETTING$("SYSTEM","RECORD","CUT COUNTER")
OUT "DRAM CAPACITY = ";GETSETTING$("FILE", "DRAM", "CAPACITY")
OUT "DRAM AVAILABLE = ";GETSETTING$("FILE", "DRAM", "AVAILABLE")
OUT "FLASH CAPACITY = ";GETSETTING$("FILE", "FLASH", "CAPACITY")
OUT "FLASH AVAILABLE = ";GETSETTING$("FILE", "FLASH", "AVAILABLE")
OUT "CARD CAPACITY = ";GETSETTING$("FILE", "CARD", "CAPACITY")
OUT "CARD AVAILABLE = ";GETSETTING$("FILE", "CARD", "AVAILABLE")
OUT "CARD INSTALLED = ";GETSETTING$("FILE", "CARD", "INSTALLED")
OUT "Ethernet MAC ADDRESS = ";GETSETTING$("CONFIG", "NET", "MAC ADDRESS")
OUT "Ethernet IP ADDRESS = ";GETSETTING$("CONFIG", "NET", "IP ADDRESS")
OUT "Ethernet SUBNET MASK = ";GETSETTING$("CONFIG", "NET", "SUBNET MASK")
OUT "Ethernet DEFAULT GATEWAY = ";GETSETTING$("CONFIG","NET","DEFAULT GATEWAY")
OUT "Ethernet PRIMARY DNS = ";GETSETTING$("CONFIG","NET","PRIMARY DNS")
OUT "Ethernet SECONDARY DNS = ";GETSETTING$("CONFIG","NET","SECONDARY DNS")
OUT "COM1 BAUD RATE = ";GETSETTING$("CONFIG", "COM1", "BAUD RATE")
OUT "COM1 DATA BIT = ";GETSETTING$("CONFIG","COM1","DATA BIT")
OUT "COM1 PARITY = ";GETSETTING$("CONFIG", "COM1", "PARITY")
OUT "COM1 STOP BIT = ";GETSETTING$("CONFIG", "COM1", "STOP BIT")
OUT "SENSOR TYPE = ";GETSETTING$("CONFIG","SENSOR","SENSOR TYPE")
OUT "CARRIAGE = ";GETSETTING$("CONFIG", "SENSOR", "CARRIAGE")
OUT "GAP INTENSION = ";GETSETTING$("CONFIG","SENSOR","GAP INTENSION")
OUT "BLINE INTENSION = ";GETSETTING$("CONFIG", "SENSOR", "BLINE INTENSION")
OUT "CONTINUOUS INTENSION = ";GETSETTING$("CONFIG","SENSOR","CONTINUOUS INTENSION")
OUT "PRINT MODE = ";GETSETTING$("CONFIG", "TSPL", "PRINT MODE")
OUT "DENSITY = ";GETSETTING$("CONFIG","TSPL","DENSITY")
OUT "PAPER SIZE = ";GETSETTING$("CONFIG", "TSPL", "PAPER SIZE")
OUT "GAP SIZE = ";GETSETTING$("CONFIG", "TSPL", "GAP SIZE")
OUT "BLINE SIZE = ";GETSETTING$("CONFIG", "TSPL", "BLINE SIZE")
OUT "DIRECTION = ";GETSETTING$("CONFIG","TSPL","DIRECTION")
OUT "MIRROR = ";GETSETTING$("CONFIG","TSPL","MIRROR")
OUT "RIBBON = ";GETSETTING$("CONFIG", "TSPL", "RIBBON")
OUT "REPRINT = ";GETSETTING$("CONFIG","TSPL","REPRINT")
OUT "PAPER WIDTH = ";GETSETTING$("CONFIG", "TSPL", "PAPER WIDTH")
OUT "LIMIT FEED = ";GETSETTING$("CONFIG","TSPL","LIMIT FEED")
OUT "OFFSET = ";GETSETTING$("CONFIG","TSPL","OFFSET")
OUT "REFERENCE X = ";GETSETTING$("CONFIG", "TSPL", "REFERENCE X")
OUT "REFERENCE Y = ";GETSETTING$("CONFIG","TSPL","REFERENCE Y")
OUT "SHIFT X = ";GETSETTING$("CONFIG", "TSPL", "SHIFT X")
OUT "SHIFT Y = ";GETSETTING$("CONFIG","TSPL","SHIFT Y")
OUT "SPEED = ";GETSETTING$("CONFIG", "TSPL", "SPEED")

```

OUT "COUNTRY CODE = ";GETSETTING\$("CONFIG","TSPL","COUNTRY CODE")
 OUT "CODEPAGE = ";GETSETTING\$("CONFIG","TSPL","CODEPAGE")

Result

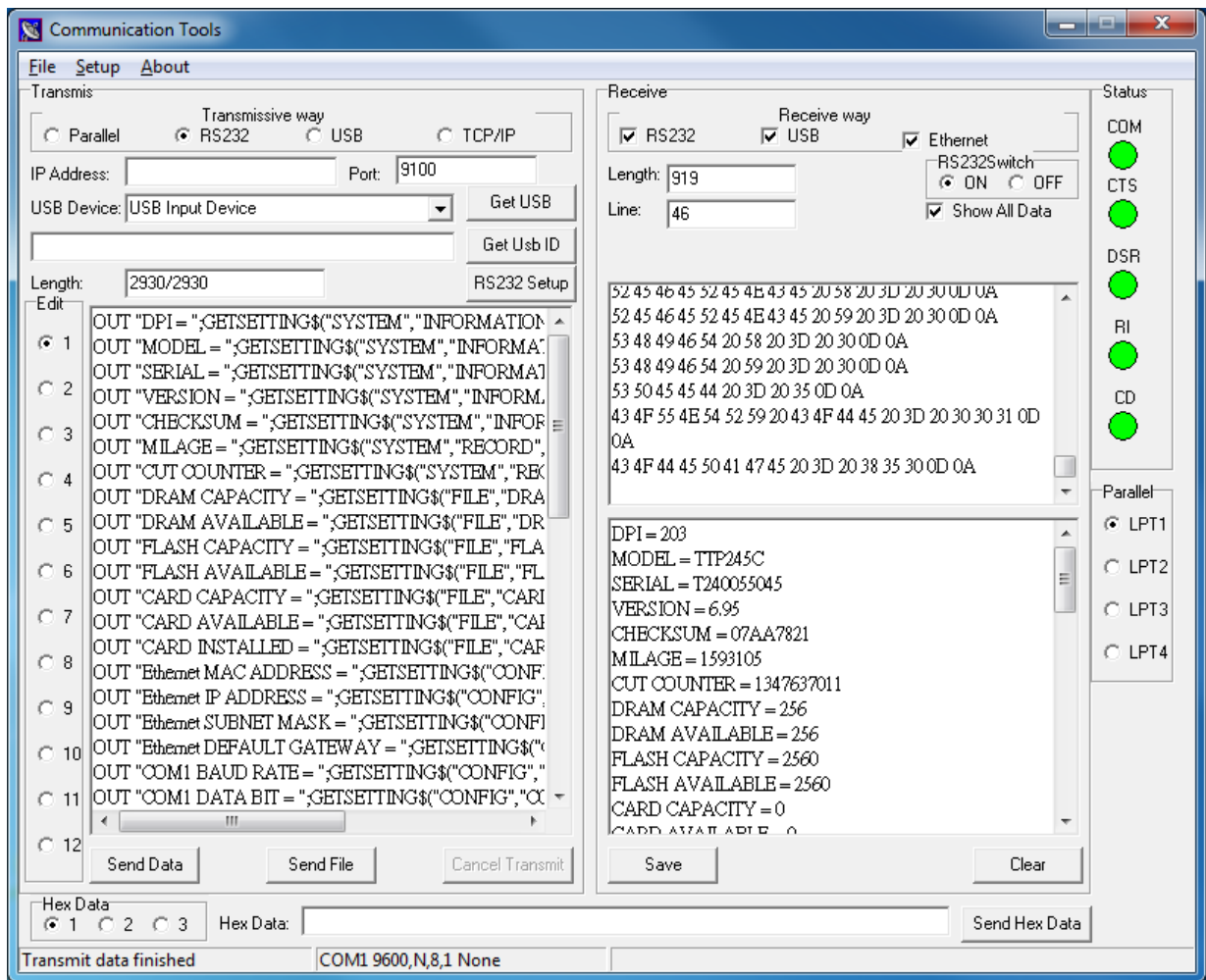

Sample code(NET, WLAN)

OUT "Ethernet DEFAULT RAW PORT = ";GETSETTING\$("CONFIG","NET","RAW PORT")

OUT "WLAN MAC ADDRESS = ";GETSETTING\$("CONFIG","WLAN","MAC ADDRESS")

OUT "WLAN IP ADDRESS = ";GETSETTING\$("CONFIG","WLAN","IP ADDRESS")

OUT "WLAN SUBNET MASK = ";GETSETTING\$("CONFIG","WLAN","SUBNET MASK")

OUT "WLAN DEFAULT GATEWAY = ";GETSETTING\$("CONFIG","WLAN","DEFAULT GATEWAY")

OUT "WLAN DEFAULT RAW PORT = ";GETSETTING\$("CONFIG","WLAN","RAW PORT")

OUT "NET Name = ";GETSETTING\$("CONFIG","NET","NAME")

● SET USBHOST

Description

This command can set the USB host for the usage of USB keyboard or scanner.

Syntax

SET USBHOST KEYBOARD/SCANNER

<u>Parameter</u>	<u>Description</u>
KEYBOARD	USB keyboard (Enable the prompt shown on LCD)
SCANNER	USB scanner (Disable the prompt shown on LCD)

Note:

- *This command has been supported since V6.95 EZ and later firmware.*
- *This command is for the model which has USB HOST connector.*

Example

Sample code

```
SET USBHOST KEYBOARD
DOWNLOAD "A.BAS "
LOOP:
SIZE 4,2
GAP 0,0
CLS
INPUT A$
TEXT 50,50, "0 ",0,20,20,A$
PRINT 1
GOTO LOOP
EOP
A.BAS
```

● SET RS232_REWINDER

Description

This command is used to set the CTS (PIN8) control signal to High or Low status via RS-232 port for external rewind module application.

Syntax

```
SET RS232_REWINDER "RASING"/ "FALLING"/ "OFF"
```

Parameter	Description
"RASING"	Set high level signal status while printer is printing
"FALLING"	Set low level signal status while printer is printing
"OFF "	Disable this function (Default)

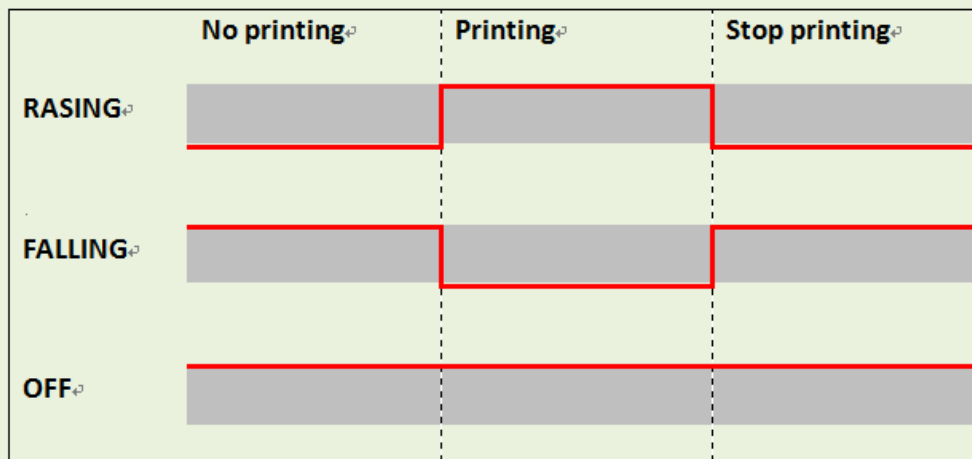

Note:

- This command has been supported since V8.01 EZ & A1.85 EZ and later firmware.
- This command is for the model which has RS-232 connector.

Example

Sample code

```
SET RS232_REWINDER "RASING"
```

● SET AUTORUN

Description

This command redefines the BAS file which can be run automatically while switching on the printer. Default is AUTO.BAS.

Syntax

SET AUTORUN "filename"

<u>Parameter</u>	<u>Description</u>
filename	The file will be defined to AUTO-RUN file. Default is AUTO.BAS.
Note: <i>This command has been supported since V6.86 EZ and later firmware.</i>	

Example

<u>Sample Code</u>
<pre>REM *****Step1: Send the following command to redefine the auto-run file from "AUTO.BAS" to "TEST.BAS" SET AUTORUN "TEST.BAS" REM *****Step2: Send the following commands to download "TEST.BAS" file into printer. DOWNLOAD F, "TEST.BAS" SIZE 4,1 GAP 0,0 DIRECTION 1 CLS BLOCK 10,10,600,200, "3",0,1,1,12, "[]TEST.BAS\[] is running automatically while turning on the printer. " PRINT 1 EOP REM *****Step3: Turn off and on the printer to run "TEST.BAS" automatically.</pre>
<u>Result</u>
<pre>"TEST.BAS" is running automatically while turning on the printer.</pre>

● SET VERIFIER

Description

This command is used to add a data at start printing or end printing then return it via RS-232 port for verifier (scanner) application.

Syntax

SET VERIFIER ON/OFF

VERIFYTRIGGER CHR\$()+CHR\$()...

VERIFYEND CHR\$()+CHR\$()...

Parameter	Description
ON	Enable verifier function
OFF	Disable verifier function
VERIFYTRIGGER	Add data at start printing
VERIFYEND	Add data at end printing

Note:
This command has been supported since V6.92 EZ and later firmware.

Example

Sample Code

SET VERIFIER ON

VERIFYTRIGGER CHR\$(48)+CHR\$(49)+CHR\$(50)

VERIFYEND CHR\$(65)+CHR\$(66)+CHR\$(67)

PRINT 10

Result

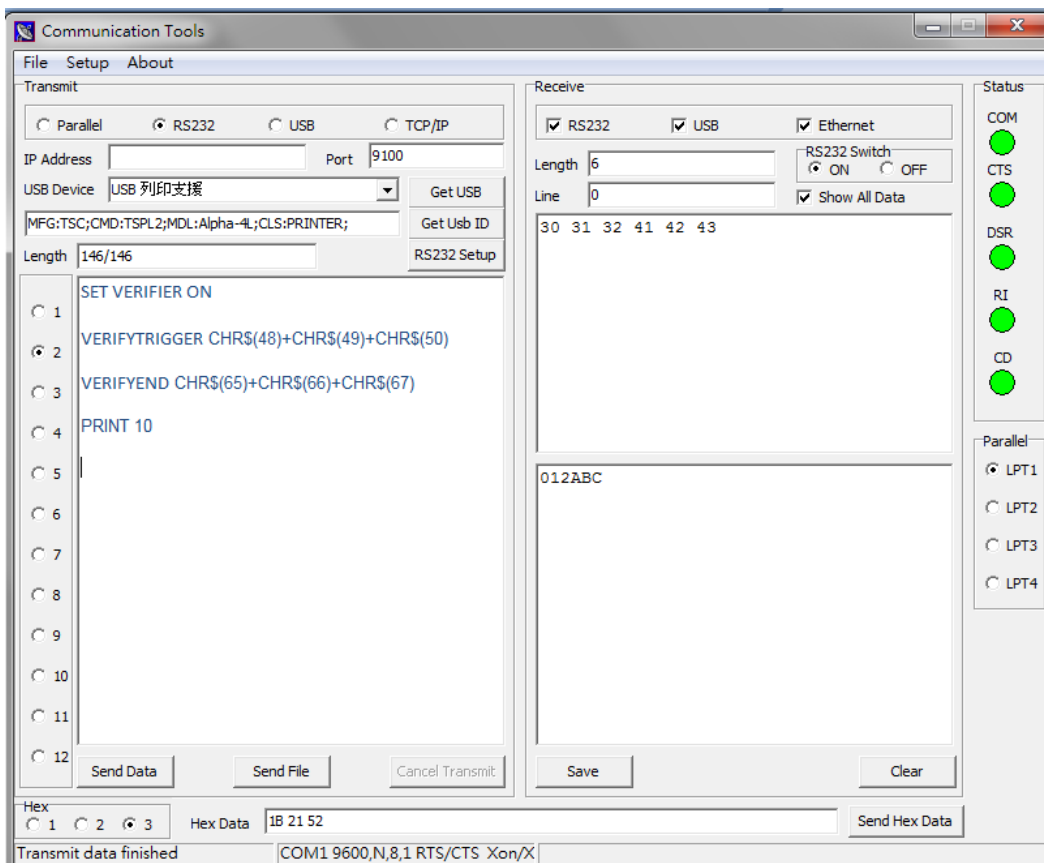

● SET RESPONSE

Description

This command can response issue automatically.

Syntax

SET RESPONSE ["Job ID",] ON/OFF/BATCH

<u>Parameter</u>	<u>Description</u>
["Job ID"]	Optional. Set job ID. Default is Null
ON	Enable this function
OFF	Disable this function. Default is OFF
BATCH	Response at the end of printing job

Note:
This command has been supported since V7.09 EZ and later firmware.

Response Syntax

{Status,#####,ID}

<u>Status</u>
[Hex Receive]
00 Normal
01 Head opened
02 Paper Jam
03 Paper Jam and head opened
04 Out of paper
05 Out of paper and head opened
08 Out of ribbon
09 Out of ribbon and head opened
0A Out of ribbon and paper jam
0B Out of ribbon, paper jam and head opened
0C Out of ribbon and out of paper
0D Out of ribbon, out of paper and head opened
10 Pause
20 Printing
80 Other error
#####: 00001 ~ 99999

Example

<u>Sample Code</u>
<pre>SET RESPONSE ON SIZE 4,2 GAP 0,0 PRINT 3 {00,00001}{00,00002}{00,00003}</pre>

Sample Code

SET RESPONSE "ID1",ON
SIZE 4,2
GAP 0,0
PRINT 3,2

{00,00001,ID1}{00,00002,ID1}{00,00003,ID1}{00,00004,ID1}{00,00005,ID1}{00,00006,ID1}

Sample Code

SET RESPONSE "CCCC ",BATCH
SIZE 4,2
GAP 0,0
PRINT 3,2

{00,00006,CCCC}

● SET DAYLIGHT_SAVE

Description

This command is used to set daylight saving time.

Syntax

SET DAYLIGHT_SAVE ON/OFF

SET DAYLIGHT_SAVE "Start", "End"

<u>Paramet</u>	<u>Description</u>
<u>er</u>	
ON	Enable function
OFF	Disable function (Default)
"Start"	The time will be increased 1 hour from "Start time"
"End"	The time will be reduced 1 hour (return) from "End time"
	Month
	"JAN", "FEB", "MAR", "APR", "MAY", "JUN", "JUL", "AUG", "SEP", "OCT", "NOV", "DEC" "JANUARY", "FEBRUARY", "MARCH", "APRIL", "MAY", "JUNE", "JULY", "AUGUST", "SEPTEMBER", "OCTOBER", "NOVEMBER", "DECEMBER"
	Week
	"SUN", "MON", "TUE", "WED", "THU", "FRI", "SAT" "SUNDAY", "MONDAY", "TUESDAY", "WEDNESDAY", "THURSDAY", "FRIDAY", "SATURDAY"
	Which Week
	"FIRST", "SECOND", "THIRD", "FOURTH", "LAST" "1 ST ", "2 ND ", "3 RD ", "4 TH ", "LAST"
	Date
	1~31
	Time
	0:00~23:00
Note:	<i>This command has been supported since V8.03 EZ and later firmware.</i>

Example

Sample Code

```
SET DAYLIGHT_SAVE ON
SET DAYLIGHT_SAVE OFF
SET DAYLIGHT_SAVE "MAR 1 4:00", "NOV 1 5:00"
SET DAYLIGHT_SAVE "MAR FIRST SUN 2:00", "NOV LAST SUN 3:00"
```

● PEEL

Description

This command obtains the status of the peel-off sensor. This attribute is read only.

Syntax

PEEL

<u>Return Value</u>	<u>Description</u>
0	Paper is not on top of peel sensor
1	Paper is on top of peel sensor

Example

Sample code

```
DOWNLOAD "DEMO.BAS"
SIZE 4,1
GAP 0,0
SET PEEL OFF
SET KEY1 OFF
SET LED1 OFF
SET LED3 OFF
:START
LED1=0
LED3=0
IF KEY1=1 THEN GOTO A
GOTO START
:A
LED1=1
CLS
TEXT 10,10, "3",0,1,1, "PEEL Function Test!! "
PRINT 1,1
:B
LED1=0
IF PEEL=1 THEN
LED3=1
GOTO B
ELSE
CLS
TEXT 10,10, "3",0,1,1, "The label is removed from the PEEL sensor!! "
PRINT 1,1
GOTO START
ENDIF
EOP
DEMO
```

● LED1, LED2, LED3

Description

This command is used to control LED on/off. This attribute is write-only. Specify 1 to light on LED and 0 to turn off LED. Before using this command, be sure to cancel the default LED functions. Please refer to the SET LED command.

Syntax

LEDm = n

<u>Return Value</u>	<u>Description</u>									
m	m=1, LED1 m=2, LED2 m=3, LED3									
n	0: turn off LED 1: light on LED									
		Model	LED1	LED2	LED3	LED4	LED5	LED6	LED7	LED2 & LED3
		TDP-643 Plus/ 643R Plus series	ONLINE	ERROR	ERROR					
		TTP-243/243 Plus/243 Pro series, TTP-244ME/244 ME Plus/244M Pro series, TTP-244/ 244 Plus series TTP-2410M/2410M Pro series, TTP-246M Plus/246M Pro series, TTP-268M series, TTP-384M series, ME240 series, MX240 series, MX240P series	POWER	ONLINE	ERROR					
		TDP-245/247 series, TTP-245/247 series, TTP-245C series, TDP-225 series, TTP-225 series, DA200 series, TA200 series, TC210series, TE200 series, MH series Note: For this series, the LED1=LED2	GREEN	GREEN	RED					ORANGE
		Alpha-2R series , Alpha-3R series	GREEN	RED	BAT1	BAT2	BAT3	BT/WIFI		ORANGE
		Alpha-4L series	GREEN	RED	BAT1	BAT2	BAT3	BT	WIFI	ORANGE

Note: Please refer to [printer model list](#) for checking series printers.

Example

```

Sample code
DOWNLOAD "DEMO.BAS"
SIZE 3,3
GAP 0.12,0
SPEED 4
DENSITY 8
DIRECTION 1
REFERENCE 0,0
SET CUTTER OFF
SET PEEL OFF
SET LED1 OFF
SET LED2 OFF
SET LED3 OFF
LED1=0
LED2=1
LED3=0
EOP

```

DEMO

● KEY1, KEY2, KEY3

Description

This command reads the status of KEY1, KEY2 and KEY3.

Model	KEY0	KEY1	KEY2	KEY3	KEY4	KEY5	KEY6
TDP-643 Plus/ 643R Plus		PAUSE					
TTP-243/243 Plus/243 Pro series, TTP-244ME/244 ME Plus/244M Pro series, TTP-244/244 Plus series		PAUSE	FEED				
TDP-245/247 series, TTP-245/247 series, TTP-245C series, TDP-225 series, TTP-225 series, TA200 series, Alpha-3R, DA series, TE series, Alpha-2R		FEED					
TX200 series (with LCD), TC210 series (with LCD), TX600 series, MX240P series, MH series		FEED	MENU	UP	RIGHT	LEFT	DOWN
TTP-246M series		MENU	PAUSE	FEED	(UP)	(DOWN)	(SELECT)
TTP-248M series		MENU	PAUSE	FEED			
TTP-2410M/2410M Pro series, TTP-246M Plus/246M Pro series, TTP-268M series, TTP-384M series, ME240(LCD control panel) series		MENU	PAUSE	FEED	UP	DOWN	SELECT
ME240 (Non-LCD control panel) series		FEED	PAUSE				
M23 series	FEED	LEFT	MID	RIGHT			
Alpha-4L		FEED	INFO	MENU			
MX240 series, TTP-2410MT/MU series		PAUSE	MENU	FEED	UP	SELECT	DOWN

Note: Please refer to [printer model list](#) for checking series printers.

Syntax

KEYm = n

Key	Return Value
KEY1 (MENU)	0: released 1: pressed
KEY2 (PAUDE)	0: released 1: pressed
KEY3 (FEED)	0: released 1: pressed

Example

```

Sample code

DOWNLOAD "DEMO.BAS"
SIZE 3,1
GAP 0,0
SPEED 4
DENSITY 8
DIRECTION 1
REFERENCE 0,0

```

```
SET LED1 OFF
SET KEY1 OFF
LED1=0
:START
IF KEY1=1 THEN
LED1=1
CLS
TEXT 100,10, "3",0,1,1, "KEY FUNCTION TEST"
PRINT 1,1
ELSE
LED1=0
ENDIF
GOTO START
EOP
DEMO
```

Printer Global Variables

● @LABEL

Description

This variable counts how many pieces of labels have been printed. This attribute cannot be initialized if the printer is reset, but will be retained if the printer power is turned off.

Syntax

Write attribute: @LABEL=n or @LABEL= "n"

Read attribute: A=LABEL or A\$=STR\$(LABEL)

<u>Parameter</u>	<u>Description</u>
n	Number of labels printed. 0<=n<=999999999

Example

<u>Sample code</u>	<u>Result</u>
<pre>DOWNLOAD "DEMO.BAS" SIZE 4,2.5 GAP 0,0 DIRECTION 1 CLS TEXT 10,50, "3",0,1,1,@LABEL TEXT 10,100, "3",0,1,1, "@LABEL="+STR\$(LABEL) TEXT 10,150, "3",0,1,1, "*****Statement 1*****" IF LABEL>1000 THEN TEXT 10,200, "3",0,1,1, "LABEL>1000" ELSE TEXT 10,200, "3",0,1,1, "LABEL<1000" ENDIF TEXT 10,250, "3",0,1,1, "*****Statement 1*****" A=LABEL IF A>1000 THEN TEXT 10,300, "3",0,1,1, "A>1000" ELSE TEXT 10,300, "3",0,1,1, "A<1000" ENDIF TEXT 10,350, "3",0,1,1, "*****Statement 3*****" A\$=STR\$(LABEL) IF VAL(A\$)>1000 THEN TEXT 10,400, "3",0,1,1, "VAL(A\$)>1000" ELSE TEXT 10,400, "3",0,1,1, "VAL(A\$)<1000" ENDIF PRINT 1,1 EOP DEMO</pre>	<pre>1661 @LABEL=1661 *****Statement 1***** LABEL>1000 *****Statement 1***** A>1000 *****Statement 3***** VAL(A\$)>1000</pre>

● YEAR

Description

This variable reads/writes the year data via the Real Time Clock (RTC). Four-digit year formats are supported by RTC.

Syntax

Write attribute: YEAR = 02

Read attribute: A = YEAR

Range: 00~50 = 2000~2050; 51~99 = 1951~1999

Example

Sample code

```
DOWNLOAD "SetYear.BAS"  
REM *****Set Year Parameter to RTC*****  
YEAR=13  
EOP  
SetYear
```

Sample code

```
DOWNLOAD "DEMO.BAS"  
SIZE 4,1  
GAP 0,0  
DIRECTION 1  
CLS  
  
REM *****Read YEAR parameter from RTC*****  
YEAR$=STR$(YEAR)  
Y=YEAR  
  
REM *****Print*****  
TEXT 10,10, "3",0,1,1, "YEAR1="+YEAR$  
TEXT 10,50, "3",0,1,1, "YEAR2="+STR$(Y)  
TEXT 10,90, "3",0,1,1, "YEAR3="+STR$(YEAR)  
PRINT 1  
EOP  
DEMO
```

Result

```
YEAR1=2013  
YEAR2=2013  
YEAR3=2013
```

See Also

~!C, MONTH, DATE, DAY, HOUR, MINUTE, SECOND

● MONTH

Description

This variable reads/writes the month data via the Real Time Clock (RTC). Two-digit (01~12) month formats are supported by RTC.

Syntax

Write attribute: MONTH = 01

Read attribute: A = MONTH

Range: 01~12

Example

Sample code

```
DOWNLOAD "SetMonth.BAS"  
REM *****Set Month Parameter to RTC*****  
MONTH=01  
EOP  
SetMonth
```

Sample code

```
DOWNLOAD "DEMO.BAS"  
SIZE 4,1  
GAP 0,0  
DIRECTION 1  
CLS  
  
REM *****Read Month parameter form RTC*****  
MONTH$=STR$(MONTH)  
M=MONTH  
  
REM *****Print*****  
TEXT 10,10, "3",0,1,1, "MONTH1="+MONTH$  
TEXT 10,50, "3",0,1,1, "MONTH2="+STR$(M)  
TEXT 10,90, "3",0,1,1, "MONTH3="+STR$(MONTH)  
PRINT 1  
EOP  
DEMO
```

Result

```
MONTH1=1  
MONTH2=1  
MONTH3=1
```

See Also

~!C, MONTH, DATE, DAY, HOUR, MINUTE, SECOND

● DATE

Description

This variable reads/writes the date data via the Real Time Clock (RTC). Two-digit (01~31) date formats are supported by RTC.

Syntax

Write attribute: DATE = 12

Read attribute: A = DATE

Range: 01~31

Example

Sample code

```
DOWNLOAD "SetDate.BAS"  
REM *****Set Date Parameter to RTC*****  
DATE=10  
EOP  
SetDate
```

Sample code

```
DOWNLOAD "DEMO.BAS"  
SIZE 4,1  
GAP 0,0  
DIRECTION 1  
CLS  
  
REM *****Read Date parameter form RTC*****  
DATE$=STR$(DATE)  
D=DATE  
  
REM *****Print*****  
TEXT 10,10, "3",0,1,1, "DATE1="+DATE$  
TEXT 10,50, "3",0,1,1, "DATE2="+STR$(D)  
TEXT 10,90, "3",0,1,1, "DATE3="+STR$(DATE)  
PRINT 1  
EOP  
DEMO
```

Result

```
DATE1=10  
DATE2=10  
DATE3=10
```

See Also

~!C, MONTH, DATE, DAY, HOUR, MINUTE, SECOND

● WEEK

Description

This variable reads/writes the day of the week data via the Real Time Clock (RTC), which is represented by one single digit (1~7).

Syntax

Read attribute: A = WEEK

Range: 1(Sunday)~7(Saturday)

Example

Sample code

```
DOWNLOAD "DEMO.BAS "  
SIZE 4,1  
GAP 0,0  
DIRECTION 1  
CLS  
  
REM *****Read Week parameter form RTC*****  
WEEK$=STR$(WEEK)  
W=WEEK  
  
REM *****Print*****  
TEXT 10,10, "3",0,1,1, "WEEK1="+WEEK$  
TEXT 10,50, "3",0,1,1, "WEEK2="+STR$(W)  
TEXT 10,90, "3",0,1,1, "WEEK3="+STR$(WEEK)  
PRINT 1  
EOP  
DEMO
```

Result

```
WEEK1=5  
WEEK2=5  
WEEK3=5
```

See Also

~!C, MONTH, DATE, DAY, HOUR, MINUTE, SECOND

● HOUR

Description

This variable reads/writes the hour data via the Real Time Clock (RTC). The 24-hour-day system (00~23) is supported by RTC.

Syntax

Write attribute: HOUR = 12

Read attribute: A = HOUR

Range: 00~23

Example

Sample code

```
DOWNLOAD "SetHour.BAS"  
REM *****Set Hour Parameter to RTC*****  
HOUR=10  
EOP  
SetHour
```

Sample code

```
DOWNLOAD "DEMO.BAS"  
SIZE 4,1  
GAP 0,0  
DIRECTION 1  
CLS  
  
REM *****Read Hour parameter form RTC*****  
HOUR$=STR$(HOUR)  
H=HOUR  
  
REM *****Print*****  
TEXT 10,10, "3",0,1,1, "HOUR1="+HOUR$  
TEXT 10,50, "3",0,1,1, "HOUR2="+STR$(H)  
TEXT 10,90, "3",0,1,1, "HOUR3="+STR$(HOUR)  
PRINT 1  
EOP  
DEMO
```

Result

```
HOUR1=10  
HOUR2=10  
HOUR3=10
```

See Also

~!C, MONTH, DATE, DAY, HOUR, MINUTE, SECOND

● MINUTE

Description

This variable reads/writes the minute data via the Real Time Clock (RTC). Two-digits (00~59) minute format is supported by RTC.

Syntax

Write attribute: MINUTE = 12

Read attribute: A = MINUTE

Range: 00~59

Example

Sample code

```
DOWNLOAD "SetMinute.BAS"  
REM *****Set Minute Parameter to RTC*****  
MINUTE=27  
EOP  
SetMinute
```

Sample code

```
DOWNLOAD "DEMO.BAS"  
SIZE 4,1  
GAP 0,0  
DIRECTION 1  
CLS  
  
REM *****Read Minute parameter form RTC*****  
MINUTE$=STR$(MINUTE)  
MIN=MINUTE  
  
REM *****Print*****  
TEXT 10,10, "3",0,1,1, "MINUTE1="+MINUTE$  
TEXT 10,50, "3",0,1,1, "MINUTE2="+STR$(MIN)  
TEXT 10,90, "3",0,1,1, "MINUTE3="+STR$(MINUTE)  
PRINT 1  
EOP  
DEMO
```

Result

```
MINUTE1=27  
MINUTE2=27  
MINUTE3=27
```

See Also

~!C, MONTH, DATE, DAY, HOUR, MINUTE, SECOND

● SECOND

Description

This variable reads/writes the second data via the Real Time Clock (RTC). Two-digits (00~59) second format is supported by RTC.

Syntax

Write attribute: **SECOND = 12**

Read attribute: **A = SECOND**

Range: 00~59

Example

Sample code

```
DOWNLOAD "SetSecond.BAS"  
REM *****Set Second Parameter to RTC*****  
SECOND=59  
EOP  
SetSecond
```

Sample code

```
DOWNLOAD "DEMO.BAS "  
SIZE 4,1  
GAP 0,0  
DIRECTION 1  
CLS  
  
REM *****Read Second parameter form RTC*****  
SECOND$=STR$(SECOND)  
SEC=SECOND  
  
REM *****Print*****  
TEXT 10,10, "3",0,1,1, "SECOND1="+SECOND$  
TEXT 10,50, "3",0,1,1, "SECOND2="+STR$(SEC)  
TEXT 10,90, "3",0,1,1, "SECOND3="+STR$(SECOND)  
PRINT 1  
EOP  
DEMO
```

Result

```
SECOND1=59  
SECOND2=59  
SECOND3=59
```

See Also

~!C, MONTH, DATE, DAY, HOUR, MINUTE, SECOND

● @YEAR

Description

This variable reads/writes the year data via the Real Time Clock (RTC). Two-digit year formats are supported by RTC. @YEAR global variable can be accessed directly without using BASIC language functions.

Syntax

Write attribute: @YEAR = "01"

Read attribute: @YEAR

Range: 00~99

Note: This command is only available for TSPL2 printers. Please refer to [printer model list](#) for checking TSPL2 printers.

Example

Sample code	Result
<pre>REM *****Set @YEAR***** @YEAR="05" REM *****Print***** SIZE 4,1 GAP 0,0 DIRECTION 1 CLS TEXT 10,10, "3",0,1,1, "@YEAR" TEXT 210,10, "3",0,1,1, @YEAR PRINT 1</pre>	<pre>@YEAR 2005</pre>

See Also

~!C, @MONTH, @DATE, @DAY, @HOUR, @MINUTE, @SECOND

● @MONTH

Description

This variable reads/writes the month data via the Real Time Clock (RTC). Two-digits (01~12) month formats are supported by RTC. @MONTH global variable can be accessed directly without using BASIC language functions.

Syntax

Write attribute: @MONTH = "01"

Read attribute: @MONTH

Range: 01~12

Note: This command is only available for TSPL2 printers. Please refer to [printer model list](#) for checking TSPL2 printers.

Example

Sample code	Result
<pre>REM *****Set @MONTH***** @MONTH="12" REM *****Print***** SIZE 4,1 GAP 0,0 DIRECTION 1 CLS TEXT 10,10, "3",0,1,1, "@MONTH" TEXT 210,10, "3",0,1,1,@MONTH PRINT 1</pre>	<pre>@MONTH 12</pre>

See Also

~!C, @YEAR, @DATE, @DAY, @HOUR, @MINUTE, @SECOND

● @DATE

Description

This variable reads/writes the date data via the Real Time Clock (RTC). Two-digits (01~31) date formats are supported by RTC. @DATE global variable can be accessed directly without using BASIC language functions.

Syntax

Write attribute: @DATE = "12"

Read attribute: @DATE

Range: 01~31

Note: This command is only available for TSPL2 printers. Please refer to [printer model list](#) for checking TSPL2 printers.

Example

Sample code	Result
<pre>REM *****Set @DATE***** @DATE="31" REM *****Print***** SIZE 4,1 GAP 0,0 DIRECTION 1 CLS TEXT 10,10, "3",0,1,1, "@DATE" TEXT 210,10, "3",0,1,1,@DATE PRINT 1</pre>	<pre>@DATE 31</pre>

See Also

~!C, @YEAR, @MONTH, @DAY, @HOUR, @MINUTE, @SECOND

● @DAY

Description

This variable reads/writes the day of the week data via the Real Time Clock (RTC), which is represented by one single digit (1~7). @DAY global variable can be accessed directly without using BASIC language functions.

Syntax

Read attribute: @DAY

Range: 1(Sunday)~7(Saturday)

Note: This command is only available for TSPL2 printers. Please refer to [printer model list](#) for checking TSPL2 printers.

Example

Sample code	Result
<pre>REM *****Print***** SIZE 4,1 GAP 0,0 DIRECTION 1 CLS TEXT 10,10, "3",0,1,1, "@DAY" TEXT 210,10, "3",0,1,1,@DAY PRINT 1</pre>	<pre>@DAY 7</pre>

See Also

~!C, @YEAR, @MONTH, @DATE, @HOUR, @MINUTE, @SECOND

● @HOUR

Description

This variable reads/writes the hour data via the Real Time Clock (RTC). The 24-hour-day system (00~23) is supported by RTC. @HOUR global variable can be accessed directly without using BASIC language functions.

Syntax

Write attribute: @HOUR = "12"

Read attribute: @HOUR

Range: 00~23

Note: This command is only available for TSPL2 printers. Please refer to [printer model list](#) for checking TSPL2 printers.

Example

Sample code	Result
<pre>REM *****Set @HOUR***** @HOUR="23" REM *****Print***** SIZE 4,1 GAP 0,0 DIRECTION 1 CLS TEXT 10,10, "3",0,1,1, "@HOUR" TEXT 210,10, "3",0,1,1,@HOUR PRINT 1</pre>	<pre>@HOUR 23</pre>

See Also

~!C, @YEAR, @MONTH, @DATE, @DAY, @MINUTE, @SECOND

● @MINUTE

Description

This variable reads/writes the minute data via the Real Time Clock (RTC). The two-digits (00~59) minute format is supported by RTC. @MINUTE global variable can be accessed directly without using BASIC language functions.

Syntax

Write attribute: @MINUTE = "12"

Read attribute: @MINUTE

Range: 00~59

Note: This command is only available for TSPL2 printers. Please refer to [printer model list](#) for checking TSPL2 printers.

Example

Sample code	Result
<pre>REM *****Set @MINUTE***** @MINUTE="59" REM *****Print***** SIZE 4,1 GAP 0,0 DIRECTION 1 CLS TEXT 10,10, "3",0,1,1, "@MINUTE" TEXT 210,10, "3",0,1,1,@MINUTE PRINT 1</pre>	<pre>@MINUTE 59</pre>

See Also

~!C, @YEAR, @MONTH, @DATE, @DAY, @HOUR, @SECOND

● @SECOND

Description

This variable reads/writes the second data via the Real Time Clock (RTC). The Two-digit (00~59) second format is supported by RTC. @SECOND global variable can be accessed directly without using BASIC language functions.

Syntax

Write attribute: @SECOND = "12"

Read attribute: @SECOND

Range: 00~59

Note: This command is only available for TSPL2 printers. Please refer to [printer model list](#) for checking TSPL2 printers.

Example

Sample code	Result
<pre>REM *****Set @SECOND***** @SECOND = "59" REM *****Print***** SIZE 4,1 GAP 0,0 DIRECTION 1 CLS TEXT 10,10, "3",0,1,1, "@SECOND" TEXT 210,10, "3",0,1,1,@SECOND PRINT 1</pre>	<pre>@SECOND 59</pre>

See Also

~!C, @YEAR, @MONTH, @DATE, @DAY, @HOUR, @MINUTE

● **_MODEL\$**

Description

This variable can be read only. It includes the information of printer's model name.

Syntax

_MODEL\$

Example

Sample code

```
SIZE 4,1  
GAP 0,0  
DIRECTION 1  
CLS  
TEXT 10,10, "3",0,1,1, "Model: " + _MODEL$  
TEXT 10,60, "3",0,1,1, "Serial No.: " + _SERIAL$  
TEXT 10,110, "3",0,1,1, "F/W Version: " + _VERSION$  
PRINT 1
```

Result

```
Model: TDP247  
Serial No.: D452350388  
F/W Version: 7.00
```

See Also

_SERIAL\$, _VERSION\$

● **_SERIAL\$**

Description

This variable can be read only. It includes the information of printer's serial number.

**The printer's serial number must be programmed into printer at factory.*

Syntax

_SERIAL\$

Example

Sample code

```
SIZE 4,1  
GAP 0,0  
DIRECTION 1  
CLS  
TEXT 10,10, "3",0,1,1, "Model: " + _MODEL$  
TEXT 10,60, "3",0,1,1, "Serial No.: " + _SERIAL$  
TEXT 10,110, "3",0,1,1, "F/W Version: " + _VERSION$  
PRINT 1
```

Result

```
Model: TDP247  
Serial No.: D452350388  
F/W Version: 7.00
```

See Also

_MODEL\$, _VERSION\$

● **_VERSION\$**

Description

This variable can be read only. It includes the information of printer's firmware version.

Syntax

_SERIAL\$

Example

Sample code

```
SIZE 4,1  
GAP 0,0  
DIRECTION 1  
CLS  
TEXT 10,10, "3",0,1,1, "Model: " + _MODEL$  
TEXT 10,60, "3",0,1,1, "Serial No.: " + _SERIAL$  
TEXT 10,110, "3",0,1,1, "F/W Version: " + _VERSION$  
PRINT 1
```

Result

```
Model: TDP247  
Serial No.: D452350388  
F/W Version: 7.00
```

See Also

_MODEL\$, _VERSION\$

Wi-Fi Module Setting Commands

● WLAN OFF

Description

This command is used to disable Wi-Fi module. Restart the printer is necessary.

Syntax

WLAN OFF

Note:

We can use command SELFTEST WLAN to check the status of WLAN. The SSID is empty.

Example

Sample code	Result
<pre>WLAN OFF SELFTEST WLAN</pre>	<pre>----- WLAN SETTING ----- MAC ADDR: 001DC9-908397 MODE: INFRASTRUCTURE SSID: DHCP: OFF IP ADDR: 0.0.0.0 SUBNET: 0.0.0.0 GATEWAY: 0.0.0.0 PORT: 9100 -----</pre>

See Also

WLAN SSID

● WLAN SSID

Description

This command is used to set the SSID of your wireless network into Wi-Fi module. Restart the printer is necessary.

Syntax

WLAN SSID "ssid"

<u>Parameter</u>	<u>Description</u>
ssid	It is the SSID of your wireless network.

Note:
SSID is case-sensitive. The maximum length is 32 bytes.

Example

<u>Sample code</u>	<u>Result</u>
<pre>WLAN SSID "TEST-AP" SELFTEST WLAN</pre>	<pre>----- WLAN SETTING ----- MAC ADDR: 001DC9-908397 SSID: TEST-AP DHCP: OFF IP ADDR: 0.0.0.0 SUBNET: 0.0.0.0 GATEWAY: 0.0.0.0 PORT: 9100 -----</pre>

See Also

WLAN OFF

● WLAN WPA

Description

This command is used to set WPA security mode. This command only can be set but not be checked.
Restart the printer is necessary.

Syntax

WLAN WPA OFF

WLAN WPA "key"

<u>Parameter</u>	<u>Description</u>
OFF	Disable WPA security mode.
Key	The network security key. 8 to 63 characters. Key = Passphrase or Pre-Shared Key (Passphrase is a string containing between 8 and 63 characters) (Pre-Shared Key is a 32-byte key, formatted as hexadecimal number)

Example

<u>Sample code</u>
WLAN WPA OFF WLAN WPA "123456789"

● WLAN WEP

Description

This command is used to set WEP security mode. This command only can be set but not be checked. Restart the printer is necessary.

Syntax

WLAN WEP OFF

WLAN WEP n, "key"

<u>Parameter</u>	<u>Description</u>
OFF	Disable WEP security mode.
N	The index of key. 1 to 4.
Key	The encryption key. 5 or 13 characters or 10 or 26 hexadecimal digits.

Example

Sample code

```
WLAN WEP OFF
```

```
WLAN WEP 1, "ABCDE"
```

```
WLAN WEP 2, "ABCDE"
```

```
WLAN WEP 3, "ABCDE"
```

```
WLAN WEP 4, "4142434445"
```

● WLAN DHCP

Description

This command is used to set the printer to get the IP address from DHCP server. Restart the printer is necessary.

Syntax

WLAN DHCP

Example

Sample code	Result
<pre>WLAN SSID "TEST-AP" WLAN WPA "123456789" WLAN DHCP WLAN PORT 9100 SELFTEST WLAN</pre>	<pre>----- WLAN SETTING ----- MAC ADDR: 001DC9-908397 SSID: TEST-AP DHCP: ON IP ADDR: 10.0.10.138 SUBNET: 255.255.255.0 GATEWAY: 10.0.10.252 PORT: 9100 -----</pre>

See Also

WLAN IP

● WLAN IP

Description

This command is used to set the specific static IP address to printer. Restart the printer is necessary.

Syntax

WLAN IP "ip", "mask", "gateway"

<u>Parameter</u>	<u>Description</u>
ip	IP address.
Mask	Subnet mask.
Gateway	Default gateway.

Example

<u>Sample code</u>	<u>Result</u>
<pre>WLAN SSID "TEST-AP" WLAN WPA "123456789" WLAN IP "10.0.10.138", "255.255.255.0", "10.0.10.252" WLAN PORT 9100 SELFTEST WLAN</pre>	<pre>----- WLAN SETTING ----- MAC ADDR: 001DC9-908397 SSID: TEST-AP DHCP: OFF IP ADDR: 10.0.10.138 SUBNET: 255.255.255.0 GATEWAY: 10.0.10.252 PORT: 9100 -----</pre>

See Also

WLAN DHCP

● WLAN PORT

Description

This command is used to specify the PORT number of Wi-Fi module. Restart the printer is necessary.

Syntax

WLAN PORT number

<u>Parameter</u>	<u>Description</u>
number	Base raw port number. Default is 9100.

Example

<u>Sample code</u>	<u>Result</u>
<pre>WLAN SSID "TEST-AP" WLAN WPA "123456789" WLAN IP "10.0.10.138", "255.255.255.0", "10.0.10.252" WLAN PORT 8000 SELFTEST WLAN</pre>	<pre>----- WLAN SETTING ----- MAC ADDR: 001DC9-908397 SSID: TEST-AP DHCP: OFF IP ADDR: 10.0.10.138 SUBNET: 255.255.255.0 GATEWAY: 10.0.10.252 PORT: 8000 -----</pre>

Internal Ethernet Setting Commands

● NET DHCP

Description

This command is used to set the printer to get the IP address from DHCP server. Printer will restart itself while setting this command.

Syntax

NET DHCP

Example

Sample code	Result
<pre>NET DHCP SELFTEST ETHERNET</pre>	<pre>----- ETHERNET SETTING ----- NAME : PS-600002 MAC ADDR : 001B82-600002 DHCP : ON IP ADDR : 192.168.0.107 SUBNET : 255.255.255.0 GATEWAY : 192.168.0.1 PORT : 9100 -----</pre>

See Also

NET IP

● NET IP

Description

This command is used to set the specific IP address to printer. Printer will restart itself while setting this command.

Syntax

NET IP "ip","mask","gateway"

<u>Parameter</u>	<u>Description</u>
ip	IP address
mask	Subnet mask
gateway	Default gateway

Example

<u>Sample code</u>
<pre>NET IP "192.168.10.40","255.255.255.0","192.168.10.252" SELFTEST ETHERNET</pre>
<u>Result</u>
<pre>----- ETHERNET SETTING ----- NAME : PS-600002 MAC ADDR : 001B82-600002 DHCP : OFF IP ADDR : 192.168.10.40 SUBNET : 255.255.255.0 GATEWAY : 192.168.10.252 PORT : 9100 -----</pre>

See Also

NET DHCP

● NET PORT

Description

This command is used to specify the PORT number of Ethernet. Printer will restart itself while setting this command.

Syntax

NET PORT number

<u>Parameter</u>	<u>Description</u>
number	Base raw port number. Default is 9100.

Example

<u>Sample code</u>	<u>Result</u>
<pre>NET PORT 9100 SELFTEST ETHERNET</pre>	<pre>----- ETHERNET SETTING ----- NAME : PS-600002 MAC ADDR: 001B82-600002 DHCP : OFF IP ADDR : 192.168.10.40 SUBNET : 255.255.255.0 GATEWAY : 192.168.10.252 PORT : 9100 -----</pre>

● NET NAME

Description

This command is used to set the printer server name.

Syntax

NET NAME "printerserver"

<u>Parameter</u>	<u>Description</u>
printerserver	The specific name of printer server.

Example

<u>Sample code</u>	<u>Result</u>
<pre>NET NAME "TEST" SELFTEST ETHERNET</pre>	<pre>----- ETHERNET SETTING ----- NAME : TEST MAC ADDR: 001B82-600002 DHCP : OFF IP ADDR : 192.168.10.40 SUBNET : 255.255.255.0 GATEWAY: 192.168.10.252 PORT : 9100 -----</pre>

NFC Setting Commands

● NFC FEATURE

Description

This command is used to return information if the printer supports the optional NFC feature, and if it is currently installed.

(Supported device: Alpha-2R series)

Syntax

NFC FEATURE

<u>Parameter</u>	<u>Description</u>
None	N/A

<u>Return Information</u>	
not available	NFC is not supported
not present	The feature is unavailable. NFC is supported, but no reader is installed
present	The feature is available. NFC is supported with a reader is installed

Example

<u>Sample code</u>	<u>Result</u>
<code>NFC FEATURE</code>	Example by CommTool: <pre>present</pre>

● NFC STATUS

Description

This command is used to return current status of the NFC reader or status of last operation completed.

Syntax

NFC STATUS

<u>Parameter</u>	<u>Description</u>
None	N/A

<u>Return Information</u>	
Idle	The reader is inactive or hasn't been used
in progress	The operation is pending
timed out	The operation has timed out
successful	The operation has been completed successfully

Example

<u>Sample code</u>	<u>Result</u>
NFC STATUS	Example by CommTool: <pre>in progress</pre>

● NFC TIMEOUT

Description

This command is used to set the timeout for the current read/write operation (in seconds) 0 to 3600, setting to 0 disables the timeout feature.

Syntax

NFC TIMEOUT m

<u>Parameter</u>	<u>Description</u>
m	0 to 3600

Note:

- *The default value is 10 seconds when printer initializes.*
- *The printer will beep for notice when it's timeout.*

Example

Sample code

```
NFC TIMEOUT 20
```

● NFC READ

Description

This command is used to return content stored in the last NFC read event. (Max. of 2048 characters)

Syntax

NFC READ

<u>Parameter</u>	<u>Description</u>
None	N/A

Example

```
Sample code  
NFC READ
```

● NFC WRITE

Description

This command is used to set the content to be transmitted by the NFC system. (Max. of 2048 characters)

Syntax

NFC WRITE "content"

<u>Parameter</u>	<u>Description</u>
content	Content of text string

Example

Sample code

```
NFC WRITE "Test"
```

● NFC MODE

Description

This command is used to set the NFC reader mode. This command can start or stop a read or write operation. (Max. of 2048 characters)

Syntax

NFC MODE OFF/READ/WRITE

<u>Parameter</u>	<u>Description</u>
OFF	Disable
READ	Read tag mode
WRITE	Write tag mode

Note:
*The default value is "OFF". It returns to "OFF" after a read or write operation completes, fails or times out.
For continue to write or read data to tag, set this value to the desired "READ" or "WRITE".*

Example

Sample code

<p><u>Write data to tag once</u></p> <p>NFC MODE OFF NFC TIMEOUT 3 NFC WRITE "Test"</p> <p><u>Read data from tag once</u></p> <p>NFC MODE OFF NFC TIMEOUT 3 NFC READ</p>	<p><u>Continue to write data to tag</u></p> <p>NFC MODE WRITE NFC WRITE "123456789"</p> <p><u>Continue to read data from Tag</u></p> <p>NFC MODE READ NFC READ</p>
--	--

Alpha-2R Setting Commands

● SET PRINTQUALITY

Description

This command is used to set the print mode (print quality) for Alpha-2R series printer.
(Supported device: Alpha-2R series only)

Syntax

SET PRINTQUALITY DRAFT/STANDARD/OPTIMUM

<u>Parameter</u>	<u>Description</u>
DRAFT	High print speed with lower density
STANDARD	Standard print speed and quality
OPTIMUM	According to the label content such as barcode, text, and graphic to lower the print speed for getting higher print quality

Note:
The default value is "STANDARD".

Example

Sample code

```
SET PRINTQUALITY DRAFT  
SET PRINTQUALITY STANDARD  
SET PRINTQUALITY OPTIMUM
```

● SET STANDBYTIME

Description

This command is used to set the standby time for Alpha-2R series printer.
(Supported device: Alpha-2R series only)

Syntax

SET STANDBYTIME OFF/XXXXX

<u>Parameter</u>	<u>Description</u>
OFF	Disable
XXXXX	0 ~ 625534 (sec.)

Note:

The default value is "SET STANDBYTIME 120".

Example

Sample code

```
SET STANDBYTIME OFF  
SET STANDBYTIME 480
```

● GETSETTING\$()

Description

This command is used to get the print mode (print quality) or standby time for Alpha-2R series printer.
(Supported device: Alpha-2R series only)

Syntax

GETSETTING\$("SYSTEM","INFORMATION","PRINTQUALITY")

GETSETTING\$("SYSTEM","INFORMATION","STANDBYTIME")

<u>Parameter</u>	<u>Description</u>
None	N/A
Return Information	
PRINTQUALITY	DRAFT, STANDARD or OPTIMUM
STANDBYTIME	OFF or number

GPIO Setting Commands

● SET GPO

Description

Use this command to send out the GPIO signals by the printer.

Syntax

SET GPO *n* **signal state, delay0, pulse0, delay1, pulse1, function condition**

<u>Parameter</u>	<u>Description</u>																						
n	n = 1 ~ 7 Seven dedicated outputs are available for the desired function conditions.																						
Signal state	<table border="1"> <tr> <td>HIGH</td> <td>Goes the high level signal when the following function condition is detected.</td> </tr> <tr> <td>LOW</td> <td>Goes the low level signal when the following function condition is detected.</td> </tr> <tr> <td>POS</td> <td>Goes the positive pulse signal when the following function condition is detected.</td> </tr> <tr> <td>NEG</td> <td>Goes the negative pulse signal when the following function condition is detected.</td> </tr> </table>	HIGH	Goes the high level signal when the following function condition is detected.	LOW	Goes the low level signal when the following function condition is detected.	POS	Goes the positive pulse signal when the following function condition is detected.	NEG	Goes the negative pulse signal when the following function condition is detected.														
HIGH	Goes the high level signal when the following function condition is detected.																						
LOW	Goes the low level signal when the following function condition is detected.																						
POS	Goes the positive pulse signal when the following function condition is detected.																						
NEG	Goes the negative pulse signal when the following function condition is detected.																						
Delay0	After detecting the following function condition, the printer will wait this period of time before sending out the “true” output signal. Unit: millisecond. Maximum: 32000.																						
Pulse0	Pulse width corresponding to the function condition becoming “true”. (Ignored for level-type signals.) Unit: millisecond. Maximum: 32000.																						
Delay1	After detecting the following function condition, the printer will wait this period of time before sending out the “false” output signal. Unit: millisecond. Maximum: 32000.																						
Pulse1	Pulse width corresponding to the function condition becoming “false”. (Ignored for level-type signals.) Unit: millisecond. Maximum: 32000.																						
Function condition (warning, error, control...)	<table border="1"> <tr> <td>FAULT</td> <td>Printer fault.</td> </tr> <tr> <td>FAULT RIBBON</td> <td>Ribbon error is occurred.</td> </tr> <tr> <td>FAULT PAPER</td> <td>Paper empty or paper jam is occurred.</td> </tr> <tr> <td>FAULT CARRIAGE</td> <td>Carriage is open.</td> </tr> <tr> <td>FAULT MEMORY</td> <td>Out of memory is occurred.</td> </tr> <tr> <td>FAULT CUTTER</td> <td>Cutter error is occurred.</td> </tr> <tr> <td>FAULT OVERHEAT</td> <td>Stepping motor or print head is over heat.</td> </tr> <tr> <td>PAUSE</td> <td>Pause status is occurred.</td> </tr> <tr> <td>TAKELABEL</td> <td>Take label is occurred.</td> </tr> <tr> <td>IDLE</td> <td>Printer is idle.</td> </tr> <tr> <td>PRINT</td> <td>Printer is printing.</td> </tr> </table>	FAULT	Printer fault.	FAULT RIBBON	Ribbon error is occurred.	FAULT PAPER	Paper empty or paper jam is occurred.	FAULT CARRIAGE	Carriage is open.	FAULT MEMORY	Out of memory is occurred.	FAULT CUTTER	Cutter error is occurred.	FAULT OVERHEAT	Stepping motor or print head is over heat.	PAUSE	Pause status is occurred.	TAKELABEL	Take label is occurred.	IDLE	Printer is idle.	PRINT	Printer is printing.
FAULT	Printer fault.																						
FAULT RIBBON	Ribbon error is occurred.																						
FAULT PAPER	Paper empty or paper jam is occurred.																						
FAULT CARRIAGE	Carriage is open.																						
FAULT MEMORY	Out of memory is occurred.																						
FAULT CUTTER	Cutter error is occurred.																						
FAULT OVERHEAT	Stepping motor or print head is over heat.																						
PAUSE	Pause status is occurred.																						
TAKELABEL	Take label is occurred.																						
IDLE	Printer is idle.																						
PRINT	Printer is printing.																						

Example

Sample code

```
SET GPO1 HIGH,100,0,100,0,FAULT RIBBON  
SET GPO2 LOW,100,0,100,0,FAULT PAPER  
SET GPO3 POS,100,100,100,100,PAUSE  
SET GPO4 NEG,100,50,100,50,IDLE
```

● SET GPI

Description

Use this command to receive the GPIO signals from external controlling devices.

Syntax

SET GPIn signal, pulse, function

<u>Parameter</u>	<u>Description</u>																				
n	n = 1 ~ 4 Four dedicated inputs are available for the desired control functions.																				
Signal state	<table border="1"> <tr> <td>HIGH</td> <td>When a high level signal received, will activate the following printer control functions.</td> </tr> <tr> <td>LOW</td> <td>When a low level signal received, will activate the following printer control functions.</td> </tr> <tr> <td>POS</td> <td>When a positive pulse signal received, will activate the following printer control functions.</td> </tr> <tr> <td>NEG</td> <td>When a negative pulse signal received, will activate the following printer control functions.</td> </tr> </table>	HIGH	When a high level signal received, will activate the following printer control functions.	LOW	When a low level signal received, will activate the following printer control functions.	POS	When a positive pulse signal received, will activate the following printer control functions.	NEG	When a negative pulse signal received, will activate the following printer control functions.												
HIGH	When a high level signal received, will activate the following printer control functions.																				
LOW	When a low level signal received, will activate the following printer control functions.																				
POS	When a positive pulse signal received, will activate the following printer control functions.																				
NEG	When a negative pulse signal received, will activate the following printer control functions.																				
Pulse	Filter pulse width. Ignored for level-type signals. Unit: millisecond. Maximum: 32000.																				
Function (control)	<table border="1"> <tr> <td>PAUSE</td> <td>Toggle pause status.</td> </tr> <tr> <td>PAUSE ON</td> <td>Enter pause status.</td> </tr> <tr> <td>PAUSE OFF</td> <td>Cancel pause status.</td> </tr> <tr> <td>PRINT</td> <td>Print batch of labels.</td> </tr> <tr> <td>PRINT n</td> <td>n is numerical. Specify how many labels to print. Maximum: 32000.</td> </tr> <tr> <td>CUT</td> <td>Cut immediately.</td> </tr> <tr> <td>FEED n</td> <td>n is numerical and the unit is dot. Specify the feeding length. Maximum: 32000.</td> </tr> <tr> <td>BACKFEED n</td> <td>n is numerical and the unit is dot. Specify the backfeeding length. Maximum: 32000.</td> </tr> <tr> <td>FORMFEED</td> <td>Feeding an empty label.</td> </tr> <tr> <td>INPUT n</td> <td>n is text or command. The n will be triggered to printer.</td> </tr> </table>	PAUSE	Toggle pause status.	PAUSE ON	Enter pause status.	PAUSE OFF	Cancel pause status.	PRINT	Print batch of labels.	PRINT n	n is numerical. Specify how many labels to print. Maximum: 32000.	CUT	Cut immediately.	FEED n	n is numerical and the unit is dot. Specify the feeding length. Maximum: 32000.	BACKFEED n	n is numerical and the unit is dot. Specify the backfeeding length. Maximum: 32000.	FORMFEED	Feeding an empty label.	INPUT n	n is text or command. The n will be triggered to printer.
PAUSE	Toggle pause status.																				
PAUSE ON	Enter pause status.																				
PAUSE OFF	Cancel pause status.																				
PRINT	Print batch of labels.																				
PRINT n	n is numerical. Specify how many labels to print. Maximum: 32000.																				
CUT	Cut immediately.																				
FEED n	n is numerical and the unit is dot. Specify the feeding length. Maximum: 32000.																				
BACKFEED n	n is numerical and the unit is dot. Specify the backfeeding length. Maximum: 32000.																				
FORMFEED	Feeding an empty label.																				
INPUT n	n is text or command. The n will be triggered to printer.																				

Example

Sample code

```
SET GPI1 HIGH,0,PAUSE
SET GPI2 LOW,0,PAUSE ON
SET GPI3 POS,100,PAUSE OFF
SET GPI4 NEG,100,CUT
SET GPI5 NEG,100,INPUT "TEST.BAS"+CHR$(13)+CHR$(10)
```

GPIO Waveform

GPI Level Signal : Continuous action. (Host to printer.)

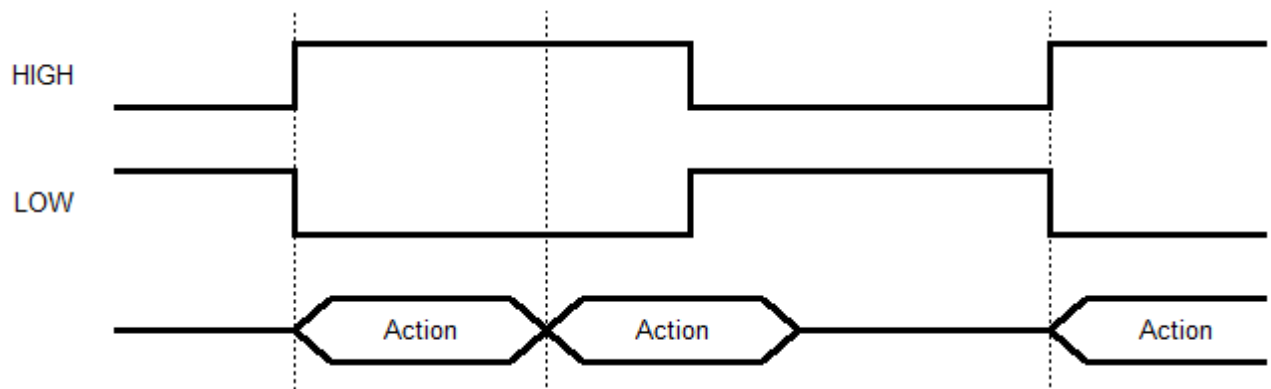

GPI Pulse Signal : A pulse is an action. (Host to printer.)

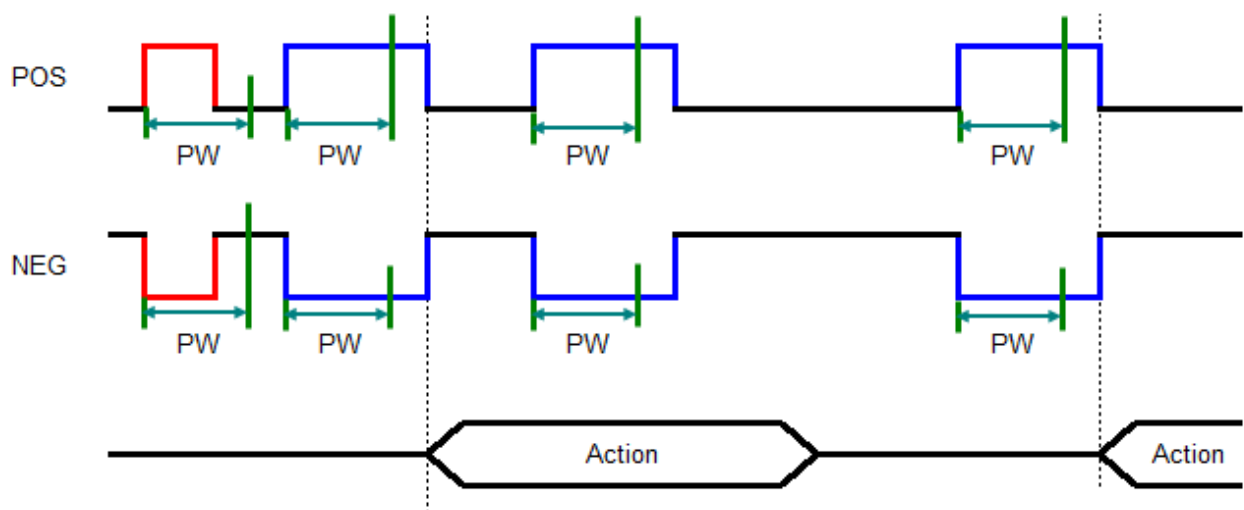

GPO Level Signal : Continuous condition. (Printer to host.)

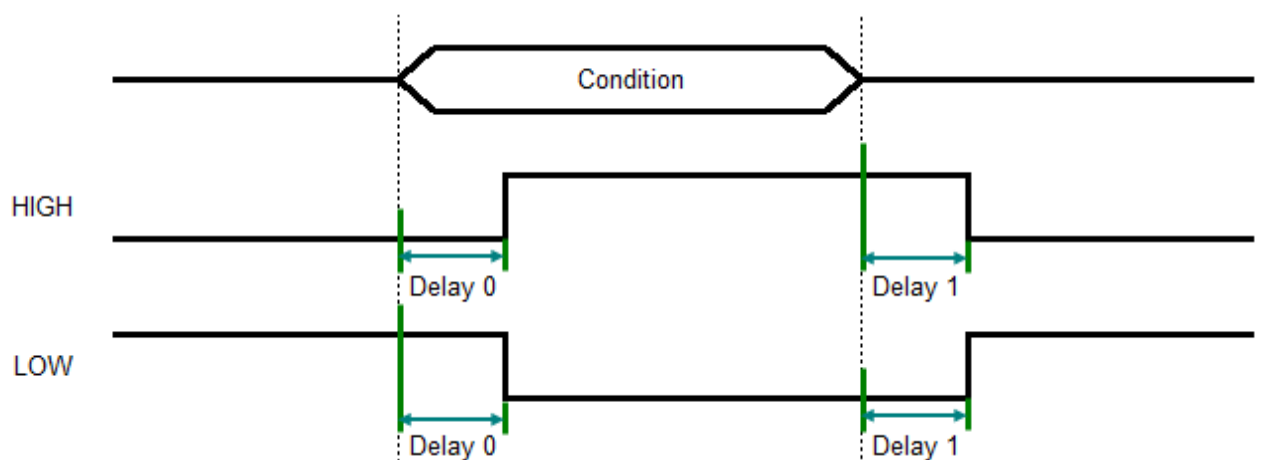

GPO Pulse Signal : A pulse is a condition. (Printer to host.)

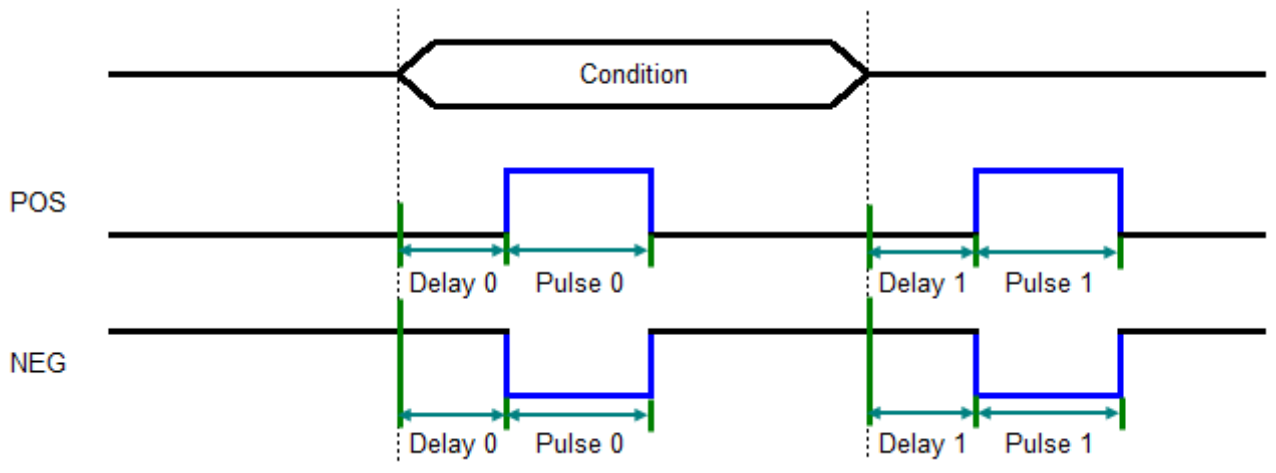

GPIO Circuit Diagram

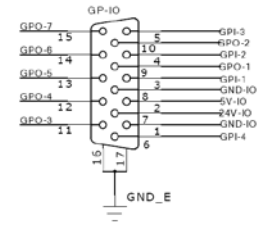
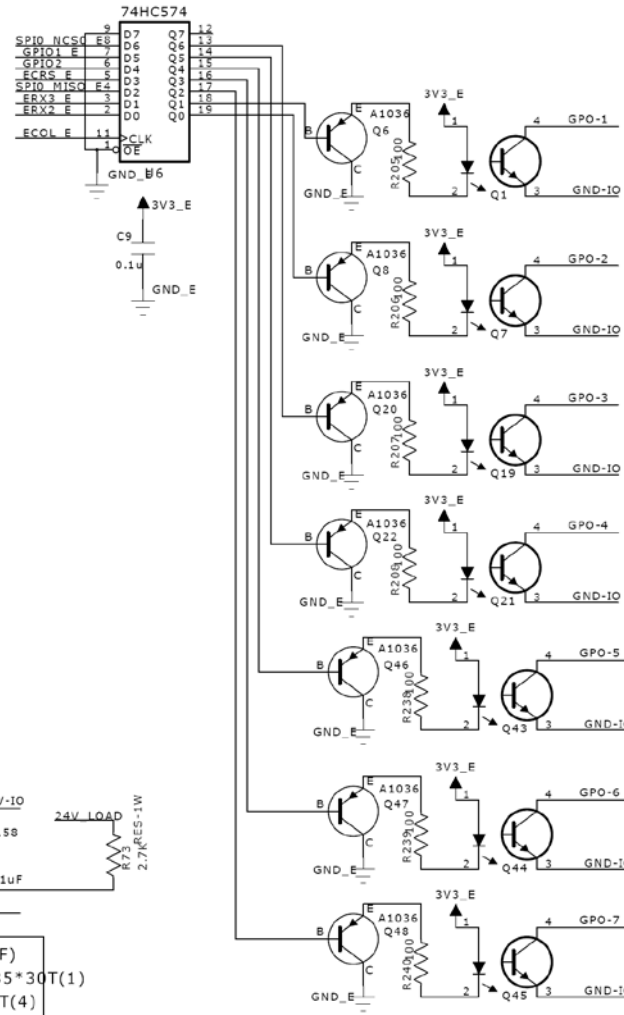
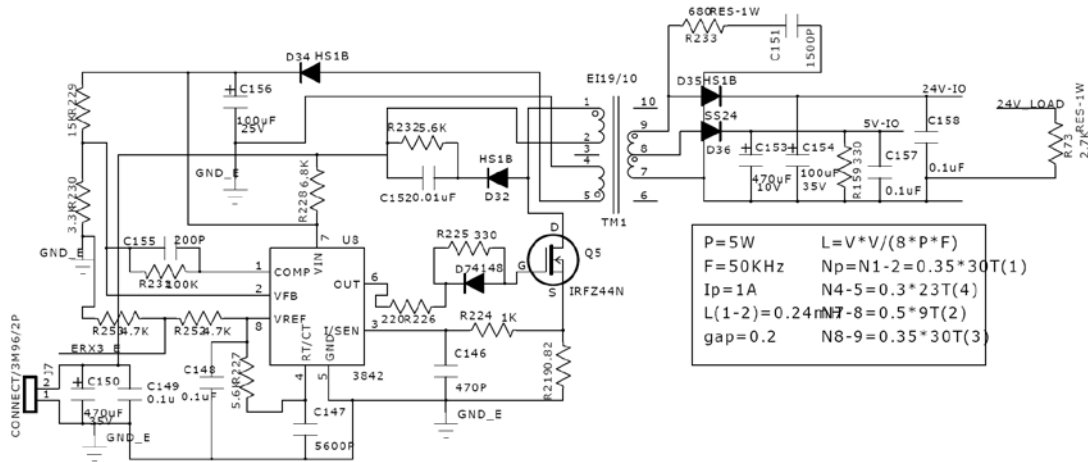
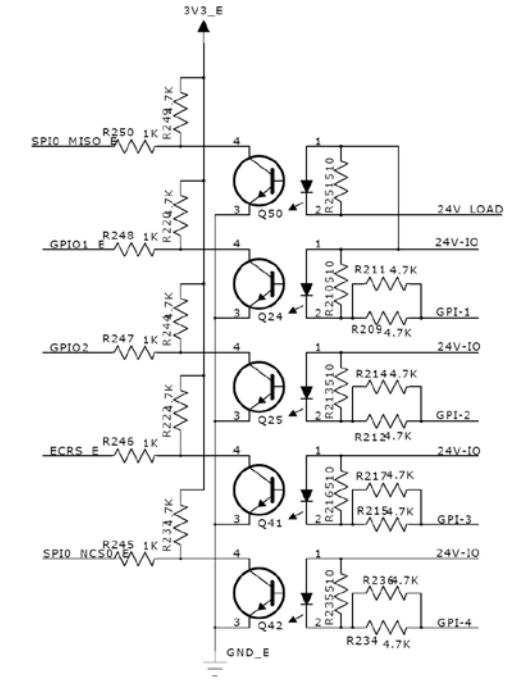

TTP-2410MT/ MXP/ MH series

PIN No.	Signal Name
1	GND-IO
2	5V-IO
3	GPI-1
4	GPI-2
5	GPI-3
6	GPI-4
7	24V-IO
8	GND-IO
9	GPO-1
10	GPO-2
11	GPO-3
12	GPO-4
13	GPO-5
14	GPO-6
15	GPO-7

TTP-384M series

PIN No.	Signal Name
1	GND-IO
2	5V-IO
3	GPI-1
4	GPI-2
5	N/A
6	N/A
7	24V-IO
8	GND-IO
9	N/A
10	N/A
11	N/A
12	GPO-4
13	GPO-5
14	N/A
15	GPO-7

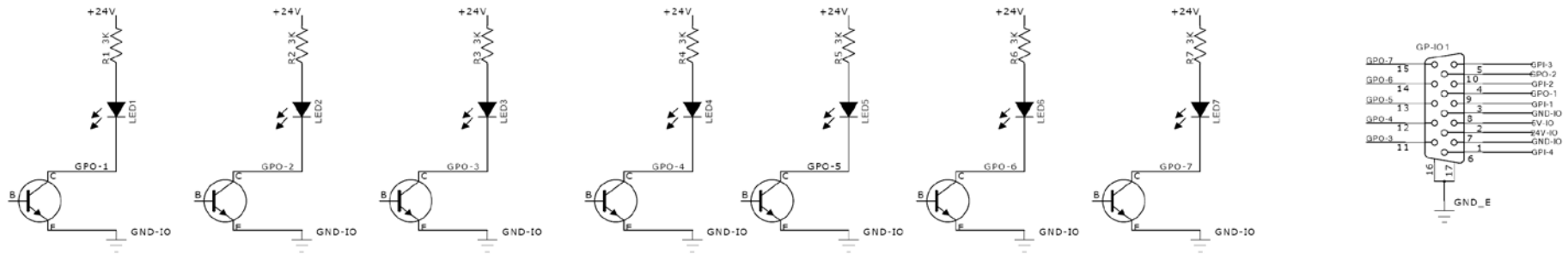

GPO pin no. 1~7 application example:

Since we connect GPO pin no. 1~7 with seven individual LED, the output signal from GPO will light the individual LED on or off.

*NPN output specification.

Collector-emitter voltage	V_{CEO}	35 V
Emitter-collector voltage	V_{CEO}	6 V
Collector current	I_C	Max. 50 mA
*1 Collector power dissipation	P_C	150 mW

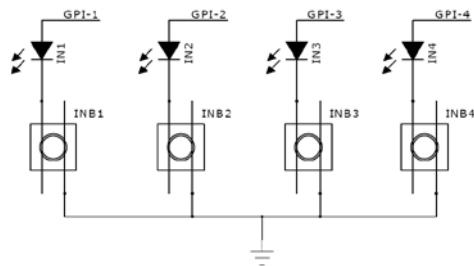

GPI pin no. 1~4 application example:

Since we connect GPI pin no. 1~4 with four individual button keys to control the desired printer functions. The input signal current suggests 20 mA.

Update History

Date	Content	Editor
2007/07/13	Revise some typos	Phil
2007/12/25	Revise FREAD\$() example	Camille
2008/04/10	Add update history list	Camille
2009/01/17	Add GAPDETECT command	Ken
2009/05/18	Add CIRCLE command	Phil
2009/06/24	Add RSS command	Phil
2010/07/06	Revise bar command section	Camille
2010/10/25	Revise some sections	Camille
2011/01/06	Add CODE 11 barcode	Ernest
2011/01/06	Add AZTEC barcode	Ernest
2011/01/06	Revise sensor intension table in SET GAP command	Ernest
2011/01/10	Add BLINEDetect command	Ernest
2011/01/10	Add AUTODETECT command	Ernest
2011/01/10	Add BASIC function FORMAT\$()	Ernest
2011/01/10	Add BASIC function NOW\$()	Ernest
2011/01/10	Add BASIC function TRIM\$()	Ernest
2011/01/10	Add BASIC function LTRIM\$()	Ernest
2011/01/10	Add BASIC function RTRIM\$()	Ernest
2010/01/10	Add BASIC function STRCOMP()	Ernest
2010/01/10	Add BASIC function INSTR()	Ernest
2011/01/25	Modify TSC address	Camille
2011/03/04	Revise, TTP-248M doesn't support mirror function	Ernest
2011/03/04	Add sensor range of TTP-225/ TDP-225 in command SET GAP	Ernest
2011/12/09	Add some command spec in RSS barcode.	Ernest
2012/11/20	Add command SET USBHOST KEYBOARD/SCANNER	Ernest
2012/11/20	Revise STRCOMP() example	Ernest
2012/11/20	Revise TRIM\$(), LTRIM\$(), RTRIM\$() example.	Ernest
2012/11/20	Add <ESC>!P command.	Ernest
2012/11/20	Add <ESC>!O command.	Ernest
2012/11/20	Revise OUT command.	Ernest
2012/11/20	Add SET BLINE command.	Ernest
2012/11/20	Add ELLIPSE command.	Ernest
2012/11/20	Add SET RIBBONEND command.	Ernest
2012/11/20	Add SET ENCODER command.	Ernest
2012/11/21	Revise TEXT command.	Ernest
2012/11/21	Revise speed table of SPEED command.	Ernest
2012/11/21	Revise AZTEC command.	Ernest
2012/11/21	Add BLOCK command.	Ernest
2012/11/21	Add PUT command.	Ernest
2012/11/21	Add GET command.	Ernest
2012/11/21	Add INP() command.	Ernest
2012/11/22	Revise PUTBMP command. Support grayscale printing in direct thermal printing.	Ernest
2012/11/22	Revise BARCODE command. New support barcode TELEPEN, TELEPENN, PLANET, CODE49, DPI, DPL.	Ernest
2012/11/23	Add TLC39 barcode.	Ernest
2012/11/23	Add CODABLOCK command (F mode only).	Ernest
2012/11/23	Add SELFTEST PATTERN command.	Ernest
2012/11/23	Revise the supported CODEPAGE table and example.	Ernest
2012/11/23	Add global variable NOW.	Ernest
2012/11/26	Add DATEADD() command.	Ernest
2012/11/26	Add SET AUTORUN command.	Ernest
2012/11/26	Add LOC() command.	Ernest
2012/11/26	Add NOW\$() command.	Ernest
2012/11/26	Revise SET RIBBON command.	Ernest
2012/11/26	Revise SET COUNTER command.	Ernest
2012/11/26	Add <ESC>!C command.	Ernest
2012/11/26	Add <ESC>!Q command.	Ernest
2012/11/26	Add <ESC>!S command.	Ernest
2012/11/26	Add OUTR command.	Ernest
2012/11/26	Add <ESC>!D command.	Ernest
2012/11/26	Add ~!E command.	Ernest
2012/11/27	Add LOB() command.	Ernest
2012/11/27	Add WHILE ... WEND command.	Ernest
2012/11/27	Add DO ... LOOP command.	Ernest

2012/11/27	Add TEXTPIXEL() command.	Ernest
2012/11/27	Add BARCODEPIXEL() command.	Ernest
2012/11/27	Add GETSENSOR() command.	Ernest
2012/11/27	Add GETSETTING() command.	Ernest
2012/11/28	Revise SET CUTTER command.	Ernest
2012/11/28	Revise OPEN command.	Ernest
2012/11/28	Revise FOR ... NEXT LOOP command.	Ernest
2012/11/28	Add CLOSE command.	Ernest
2012/11/28	Add COPY command.	Ernest
2012/11/28	Add MPDF417 command for Micro PDF 417 barcode.	Ernest
2012/11/30	Add EOJ command.	Ernest
2012/11/30	Add DELAY command.	Ernest
2012/11/30	Add DISPLAY command.	Ernest
2012/11/30	Add XOR\$() command.	Ernest
2012/11/30	Add _MODEL\$ variable.	Ernest
2012/11/30	Add _SERIAL\$ variable.	Ernest
2012/11/30	Add _VERSION\$ variable.	Ernest
2012/11/30	Revise LIMITFEED command.	Ernest
2012/11/30	Revise BOX command.	Ernest
2012/11/30	Add SET FEED_LEN command.	Ernest
2012/12/20	Add external Wi-Fi module setting commands.	Ernest
2012/12/20	Add Ethernet setting commands.	Ernest
2012/12/24	Revise DMATRIX command.	Ernest
2012/12/24	Revise LIMITFEED command.	Ernest
2012/12/24	Revise SELFTEST command	Camille
2013/2/5	Add sample result for each section	Camille
2013/2/6	Add CODEPAGE 864 (Arabic) ; since F/W V7.0	Camille
2013/2/26	Add <ESC>!F command.	Camille
2013/2/26	Add <ESC>! . Command.	Camille
2013/6/25	Modify sample code for PUTPCX command	Camille
2013/12/13	Modify GAP and BLINE command	Camille
2014/1/22	Add INITIALPRINTER command	Camille
2014/3/28	Modify sample code for SET COUNTER command	Samuel
2014/4/15	Add GPIO setting commands	Camille
2014/6/11	Modify SPEED section	Camille
2014/6/12	Modify BACKFEED & BACKUP section	Camille
2014/6/12	Modify DIRECTION section	Camille
2014/6/12	Modify SHIFT section	Camille
2014/6/12	Modify HOME section	Camille
2014/6/12	Modify BARCODE section	Camille
2014/6/12	Modify PUTBMP section	Camille
2014/6/12	Modify PUTPCX section	Camille
2014/6/12	Modify QRCODE section	Camille
2014/6/12	Modify TEXT section	Camille
2014/6/12	Modify ~!T section	Camille
2014/6/12	Modify DOWNLOAD section	Camille
2014/6/12	Modify KILL section	Camille
2014/6/12	Modify RUN section	Camille
2014/6/13	Add <ESC> Y command	Camille
2014/6/13	Add <ESC> Z command	Camille
2014/6/13	Modify IF...THEN...ELSE...ENDIF LOOP section	Camille
2014/6/13	Modify GETKEY() section	Camille
2014/6/13	Modify SET PARTIAL_CUTTER section	Camille
2014/6/17	Modify SET BACK section	Camille
2014/6/18	Modify SET KEY1, SET KEY2, SET KEY3 section	Camille
2014/6/18	Modify TEAR & SETSTRIPER section	Camille
2014/6/18	Modify SET HEAD section	Camille
2014/6/18	Modify SET PRINTKEY section	Camille
2014/6/18	Modify SET REPRINT section	Camille
2014/6/18	Modify KEY1, KEY2, KEY3 section	Camille
2014/6/18	Modify @YEAR, @MONTH, @DATE, @DAY, @HOUR, @MINUTE and @SECOND sections	Camille
2014/6/19	Modify SET LED1, SET LED2, SET LED3 section	Camille
2014/6/19	Modify LED1, LED2, LED3 section	Camille
2014/6/19	Modify SET GAP section	Camille
2014/6/20	Modify printer model list	Camille
2014/8/1	Modify GPO example	Camille

2014/10/14	Modify GPO function (Add PRINT)	Camille
2014/11/28	Modify printer model list	Camille
2014/11/28	Add SET REWIND section	Camille
2015/3/11	Modify printer model list	Camille
2015/4/10	Modify SPEED section	Camille
2015/5/11	Modify <ESC>IS command section (Add Print head error)	Camille
2015/5/15	Revise OFFSET command section	Camille
2015/9/11	Revise GETSETTING\$() section	Camille
2015/10/29	Modify SHIFT section Modify SET KEY section Modify PUTBMO section Add SET RESPONSE section	Camille
2015/10/30	Modify GPIO section	Camille
2015/11/18	Add DIAGONAL command Modify SET USBHOST section	Camille
2015/11/19	Modify DISPLAY section	Camille
2015/11/24	Add FSEARCH() command Add SET VERIFIER command	Camille
2015/11/25	Add TOUCHPRESS() command	Camille
2015/12/8	Modify DMATRIX section (add a# parameter)	Camille
2015/12/17	Add SET RS232_REWINDER command	Camille
2016/2/4	Add RECORDSET\$() command	Camille
2016/4/11	Add FNC sample code on DMATRIX section	Camille
2016/7/11	Modify SET KEYn section	Camille
2016/7/11	Update printer model list	Camille
2016/9/26	Update GETSETTING\$() section	Camille
2017/1/18	Add SET DAYLIGHT_SAVE command	Camille
2017/1/18	Add rectangular shape sample code on DMATRIX section	Camille
2017/1/18	Add LABELRATIO command	Camille
2017/2/15	Add NFC setting Command section	Camille
2017/3/8	Modify BLOCK section	Camille
2017/4/5	Modify SET KEYn section	Camille
2017/4/5	Modify KEY1, SET KEY2, SET KEY3 section	Camille
2017/4/5	Update printer model list	Camille
2017/4/5	Modify SPEED section	Camille
2017/4/6	Modify SET LEDn section	Camille
2017/4/6	Modify LED1, LED2, LED3 section	Camille
2017/4/11	Modify KEY1, SET KEY2, SET KEY3 section	Camille
2017/4/14	Add smart phone data string on QRCODE section	Camille
2017/4/17	Modify FORMAT\$ () section (sample code)	Camille
2017/5/16	Add setting command section for Alpha-2R	Camille
2017/6/7	Add new parameters for QRCODE command	Camille
2017/6/8	Add MENU command	Camille
2017/6/8	Add sample code for [fit] parameter on BLOCK section	Camille
2017/6/8	Add sample code for (") on RECORDSET\$ () section	Camille
2017/7/21	Add EAN128M to BARCODE section	Camille
2017/8/17	Add new parameters for SET REWIND command	Camille
2017/9/15	Add new parameters & examples for FORMAT\$ () command	Camille
2017/10/16	Add the standard symbol sizes for DataMatrix 2D barcode on DMATRIX section	Camille
2017/10/23	- Modify the <ESC>IS section (#2: warning) - Add a parameter for SET GPI command	Camille
2017/11/22	Remove WLAN MODE (Ad-hoc)	Camille
2018/1/19	Update GPIO info.	Camille
2018/2/6	Add a sample for RSS command	Camille
2018/2/7	Add the new parameter for GETSETTING command	Camille
2018/2/12	Add the QRcode sample code for smart phone data string	Camille
2018/2/13	Modify a parameter for SET GPI command	Camille
2018/3/1	Update FORMAT\$ () section	Camille
2018/5/17	Update the sample Code 1 for RECORDSET\$ () section	Camille
2018/7/13	Add parameters(25S/25I) for BARCODE command	Camille
2018/8/6	Modify the SIZE section ("n" can be an optional item)	Camille
2018/9/14	Add DNS parameter for GETSETTING\$() command	Camille
2018/9/25	Modify <ESC>ID section	Camille
2018/10/9	Add battery parameters and sample code on GETSENSOR() command section	Camille



TSC Auto ID Technology Co., Ltd.

Corporate Headquarters

9F., No.95, Minquan Rd., Xindian Dist.,
New Taipei City 23141, Taiwan (R.O.C.)

TEL: +886-2-2218-6789

FAX: +886-2-2218-5678

Web site: www.tscprinters.com

E-mail: printer_sales@tscprinters.com

tech_support@tscprinters.com

Li Ze Plant

No.35, Sec. 2, Ligong 1st Rd., Wujie Township,
Yilan County 26841, Taiwan (R.O.C.)

TEL: +886-3-990-6677

FAX: +886-3-990-5577