

ML240/ ML340/ ML240P/ ML340P Series

**THERMAL TRANSFER / DIRECT THERMAL
BAR CODE PRINTER**

**USER'S
MANUAL**

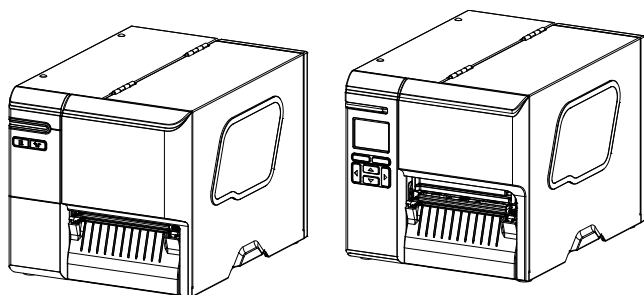

Copyright Information

©2019 TSC Auto ID Technology Co., Ltd,

The copyright in this manual, the software and firmware in the printer described therein are owned by TSC Auto ID Technology Co., Ltd, All rights reserved.

CG Triumvirate is a trademark of Agfa Corporation. CG Triumvirate Bold Condensed font is under license from the Monotype Corporation. Windows is a registered trademark of Microsoft Corporation.

All other trademarks are the property of their respective owners.

Information in this document is subject to change without notice and does not represent a commitment on the part of TSC Auto ID Technology Co. No part of this manual may be reproduced or transmitted in any form or by any means, for any purpose other than the purchaser's personal use, without the expressed written permission of TSC Auto ID Technology Co.

Agency Compliance and Approvals



EN 55032, Class A

EN 55035

EN 60950-1

This is a class A product. In a domestic environment this product may cause radio interference in which case the user may be required to take adequate measures.



FCC part 15B, Class A

ICES-003, Class A

This equipment has been tested and found to comply with the limits for a Class A digital device, pursuant to Part 15 of the FCC Rules. These limits are designed to provide reasonable protection against harmful interference when the equipment is operated in a commercial environment.

This equipment generates, uses, and can radiate radio frequency energy and, if not installed and used in accordance with the manufacturer's instruction manual, may cause harmful interference with radio communications. Operation of this equipment in a residential area is likely to cause harmful interference, in which case you will be required to correct the interference at your own expense.

This Class A digital apparatus complies with Canadian ICES-003.

Cet appareil numérique de la classe A est conforme à la norme NMB-003 du Canada.

This device complies with Part 15 of the FCC Rules. Operation is subject to the following two conditions: (1) This device may cause harmful interference, and (2) this device must accept any interference received, including interference that may cause undesired operation.



AS/NZS CISPR 32, Class A



UL 62368-1
CSA C22.2 No. 62368-1



EN 62368-1



KN 32 / KN 35 / K 60950-1

이 기기는 업무용(A 급) 전자파적합기기로서 판매자 또는 사용자는 이 점을 주의하시기 바라며, 가정외의 지역에서 사용하는 것을 목적으로 합니다.



GB 4943.1

GB/T9254, Class A

GB 17625.1

此为 A 级产品，在生活环境中，该产品可能会造成无线电干扰，在这种情况下，可能需要用户对干扰采取切实可行的措施。



Energy Star for Imaging Equipment Version 2.0



IS 13252(Part 1)/

IEC 60950-1



CNS 13438

CNS 14336-1

CNS 15663



LP0002

Note: There may have certification differences in the series models, please refer to product label for accuracy.

Important safety instructions:

1. Read all of these instructions and keep them for later use.
2. Follow all warnings and instructions on the product.
3. Disconnect the power plug from the AC outlet before cleaning or if fault happened.

Do not use liquid or aerosol cleaners. Using a damp cloth is suitable for cleaning.

4. The mains socket shall be installed near the equipment and easily accessible.
5. The unit must be protected against moisture.
6. Ensure the stability when installing the device, Tipping or dropping could cause damage.
7. Make sure to follow the correct power rating and power type indicated on marking label provided by manufacture.
8. Please refer to user manual for maximum operation ambient temperature.

WARNING:

Hazardous moving parts, keep fingers and other body parts away.

CAUTION:

(For equipment with RTC (CR2032) battery or rechargeable battery pack)

Risk of explosion if battery is replaced by an incorrect type.

Dispose of used batteries according to the Instructions as below.

1. DO NOT throw the battery in fire.
2. DO NOT short circuit the contacts.
3. DO NOT disassemble the battery.
4. DO NOT throw the battery in municipal waste.
5. The symbol of the crossed out wheeled bin indicates that the battery should not be placed in municipal waste.



Caution: The printhead may be hot and could cause severe burns. Allow the printhead to cool.

WARNING:

For operation safety, please turn off the power by the power switch before opening the media cover to load labels, ribbons, or to repair. After completing the steps, please close the media cover first and then turn on the power to start printing.

CAUTION:

Any changes or modifications not expressly approved by the grantee of this device could void the user's authority to operate the equipment.

Below statement are for product with optional RF function.

CE Statement:

This equipment complies with EU radiation exposure limits set forth for an uncontrolled environment. This equipment should be installed and operated with minimum distance 20 cm between the radiator & your body.

All operational modes:

2.4GHz: 802.11b, 802.11g, 802.11n (HT20), 802.11n (HT40)

5GHz: 802.11a,

The frequency, mode and the maximum transmitted power in EU are listed below:

2400 MHz – 2483.5 MHz: 19.88 dBm (EIRP)(Wi-Fi)

5150 MHz – 5250 MHz: 17.51 dBm (EIRP)(Wi-Fi)

2402 MHz – 2480 MHz: 6.02 dBm (EIRP)(Bluetooth)

Requirements in

AT/BE/BG/CZ/DK/EE/FR/DE/IS/IE/IT/EL/ES/CY/LV/LI/LT/LU/HU/MT/NL/NO/PL/PT/RO/SI/SK/TR/FI/SE/CH/UK/H

R. 5150MHz~5350MHz is for indoor use only.

5150-5350MHz for Only indoor use

5470-5725MHz for indoor/outdoor use



Restrictions In AZE

National restrictions information is provided below

Frequency Band	Country	Remark
5150-5350MHz	Azerbaijan	No license needed if used indoor and power not exceeding 30mW
5470-5725MHz		

Hereby, TSC Auto ID Technology Co., Ltd. declares that the radio equipment type [Wi-Fi] IEEE 802.11 a/b/g/n is in compliance with Directive 2014/53/EU

The full text of the EU declaration of conformity is available at the following internet address:

<https://www.tscprinters.com/EN/support>

Canada, Industry Canada (IC) Notices

This Class B digital apparatus complies with Canadian ICES-003 and RSS-210.

Operation is subject to the following two conditions: (1) this device may not cause interference, and (2) this device must accept any interference, including interference that may cause undesired operation of the device.

Canada, avis de l'Industry Canada (IC)

Cet appareil numérique de classe B est conforme aux normes canadiennes ICES-003 et RSS-210.

Son fonctionnement est soumis aux deux conditions suivantes : (1) cet appareil ne doit pas causer d'interférence et (2) cet appareil doit accepter toute interférence, notamment les interférences qui peuvent affecter son fonctionnement.

NCC 警語:

經型式認證合格之低功率射頻電機，非經許可，公司、商號或使用者均不得擅自變更頻率、加大功率或變更原設計之特性及功能。(即低功率電波輻射性電機管理辦法第十二條)

低功率射頻電機之使用不得影響飛航安全及干擾合法通信；經發現有干擾現象時，應立即停用，並改善至無干擾時方得繼續使用。

前項合法通信，指依電信法規定作業之無線電通信。低功率射頻電機須忍受合法通信或工業、科學及醫療用電波輻射性電機設備之干擾。(即低功率電波輻射性電機管理辦法第十四條)

BSMI Class A 警語:

這是甲類的資訊產品，在居住的環境使用中時，可能會造成射頻干擾，在這種情況下，使用者會被要求採取某些適當的對策。

MFi for Bluetooth



Use of the Made for Apple badge means that an accessory has been designed to connect specifically to the Apple product(s) identified in the badge, and has been certified by the developer to meet Apple performance standards. Apple is not responsible for the operation of this device or its compliance with safety and regulatory standards.

For US Model

Made for iPhone®XS Max, iPhone XS, iPhone XR, iPhone X, iPhone 8, iPhone 8 Plus, iPhone 7, iPhone 7 Plus, iPhone SE, iPhone 6s, iPhone 6s Plus, iPhone 6, iPhone 6 Plus, iPhone 5s, iPad Pro® 12.9-inch (2nd generation), iPad Pro 10.5-inch, iPad® (6th generation),

iPad (5th generation), iPad Pro 9.7-inch, iPad Pro 12.9-inch (1st generation), iPad Air® 2,
iPad mini™ 4, iPad mini 3, iPad Air, iPad mini 2, iPod touch® (6th generation)

iPad, iPad Air, iPad Pro, iPhone are trademarks of Apple Inc., registered in the U.S. and other countries.

For JP Model

Made for iPhone XS Max, iPhone XS, iPhone XR, iPhone X, iPhone 8, iPhone 8 Plus, iPhone 7,
iPhone 7 Plus, iPhone SE, iPhone 6s, iPhone 6s Plus, iPhone 6, iPhone 6 Plus, iPhone 5s,
iPad Pro 12.9-inch (2nd generation), iPad Pro 10.5-inch, iPad (6th generation), iPad (5th generation),
iPad Pro 9.7-inch, iPad Pro 12.9-inch (1st generation), iPad Air 2, iPad mini 4, iPad mini 3, iPad Air,
iPad mini 2, iPod touch (6th generation)

iPad, iPad Air, iPad Pro, iPhone are trademarks of Apple Inc., registered in the U.S. and other countries. The
trademark “iPhone” is used in Japan with a license from Aiphone K.K.

Except for US, JP Model

Made for iPhone XS Max, iPhone XS, iPhone XR, iPhone X, iPhone 8, iPhone 8 Plus, iPhone 7,
iPhone 7 Plus, iPhone SE, iPhone 6s, iPhone 6s Plus, iPhone 6, iPhone 6 Plus, iPhone 5s,
iPad Pro 12.9-inch (2nd generation), iPad Pro 10.5-inch, iPad (6th generation), iPad (5th generation),
iPad Pro 9.7-inch, iPad Pro 12.9-inch (1st generation), iPad Air 2, iPad mini 4, iPad mini 3, iPad Air,
iPad mini 2, iPod touch (6th generation)

iPad, iPad Air, iPad Pro, iPhone are trademarks of Apple Inc., registered in the U.S. and other countries.

單元Unit	限用物質及其化學符號 Restricted substances and its chemical symbols					
	鉛Lead (Pb)	汞Mercury (Hg)	鎘Cadmium (Cd)	六價鉻 Hexavalent chromium (Cr ⁺⁶)	多溴聯苯 Polybrominated biphenyls (PBB)	多溴二苯醚 Polybrominated diphenyl ethers (PBDE)
內外塑膠件	○	○	○	○	○	○
內外鐵件	-	○	○	○	○	○
滾輪	○	○	○	○	○	○
銘版	○	○	○	○	○	○
電路板	-	○	○	○	○	○
晶片電阻	-	○	○	○	○	○
積層陶瓷表面 黏著電容	○	○	○	○	○	○
集成電路-IC	-	○	○	○	○	○
電源供應器	○	○	○	○	○	○
印字頭	-	○	○	○	○	○
馬達	-	○	○	○	○	○
液晶顯示器	-	○	○	○	○	○
插座	-	○	○	○	○	○
線材	-	○	○	○	○	○

備考 1. “超出 0.1 wt %” 及 “超出 0.01 wt %” 係指限用物質之百分比含量超出百分比含量基準值。
Note 1 : “Exceeding 0.1 wt %” and “exceeding 0.01 wt %” indicate that the percentage content of the restricted substance exceeds the reference percentage value of presence condition.

備考 2. “○” 係指該項限用物質之百分比含量未超出百分比含量基準值。
Note 2 : “○” indicates that the percentage content of the restricted substance does not exceed the percentage of reference value of presence.

備考 3. “-” 係指該項限用物質為排除項目。
Note 3 : The “-” indicates that the restricted substance corresponds to the exemption.

Contents

1. Introduction	1
1.1 Product Introduction	1
1.2 Product Features	2
1.2.1 Printer Standard Features	2
1.2.2 Printer Optional Features	4
1.3 Printer Specifications	4
1.4 Print Specifications	4
1.5 Ribbon Specifications	5
1.6 Media Specifications	5
2. Operations Overview.....	6
2.1 Unpacking and Inspection	6
2.2 Printer Overview	7
2.2.1 Front View	7
2.2.2 Interior view	9
2.2.3 Rear View	10
2.3 Front Panel Control	12
2.3.1 LED Indication and Keys	12
2.3.2 LCD Main Page Icons (ML240P Series only)	12
3. Setup	14
3.1 Setting up the printer	14
3.2 Loading the Ribbon.....	15
3.3 Remove Used Ribbon.....	18
3.4 Loading the Media	19
3.4.1 Loading the Media	19

3.4.2 Loading the Fanfold/External Media.....	22
3.4.3 Loading Media in Peel-off mode (Option for ML240P Series).....	23
3.4.4 Loading Media in Cutter mode (Option for ML240P Series)	25
4. Adjustment Knob	27
4.1 Print Head Pressure Position Adjustment Knob	27
4.2 Ribbon Tension Adjustment Knob Module.....	28
4.3 Mechanism Fine Adjustment to Avoid Ribbon Wrinkles	29
5. Diagnostic Tool	31
5.1 Start the Diagnostic Tool.....	31
5.2 Printer Function.....	32
5.3 Setting Ethernet by Diagnostic Tool	33
5.3.1 Using USB interface to setup Ethernet interface.....	33
5.3.2 Using RS-232 interface to setup Ethernet interface	34
5.3.3 Using Ethernet interface to setup Ethernet interface.....	35
6. LCD Menu Function (ML240P Series only)	37
6.1 Enter the Menu.....	37
6.2 Menu Overview	38
6.3 Setting.....	39
6.3.1 TSPL	39
6.3.2 ZPL2	41
6.4 Sensor	44
6.5 Interface.....	45
6.5.1 Serial Comm.....	45
6.5.2 Ethernet.....	46
6.5.3 Wi-Fi.....	47
6.5.4 Bluetooth.....	47

6.6 Advanced	48
6.7 File Manager	50
6.8 Diagnostic.....	51
6.9 Favorites	53
7. Troubleshooting	54
8. Maintenance.....	57
Revise History.....	58

1. Introduction

1.1 Product Introduction

Thank you for purchasing TSC bar code printer.

The new high-performance ML240 Series, which have sleek design can deliver the cleanest and high quality barcodes. It features a die-cast aluminum print mechanism housed in a very strong yet lightweight cabinet. This new design results in a more durable printer that is suited for your most heavy-duty demand cycles.

There are four models available with ML240 and ML240P series. The ML240/ ML240P series prints at 203 dpi series are at speeds up to 6 inches per second, ML340/ ML340P series provides higher 300 dpi resolution at speeds up to 5 inches per second, which makes it ideal for printing very small 2D barcodes, graphics, fine print, and other ultra-high-resolution images.

The ML240/ ML240P Series printers are loaded with features including three colors LED bar, two menu buttons, and four navigational keys (ML240P Series only) to provide a great user experience. ML240/ ML240P series support for 450 meters long ribbons, 5.5” O.D. media rolls, USB host for keyboard, USB storage device, and scanner connections.

This manual provides the essential information and clear instructions for operating ML240 series. To print label formats, please refer to the instructions provided with your labeling software. If you need to write the custom programs, please refer to the TSPL/TSPL2 programming manual, which can be found on TSC website at <http://www.tscprinters.com>.

– Applications

- Packing
- Order Fulfillment
- Shipping/ Receiving
- Inventory Management
- Work In Process
- Product Marking
- Compliance Labeling
- Blood Test Tube Label
- Patient Wristband Label
- Product Label
- Event Ticketing

1.2 Product Features

1.2.1 Printer Standard Features

The printer offers the following standard features.

Product standard feature				
Model	ML240	ML340	ML240P	ML340P
Resolution	203 dots/inch (8 dots/mm)	300 dots/inch (12 dots/mm)	203 dots/inch (8 dots/mm)	300 dots/inch (12 dots/mm)
Printing method	Thermal transfer & direct thermal			
Mechanism	High quality die-cast aluminum design			
LCD display/ Operation buttons	<ul style="list-style-type: none"> ■ 2 operation buttons (Pause and Feed) ■ 3 colors LED for notification light bar 		<ul style="list-style-type: none"> ■ 2 operation buttons (The meaning of the buttons will vary depend on the UI footer.) ■ 4 navigational keys ■ 3 colors LED for notification light bar 	
Processor	32-bit RISC high performance processor			
Memory	<ul style="list-style-type: none"> ■ 8MB Flash memory ■ 16MB DRAM 		<ul style="list-style-type: none"> ■ 128MB Flash memory ■ 64MB DRAM 	
Interface	<ul style="list-style-type: none"> ■ USB 2.0 (High speed mode) 		<ul style="list-style-type: none"> ■ USB 2.0 (High speed mode) ■ Internal Ethernet print server (10/100 Mbps) ■ RS-232 (Max. 115,200 bps) ■ USB host: barcode scanner, PC keyboard, and USB storage device 	
Sensors	<ul style="list-style-type: none"> ■ Gap transmissive sensor (Position adjustable, 5mm → 88mm) ■ Black mark reflective sensor (Position adjustable, 0mm → 81.7mm) ■ Ribbon end sensor ■ Head open sensor 		<ul style="list-style-type: none"> ■ Gap transmissive sensor (Position adjustable, 5mm → 88mm) ■ Black mark reflective sensor (Position adjustable, 0mm → 81.7mm) ■ Ribbon end sensor ■ Head open sensor 	
Internal font	<ul style="list-style-type: none"> ■ 8 alpha-numeric bitmap fonts ■ One Monotype Imaging® CG Triumvirate Bold Condensed scalable font ■ Built-in Monotype True Type Font engine 			
Supported code page	<ul style="list-style-type: none"> ■ Codepage 437 (English - US) ■ Codepage 737 (Greek) - ■ Codepage 850 (Latin-1) ■ Codepage 852 (Latin-2) ■ Codepage 855 (Cyrillic) - ■ Codepage 857 (Turkish) ■ Codepage 860 (Portuguese) ■ Codepage 861 (Icelandic) - ■ Codepage 862 (Hebrew) - ■ Codepage 863 (French Canadian) ■ Codepage 864 (Arabic) - ■ Codepage 865 (Nordic) ■ Codepage 866 (Russian) - ■ Codepage 869 (Greek 2) - ■ Codepage 950 (Traditional Chinese) ■ Codepage 936 (Simplified Chinese) ■ Codepage 932 (Japanese) 			

	<ul style="list-style-type: none"> ■ Codepage 949 (Korean) ■ Codepage 1250 (Latin-2) ■ Codepage 1251 (Cyrillic) ■ Codepage 1252 (Latin-1) ■ Codepage 1253 (Greek) ■ Codepage 1254 (Turkish) ■ Codepage 1255 (Hebrew) - ■ Codepage 1256 (Arabic) ■ Codepage 1257 (Baltic) ■ Codepage 1258 (Vietnam) ■ ISO-8859-1: Latin-1 (Western European) ■ ISO-8859-2: Latin-2 (Central European) ■ ISO-8859-3: Latin-3 (South European) ■ ISO-8859-4: Latin-4 (North European) ■ ISO-8859-5: Cyrillic ■ ISO-8859-6: Arabic ■ ISO-8859-7: Greek ■ ISO-8859-8: Hebrew ■ ISO-8859-9: Turkish ■ ISO-8859-10: Nordic ■ ISO-8859-15: Latin-9 ■ UTF-8 	
Supported bar code	1D bar code Code128 subsets A.B.C, Code128UCC, EAN128, Interleave 2 of 5, Code 39, Code 93, EAN-13, EAN-8, Codabar, Standard 2 of 5, Industrial 2 of 5, POSTNET, UPC-A, UPC-E, EAN and UPC 2(5) digits add-on, MSI, PLESSEY, China Post, ITF14, EAN14, Code 11, TELPEN, PLANET, Code 49, Deutsche Post Identcode, Deutsche Post Leitcode, LOGMARS, RSS-Stacked, GS1 DataBar.	2D bar code CODABLOCK F mode, DataMatrix, Maxicode, PDF-417, Aztec, MicroPDF417, QR code, RSS Barcode (GS1 Databar), TLC 39, RSS
Command set	TSPL-EZD™	
Font & bar code rotation	0, 90, 180, 270 degree	
Others	<ul style="list-style-type: none"> ■ Standard industry emulations right out of the box including Eltron® and Zebra® language support ■ Built-in Monotype True Type Font engine ■ Downloadable fonts from PC to printer memory 	

1.2.2 Printer Optional Features

The printer offers the following optional features.

Product option features					
	ML240/ ML340		ML240P/ ML340P		
	User option	Factory option	User option	Dealer option	Factory option
KP-200 Plus keyboard display unit			○		
Internal Bluetooth 4.2 MFi module in front panel		○			○
Wi-Fi module without slot-in housing				○	
Wi-Fi module with slot-in housing			○		
Regular guillotine cutter module (Max. print speed: 4 ips/ Media thickness: 0.06 ~ 0.28 mm/ Media type: receipt, tag, and label liner w/o glue)				○	
Peel off module				○	
Cutter tray			○		

Note: 1. Option for either Wi-Fi or Bluetooth only, not coexistence.

2. Except for the linerless cutter, all TSC regular/heavy duty/care label cutters DO NOT cut on media with glue.

1.3 Printer Specifications

Printer Specifications				
Model	ML240	ML340	ML240P	ML340P
Physical dimensions	248 (W) x 245 (H) x 330 (D) mm			
Weight	7.4 kg		7.6 kg	
Power	Auto sensing power supply (20% print ratio) ■ Input: AC 100-240V, 1.5A, 50/ 60Hz ■ Output: DC 24V, 2.5A; 60W			
Environmental condition	■ Operation: 5°C ~ 40°C (41 ~ 104°F), 25%~85% non-condensing ■ Storage: -40°C ~ 60°C (-40 ~ 140°F), 10%~90% non-condensing		■ Operation: 0°C ~ 40°C (32 ~ 104°F), 25%~85% non-condensing	
Environmental concern	Comply with Energy Star 2.0, REACH, RoHS, and WEEE			

1.4 Print Specifications

Print Specifications	203 dpi models	300 dpi models
Print head resolution (dots per inch/mm)	203 dots/inch (8 dots/mm)	300 dots/inch (12 dots/mm)
Printing method	Thermal transfer and direct thermal	

Dot size (width x length)	0.125 x 0.125 mm (1 mm = 8 dots)	0.084 x 0.084 mm (1 mm = 12 dots)
Print speed (inches per second)	1, 2, 3,...6 ips Up to 6 ips	1, 2, 3,...5 ips Up to 5 ips
Max. print width	108 mm (4.25")	105.7 mm (4.16")
Max. print length	ML240: 110" (2,794 mm) ML240P: 1000" (25,400 mm)	ML340: 40" (1,016 mm) ML340P: 450" (11,430 mm)
Printout bias	Vertical: Max. 1 mm. Horizontal: Max. 1 mm	

1.5 Ribbon Specifications

Ribbon Specifications	
Ribbon outside diameter	Max. 81.3 mm O.D.
Ribbon capacity	450 meter long
Ribbon core	1" (25.4 mm)
Ribbon width	40 mm ~ 110 mm (1.57" ~ 4.33")
Ribbon wound type	Ink coated inside/ outside wound

Note: It is recommended to use the ribbon width wider than label width.

1.6 Media Specifications

Media Specifications	
Media roll capacity	5.5" O.D; 1" or 1.5" I.D core
Media core diameter	1" or 1.5" (25.4 mm or 38.1 mm) I.D. core
Media type	Continuous, die-cut, black mark, fan-fold, and notch
Media wound type	Outside wound
Media width	20 mm ~ 118 mm (0.79" ~ 4.65") 20 mm ~ 114.3 mm (0.79" ~ 4.5") for peeler/ cutter mode
Media thickness	0.06 mm ~ 0.19 mm
Label length	<ul style="list-style-type: none"> ▪ 5 mm ~ 25,400 mm (203 dpi series) ▪ 5 mm ~ 11,430 mm (300 dpi series)
Label length (peeler mode)	25.4mm ~ 152.4mm (1" ~ 6")
Label length (cutter mode)	<ul style="list-style-type: none"> ▪ 25.4~2,794 mm (1" ~ 110") for 203dpi series ▪ 25.4~1,016 mm (1" ~ 40") for 300dpi series
Black mark	Min. 8 mm (W) x Min. 2 mm (H)
Gap height	Min. 2 mm

2. Operations Overview

2.1 Unpacking and Inspection

This printer has been specially packaged to withstand damage during shipping. Please carefully inspect the packaging and printer upon receiving the bar code printer. Please retain the packaging materials in case you need to reship the printer.

Unpacking the printer, the following items are included in the carton.

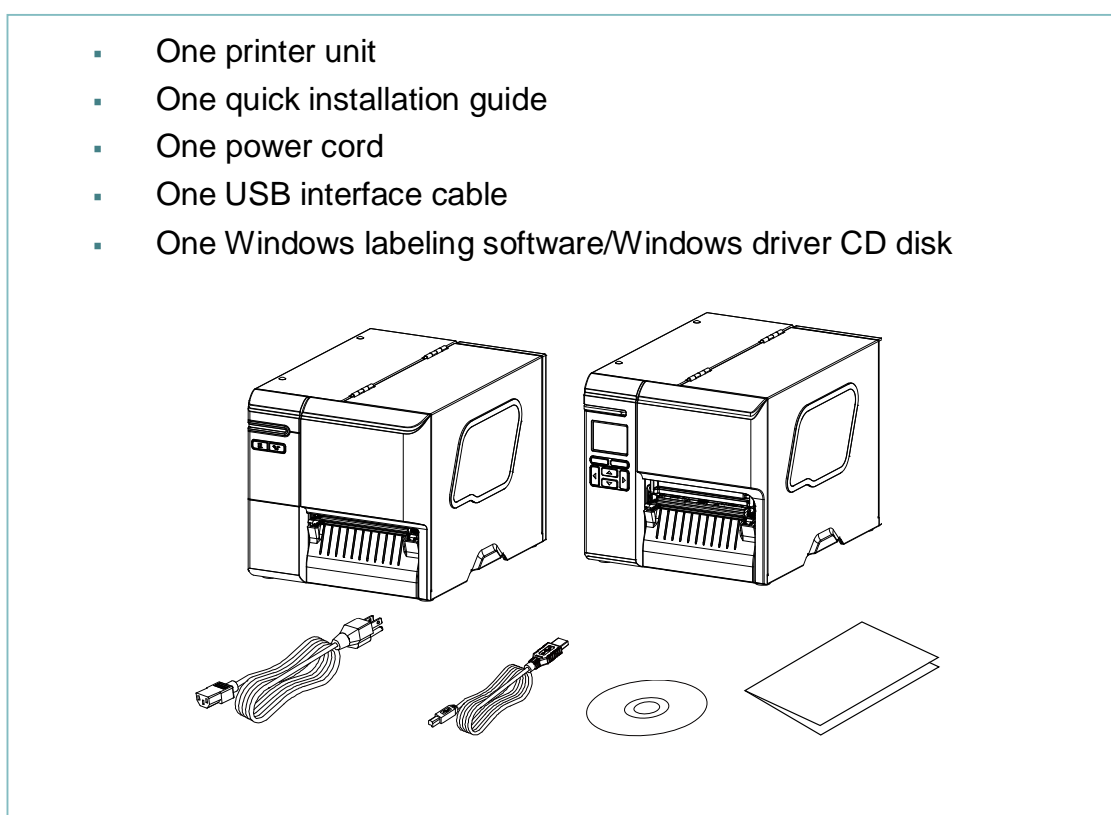

If any parts are missing, please contact the Customer Service Department of your purchased reseller or distributor.

Note: Check the production date

Serial NO.: XXX 17 22 XXXX

YEAR WEEK



Год



Неделю

2.2 Printer Overview

2.2.1 Front View

For ML240 Series



1. LED indicator
2. Front panel buttons with icons
3. Media view window
4. Paper exit chute
5. Media cover handle

For ML240P Series



- 1.** LED indicator
- 2.** LCD display
- 3.** Front panel buttons
- 4.** Media view window
- 5.** Paper exit chute
- 6.** Media cover handle

2.2.2 Interior view

For ML240/ ML240P Series



2.2.3 Rear View

For ML240 Series



1. External label entrance chute
2. Power switch
3. USB interface (High speed mode)
4. Power cord socket

Note:
The interface picture here is for reference only. Please refer to the product specification for the interfaces availability.

For ML240P Series

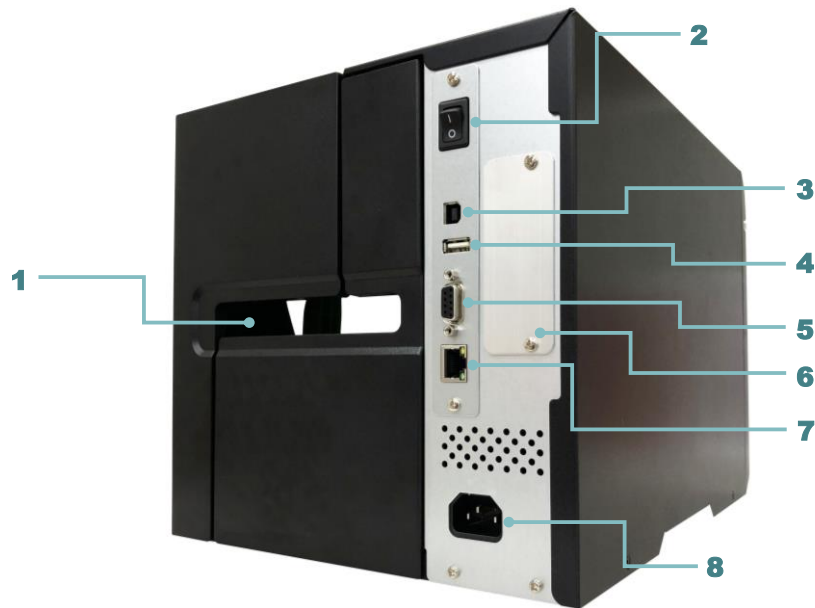





1. External label entrance chute
2. Power switch
3. USB interface (High speed mode)
4. USB host
5. RS-232 interface
6. Slot-in Wi-Fi interface (Option)
7. Ethernet interface
8. Power cord socket





Note:
The interface picture here is for reference only. Please refer to the product specification for the interfaces availability.

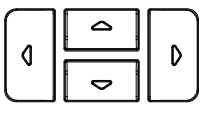



2.3 Front Panel Control

2.3.1 LED Indication and Keys

LED	Status	Indication	
	Green	Solid	This illuminates that the power is on and the device is ready to use.
		Flash	This illuminates that the system is downloading data from PC to memory and or printer is paused.
	Amber	This illuminates that the system is clearing data from printer.	
	Red	Solid	This illuminates printer head open, cutter error, and carriage open.
Flash		This illuminates a printing error, such as paper empty, paper jam, ribbon empty, or memory error etc.	
For ML240 Series			
Keys	Function		
 Pause Key	Pause/ Resume the printing process.		
 Feed Key	Advance one label.		
For ML240P Series			
 Select keys	The labels on the footer of the UI will explain the function for left and right soft key. Check the labels on the footer of the UI screen. The meaning of the select keys will vary.		
 Navigational keys	Used to select icons, menu selection, and navigation in the UI.		

2.3.2 LCD Main Page Icons (ML240P Series only)

Indicated icon	Indication
	Wi-Fi device is ready (option)
	Ethernet is connected
	Bluetooth device is ready (option)
	Media capacity %
	Ribbon capacity %

	Security lock
Icon button	Function
	Enter the menu
	Enter cursor (be marked in green) located option
	Feed button (advance one label)

3. Setup

3.1 Setting up the printer

1. Place the printer on a flat, secure surface.
2. Make sure the power switch is off.
3. Connect the printer to the computer with the provided USB cable.
4. Plug the power cord into the AC power cord socket at the rear of the printer, and then plug the power cord into a properly grounded power outlet.

Note: Please switch **OFF** printer power switch prior to plug in the power cord to printer power jack.

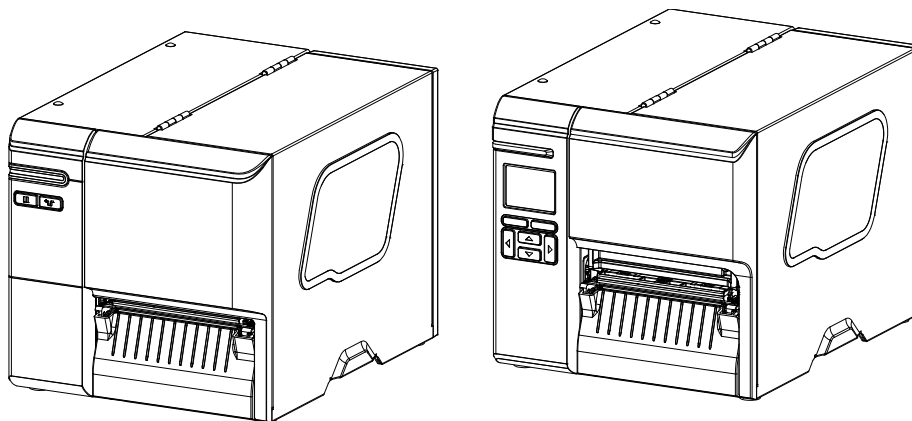

3.2 Loading the Ribbon



1. Open the printer right side cover.

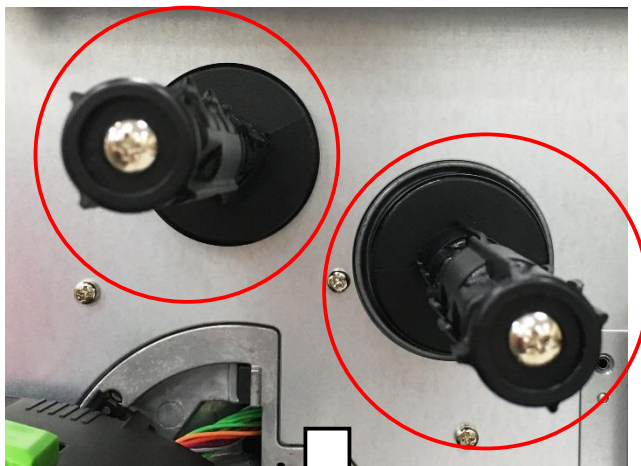

2. Install the ribbon onto ribbon supply spindle and install paper core onto ribbon rewind spindle.

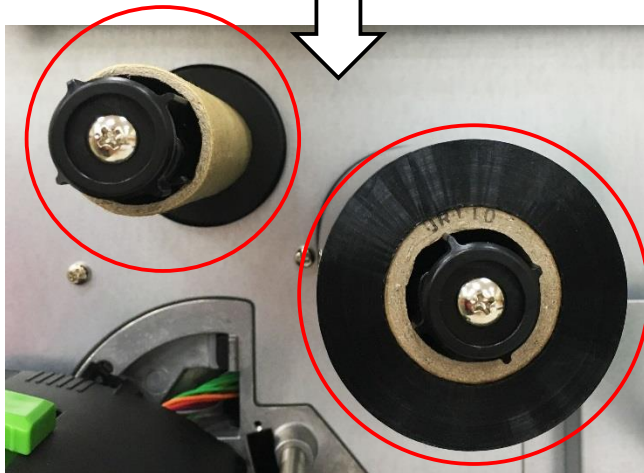

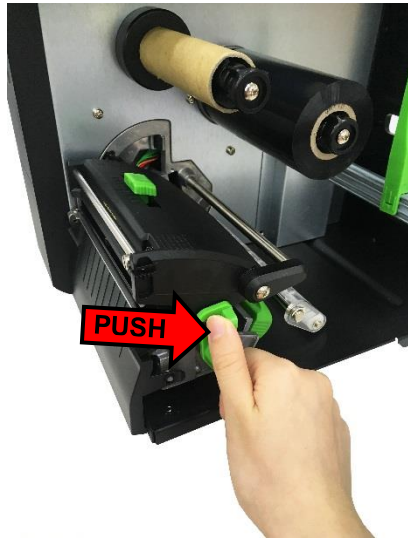

3. Push the Print head release lever to open Print head mechanism.

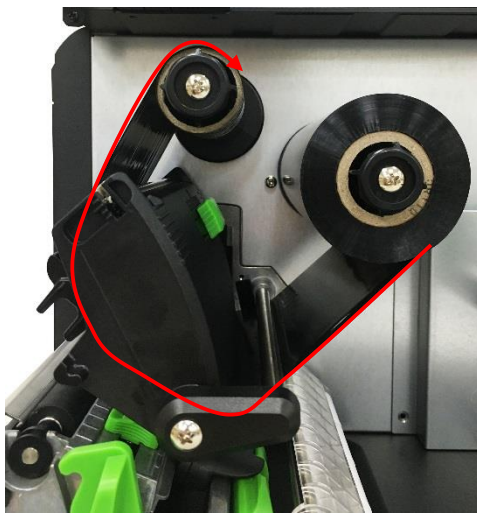

4. Thread ribbon below the ribbon guide bar through ribbon sensor slot as the loading path printed on the printer.

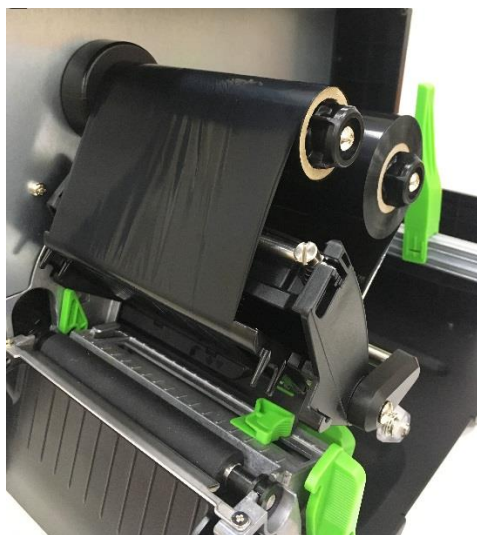
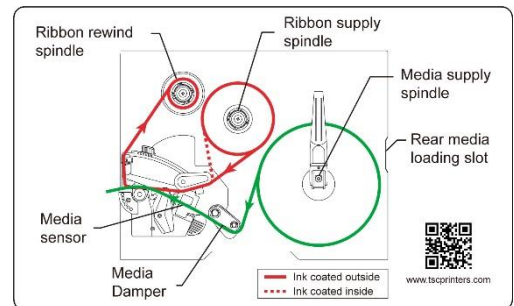

5. Stick the ribbon leader onto the paper core. Keep the ribbon flat and without wrinkle.

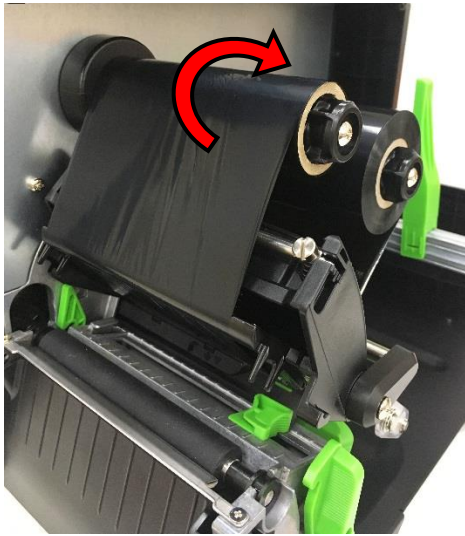

6. Wind the ribbon rewind spindle clockwise roughly 3~5 circles until the ribbon is smooth, properly stretched and wrinkle-free.



7. Close the print head mechanism by pushing down the both sides of the print head release lever.

Note:

* Please refer to video on [TSC YouTube](#).

Ribbon loading path

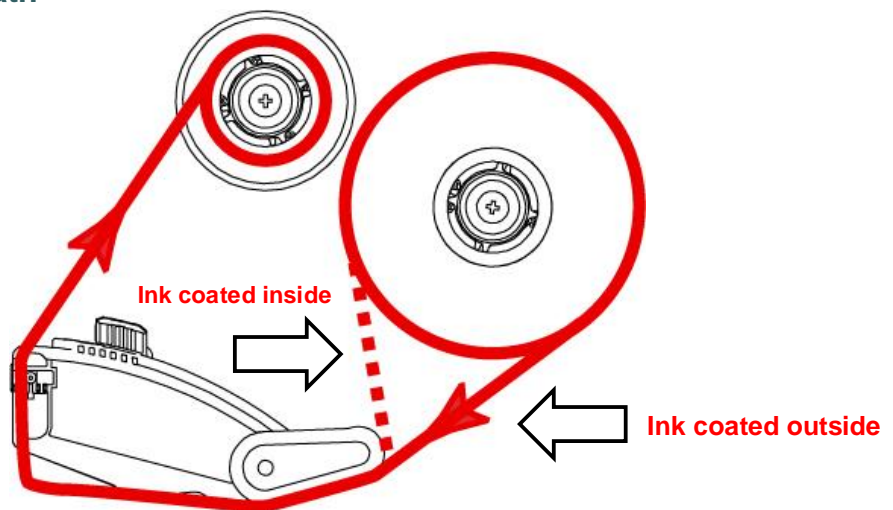

3.3 Remove Used Ribbon

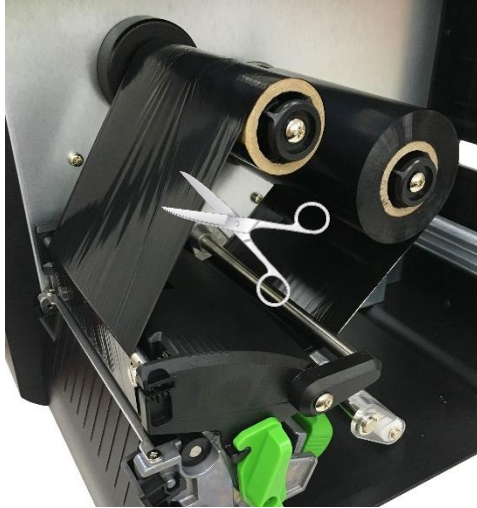

1. Break the ribbon between ribbon guide plate and the ribbon rewind spindle.

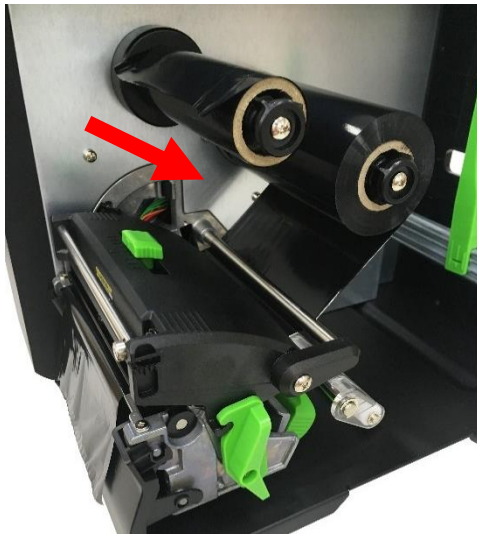

2. Slide the used ribbon off to release the ribbon on the ribbon rewind spindle.

3.4 Loading the Media

3.4.1 Loading the Media



1. Open the printer right side cover.

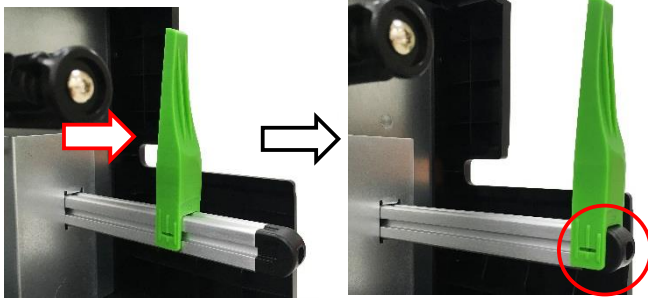

2. Move the label roll guard horizontally to the end of label spindle, then flip down the label roll guard.

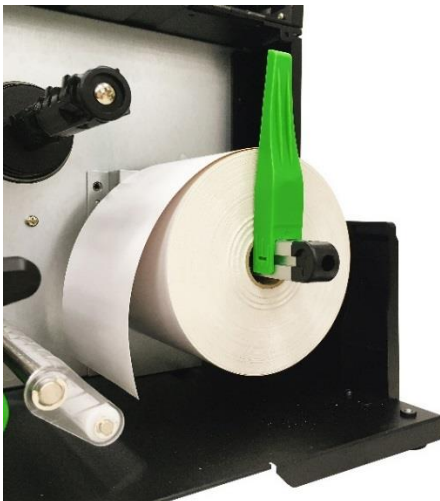
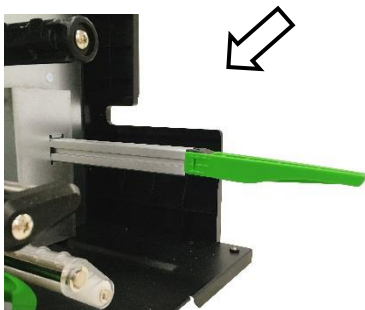

3. Place the media roll on the label supply spindle and use label roll guard to fix it.



4. Push the print head release lever and install the label through the damper, media sensor, and label guide to install the media.

5. Move the media sensor by adjusting the media sensor position adjustment knob, make sure the gap or black mark sensor is at the location where media gap/black mark will pass through for sensing.

Black mark sensor
(shown as ↓)

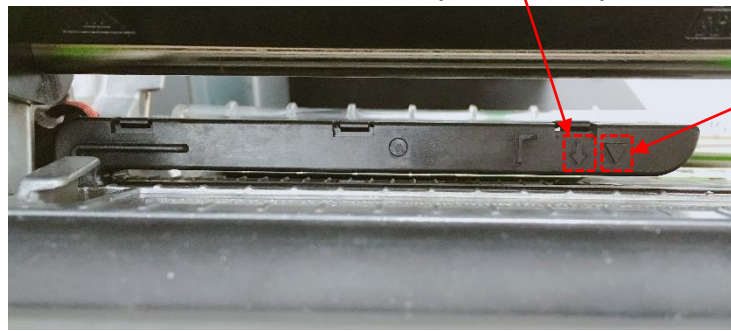

Gap sensor
(shown as ▽)

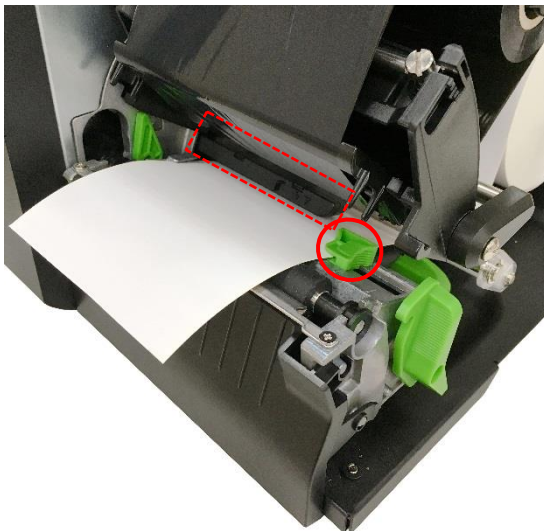

6. Adjust the label guide to fix the media position.

Note:

*Please install the media through the media sensor.

* The sensor location is marked by a triangle mark ▽ (gap sensor) and arrow mark ↓ (black mark sensor) at the sensor housing.

*The media sensor position is movable. Please make sure the gap or black mark is at the location where media gap/black mark will pass through for sensing.

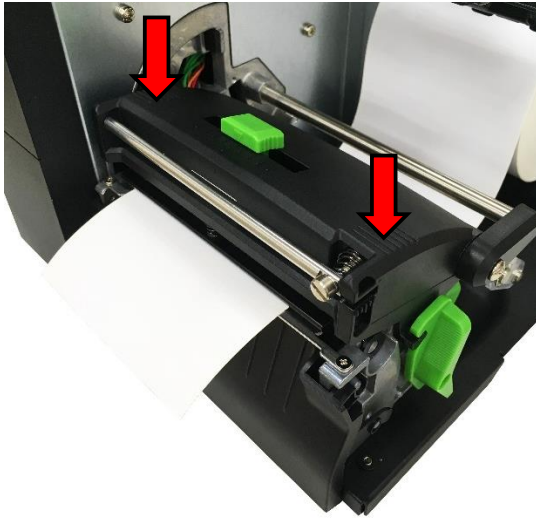

7. Close the print head mechanism on both sides and make sure the latches had engaged securely.
8. Set media sensor type and calibrate the selected sensor.

Note:

* When installing label with 1 to 2 inches width, please adjust Print Head Pressure Position Adjustment Knob to left side.



*Please calibrate the gap/black mark sensor when changing media.

*Please refer to video on [TSC YouTube](#).

3.4.2 Loading the Fanfold/External Media



1. Open the printer right side cover.
2. Insert the fanfold media through the rear external label entrance chute.
3. Please refer to section 3.4.1 step 4–8 for loading media.

Note:

Please calibrate the gap/black mark sensor when changing media.

Loading path for fan-fold labels

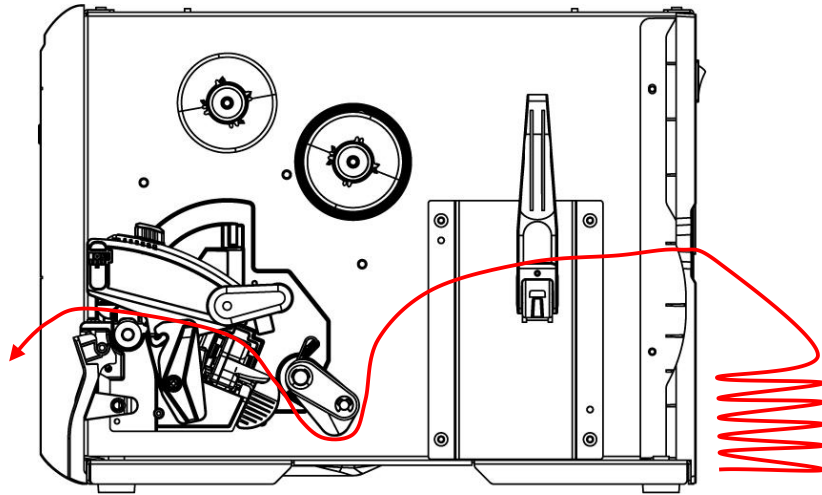

3.4.3 Loading Media in Peel-off mode (Option for ML240P Series)



1. Open the printer right side cover.
2. Please refer to section 3.4.1 for loading the media.



3. Using the front display panel to do the calibration first and set the printer mode to Peeler mode.

Note:

1. Please calibrate the gap/black mark sensor before loading media in the peel-off mode to avoid the paper jam.
2. Please feed the label through media guide bar as picture shown.

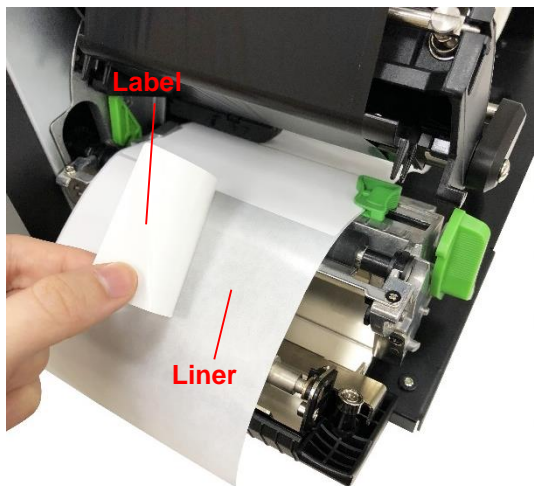

4. Open print head release lever and peel-off module, pull approximately 650 mm of the label through the front of the printer.
5. Remove several labels to leave liner.

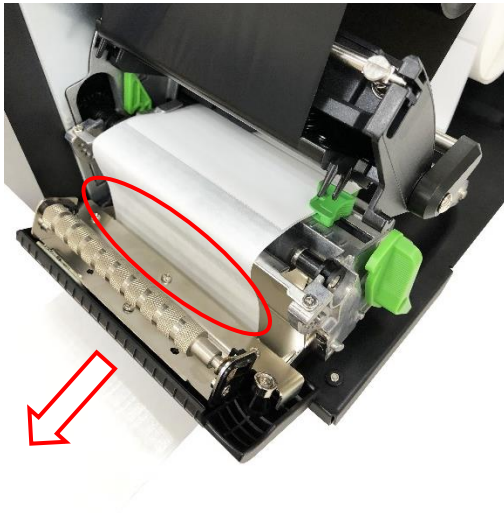

6. Feed the leading edge of liner through the peel-off module slot as indicated.



7. Close print head release lever and peel-off module. Next, close printer right side cover.
8. Press the FEED button to test.

3.4.4 Loading Media in Cutter mode (Option for ML240P Series)



1. Open the printer right side cover.
2. Please refer to section 3.4.1 for loading the media.



3. Using the front display panel to do the calibration first and set the printer mode to Cutter mode.

Note:

1. Please calibrate the gap/black mark sensor before loading media in the peel-off mode to avoid the paper jam.
2. Please feed the label through media guide bar as picture shown.

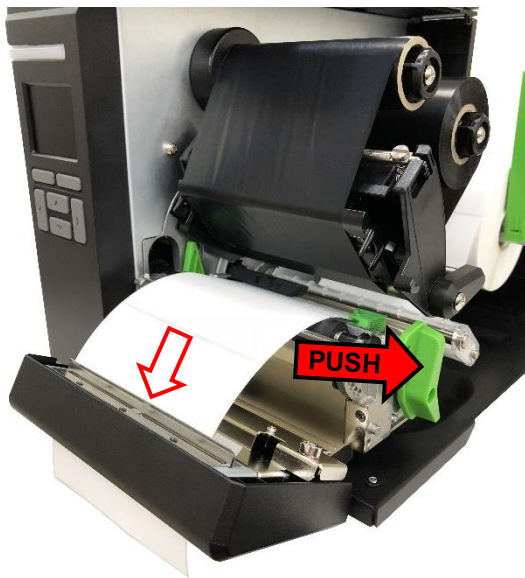

4. Push the Print head release lever to open print head mechanism and open the Cutter module. Lead the media through the cutter paper opening as indicated.



5. Close the print head mechanism and cutter module.
6. Press the FEED button to test.

4. Adjustment Knob

4.1 Print Head Pressure Position Adjustment Knob

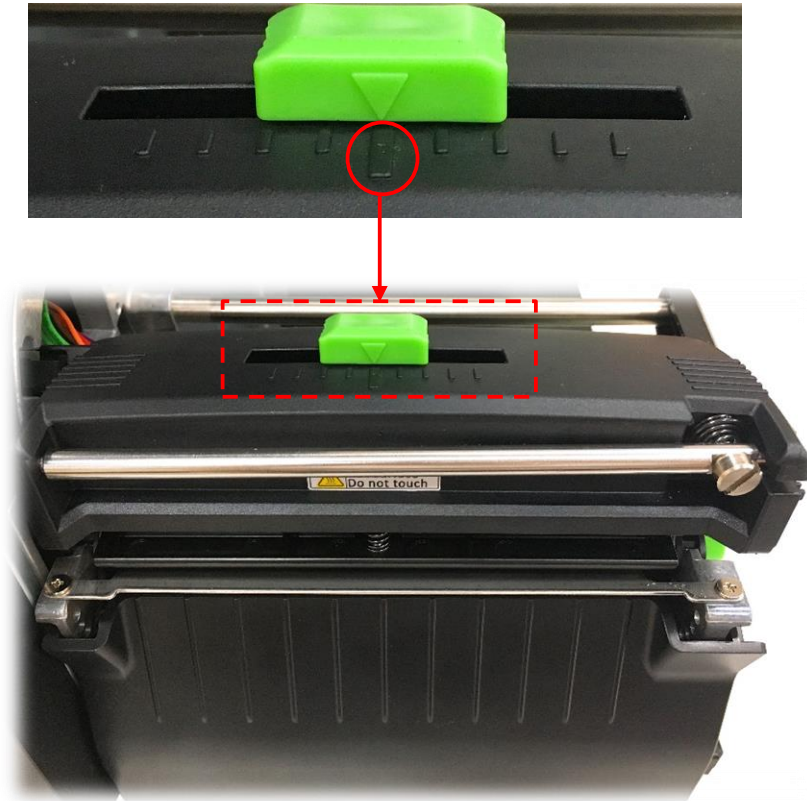

The print head pressure adjustment knob has nine positions from left to right. Because the printer's paper alignment is to the left side of mechanism, different media widths require the different pressure to print the label correctly. Therefore, it may require adjusting pressure position to get the best print quality.

4.2 Ribbon Tension Adjustment Knob Module

Ribbon Tension Adjustment Knob has five positions for adjustment. Because the printer's ribbon alignment is to the left side of mechanism, different ribbon or media widths require different ribbon tension to print correctly. Therefore, it may require adjust the ribbon tension adjustment knob to avoid wrinkle and get the best print quality.

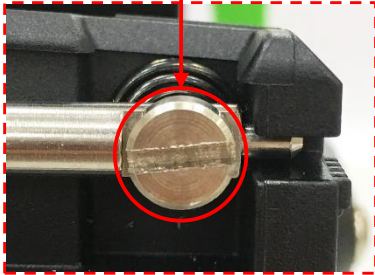
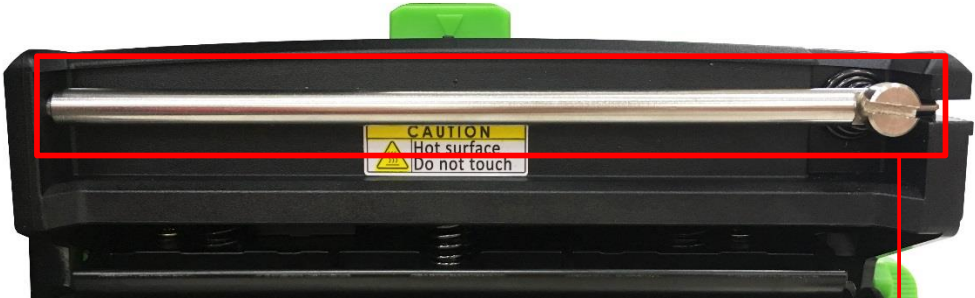

Ribbon Tension Adjustment Knob

4.3 Mechanism Fine Adjustment to Avoid Ribbon Wrinkles

This printer has been thoroughly tested before delivery. There should be no ribbon wrinkle presented on the media for general-purpose printing application. Ribbon wrinkle is related to the media width, thickness, print head pressure balance, ribbon film characteristics, print darkness setting...etc. In case the ribbon wrinkle happens, please follow the instructions below to adjust the printer parts.

<p>Adjustable Printer Parts</p>	<p>Ribbon Tension Adjustment Knob has five positions for adjustment. Use flat blade driver to change the ribbon tension position.</p> <div style="display: flex; justify-content: space-around;">   </div> <p style="display: flex; justify-content: space-around;"> Ribbon Tension Adjustment scales Ribbon Tension Adjustment Knob </p>	
<p>Symptom</p>	<p>1. Wrinkle happens from label lower right to upper left direction (“ ` ”)</p>	<p>2. Wrinkle happens from label lower left to upper right direction (“ ’ ”)</p>
<p>Wrinkle Example</p>	<div style="display: flex; align-items: center; justify-content: center;"> <div style="border: 1px solid black; padding: 5px; margin-right: 20px;">  </div> <div style="text-align: center; margin-right: 20px;">  <p>Feed direction</p> </div> <div style="border: 1px solid black; padding: 5px; margin-left: 20px;">  </div> </div>	

If the wrinkle on the label starts from the lower right side to upper left side, please do following adjustment.

1. Switch the ribbon tension adjustment knob clockwise per 1 level and print the label again to check if the wrinkle is gone.



2. If the ribbon tension adjustment knob has positioned on the level of innermost side but didn't improve the ribbon wrinkle, please switch the print head pressure adjustment knob per 1 level and print the label again to check if the wrinkle is gone.
3. If the wrinkle can't be avoided, please contact the Customer Service Department of your purchased reseller or distributor for service.

If the wrinkle on the label starts from the lower left side to upper right side, please do following adjustment.

1. Switch the ribbon tension adjustment knob counterclockwise per 1 level and print the label again to check if the wrinkle is gone.

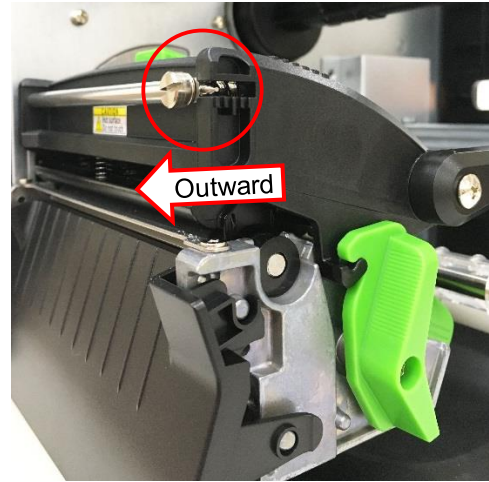

2. If the ribbon tension adjustment knob has positioned on the level of outermost side but didn't improve the ribbon wrinkle, please switch the print head pressure adjustment knob per 1 level and print the label again to check if the wrinkle is gone.
3. If the wrinkle can't be avoided, please contact the Customer Service Department of your purchased reseller or distributor for service.

5. Diagnostic Tool

TSC's Diagnostic Utility is an integrated tool incorporating features that enable you to explore a printer's settings/status; change a printer's settings; download graphics, fonts, and firmware; create a printer bitmap font; and send additional commands to a printer. With the aid of this powerful tool, you can review printer status and setting in an instant, which makes it much easier to troubleshoot problems and other issues.

5.1 Start the Diagnostic Tool

1. Double click on the Diagnostic tool icon   to start the software.
2. There are four features (Printer Configuration, File Manager, Bitmap Font Manager, Command Tool) included in the Diagnostic utility.

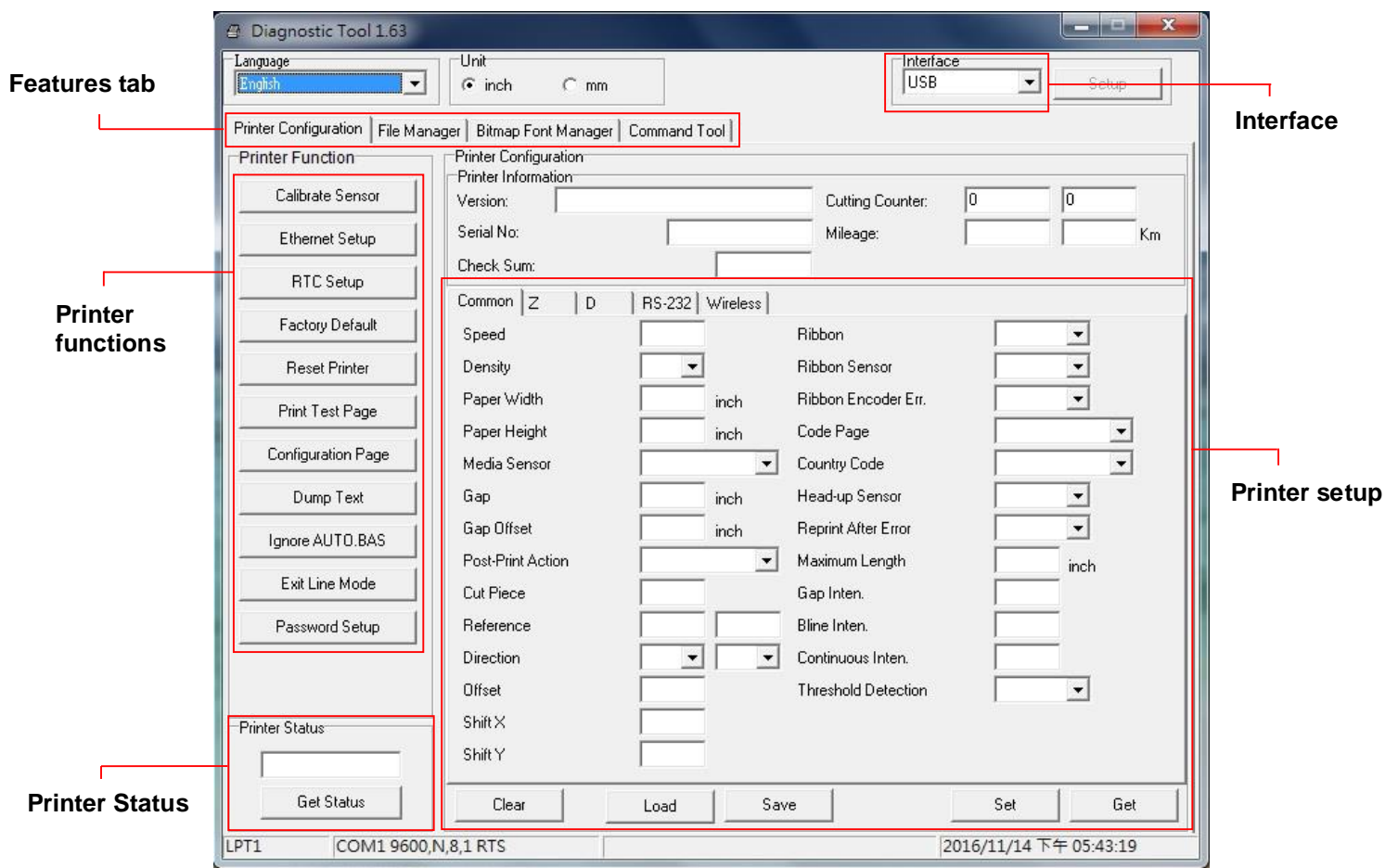

5.2 Printer Function

1. Connect the printer and computer with a cable.
2. Select the PC interface connected with bar code printer.

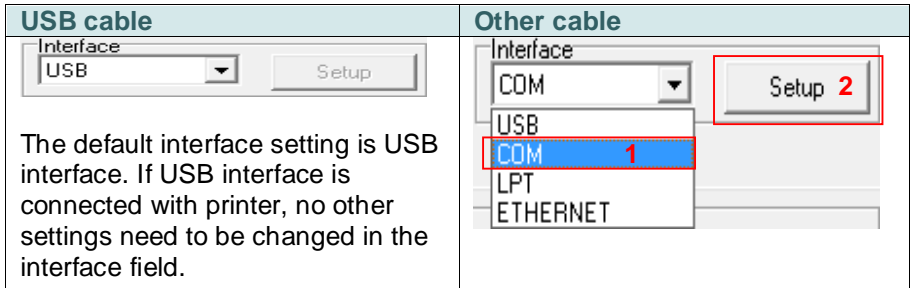

3. Click the "Printer Function" button to setup.
4. The detail functions in the Printer Function Group are listed as below.

Printer Function	Function	Description
Calibrate Sensor	Calibrate Sensor	Calibrate the sensor specified in the Printer Setup group media sensor field
Ethernet Setup	Ethernet Setup	Setup the IP address, subnet mask, gateway for the on board Ethernet
RTC Setup	RTC Setup	Synchronize printer Real Time Clock with PC
Factory Default	Factory Default	Initialize the printer and restore the settings to factory default.
Reset Printer	Reset Printer	Reboot printer
Print Test Page	Print Test Page	Print a test page
Configuration Page	Configuration Page	Print printer configuration
Dump Text	Dump Text	To activate the printer dump mode.
Ignore AUTO.BAS	Ignore AUTO.BAS	Ignore the downloaded AUTO.BAS program
Exit Line Mode	Exit Line Mode	Exit line mode.
Password Setup	Password Setup	Set the password to protect the settings

For more information about Diagnostic Tool, please refer to the diagnostic utility quick start guide in TSC official website Downloads \ Manuals \ Utilities \ Diagnostic utility quick start guide.

5.3 Setting Ethernet by Diagnostic Tool

The Diagnostic Utility is enclosed in the CD disk \ Utilities directory. Users can use Diagnostic Tool to setup the Ethernet by RS-232, USB and Ethernet interfaces. The following contents will instruct users how to configure the Ethernet by these three interfaces.

5.3.1 Using USB interface to setup Ethernet interface

1. Connect the printer and computer with USB cable.
2. Turn on the printer power switch.
3. Start the Diagnostic Utility by double clicking on the  icon.
4. The Diagnostic Utility default interface setting is USB interface. If USB interface is connected with printer, no other settings need to be changed in the interface field.

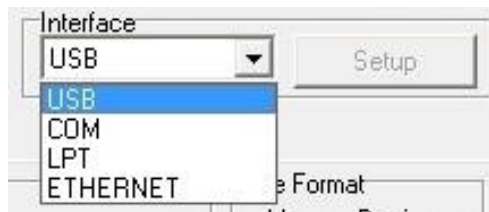

5. Click on the “Ethernet Setup” button from “Printer Function” group in Printer Configuration tab to setup the IP address, subnet mask and gateway for the on board Ethernet.

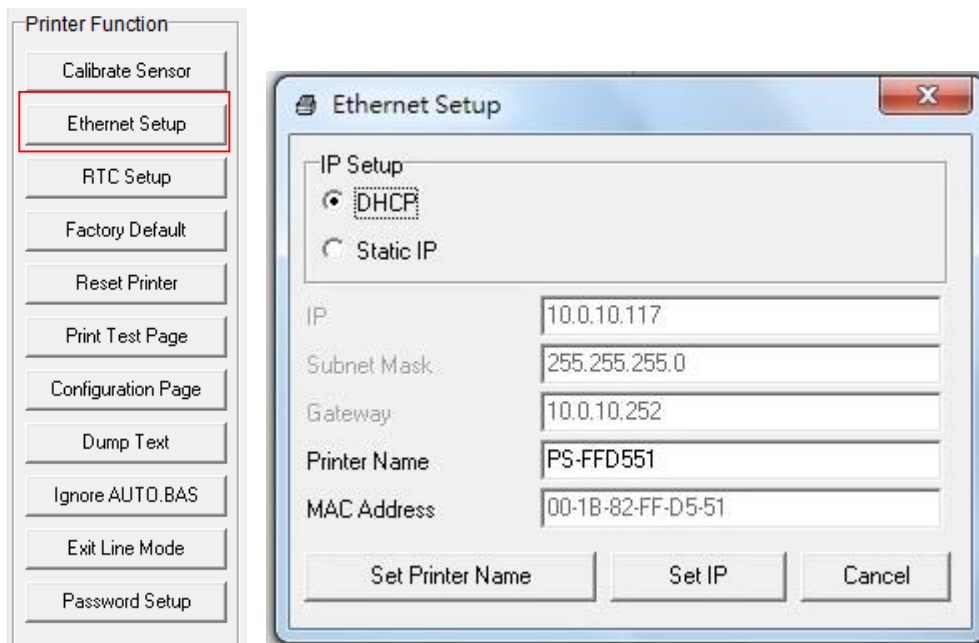

5.3.2 Using RS-232 interface to setup Ethernet interface

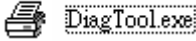
1. Connect the computer and the printer with a RS-232 cable.
2. Turn on the printer power.
3. Start the Diagnostic Utility by double clicks on the  icon.
4. Select “COM” as interface then click on the “Setup” button to setup the serial port baud rate, parity check, data bits, stop bit and flow control parameters.

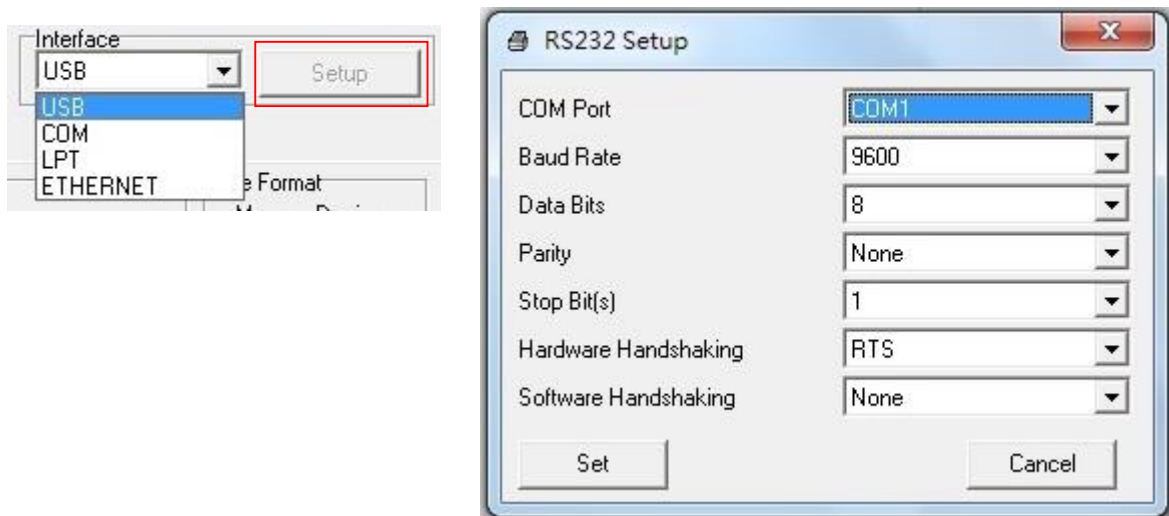

5. Click on the “Ethernet Setup” button from printer function of Printer Configuration tab to setup the IP address, subnet mask and the gateway for the on board Ethernet.

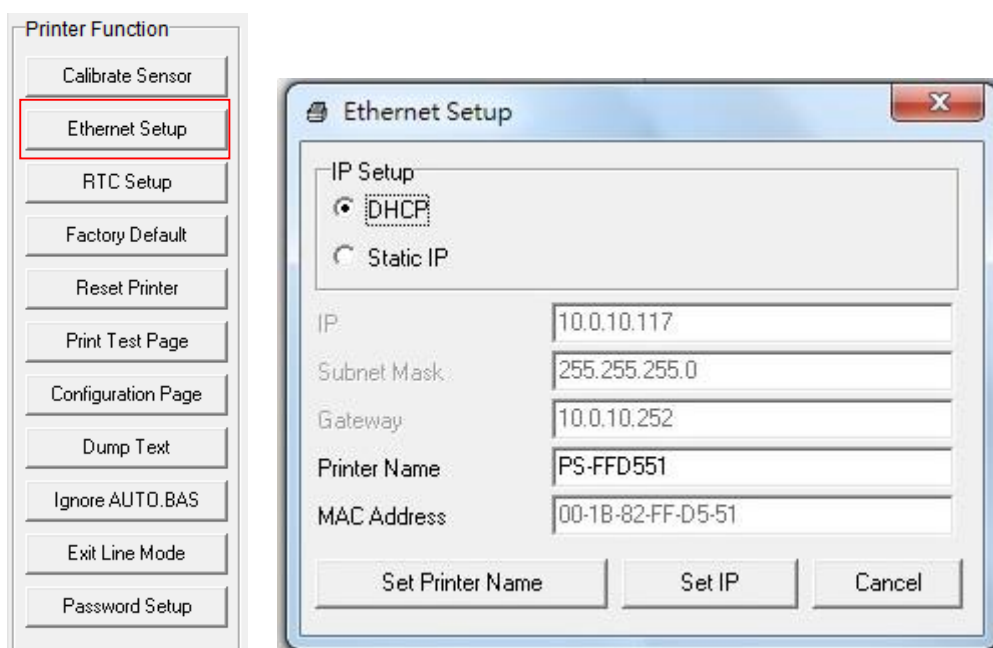

5.3.3 Using Ethernet interface to setup Ethernet interface

1. Connect the computer and the printer to the LAN.
2. Turn on the printer power.
3. Start the Diagnostic Utility by double clicks on the  **DiagTool.exe** icon.
4. Select “Ethernet” as the interface then click on the “Setup” button to setup the IP address, subnet mask and gateway for the on board Ethernet.

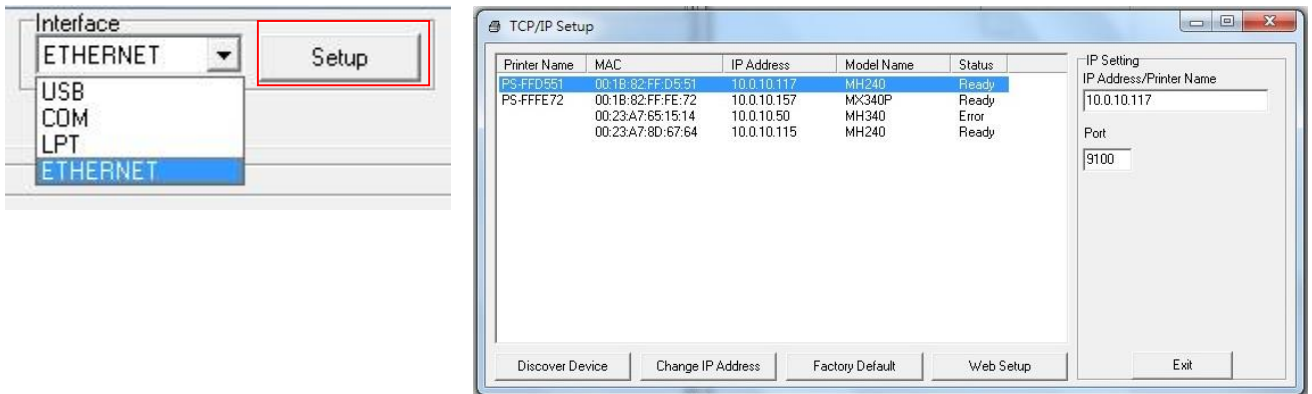

5. Click the “Discover Device” button to explore the printers that exist on the network.
6. Select the printer in the left side of listed printers, the correspondent IP address will be shown in the right side “IP address/Printer Name” field.
7. Click “Change IP Address” to configure the IP address obtained by DHCP or static.

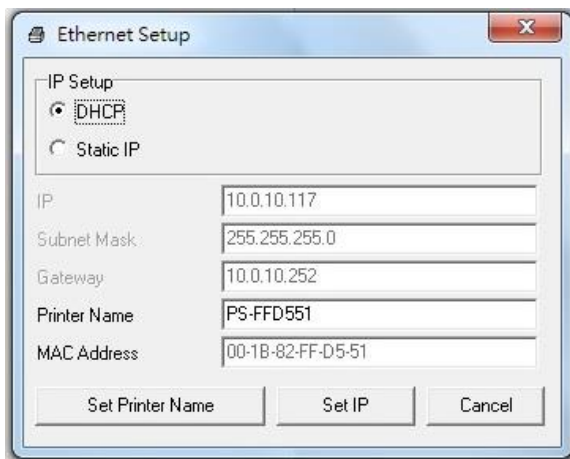

The default IP address is obtained by DHCP. To change the setting to static IP address, click “Static IP” radio button then enter the IP address, subnet mask and gateway. Click “Set IP” to take effect the settings.

Users can also change the “Printer Name” by another model name in this field then click “Set Printer Name” to take effect this change.

Note: After clicking the “Set Printer Name” or “Set IP” button, printer will reset to take effect the settings.

8. Click “Exit” button to exit the Ethernet interface setup and go back to Diagnostic Tool main screen.

“Factory Default” button

This function will reset the IP, subnet mask, gateway parameters obtained by DHCP and reset the printer name.

“Web setup” button



Except to use the Diagnostic Utility to setup the printer, you can also explore and configure the printer settings and status or update the firmware with the IE or Firefox web browser. This feature provides a user friendly setup interface and the capability to manage the printer remotely over a network.

6. LCD Menu Function (ML240P Series only)

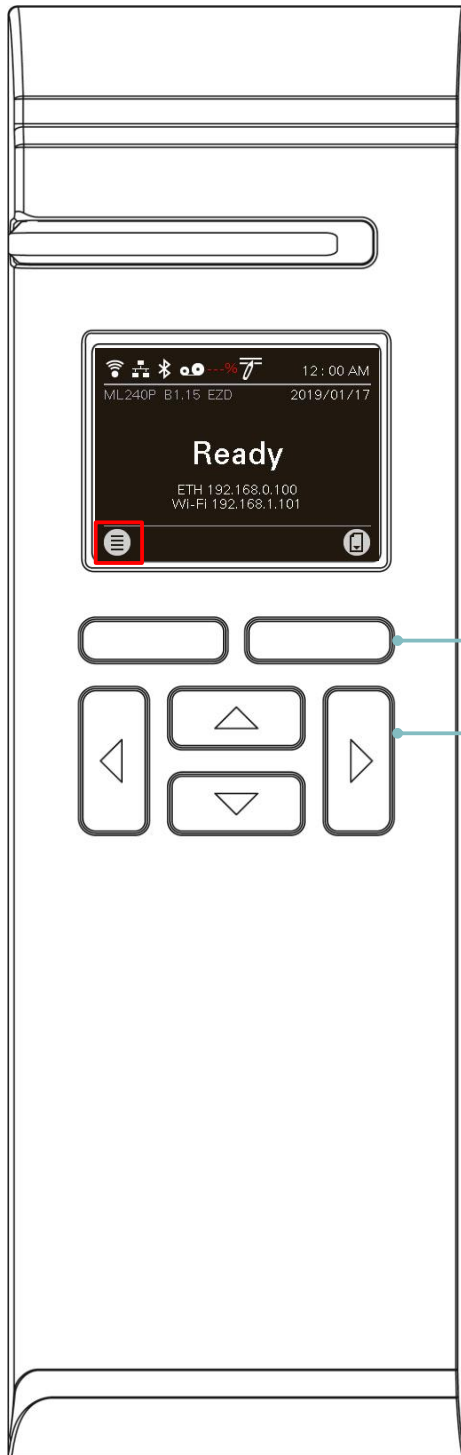
6.1 Enter the Menu



* By Keys:

Use Select keys to select the 
“Menu” icon and press the right select
key button (means ) to enter
each function.

Note: If the main menu button with
locked sign, please input password to
unlock the screen.

Select keys

Navigational keys

6.2 Menu Overview

There are 6 categories for the menu. You can easily set the settings of the printer without connecting the computer. Please refer to following sections for more details.



This "Setting" category can set up the printer settings for TSPL & ZPL2.



This "Sensor" option is used to calibrate the selected media sensor. We recommend calibrate the sensor before printing when changing the media.

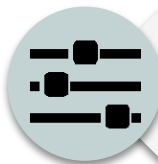

This "Interface" option is used to set the printer interface settings.

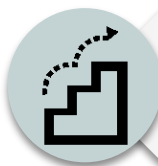

This "Advanced" option is used to set the printer LCD settings, initialization, cutter type, media low warning setting %...etc.



This "File Manager" option is used to check/manager the printer available memory.



This "Diagnostic" option is used to review printer to troubleshoot problems and other issues.

6.3 Setting

Choose the “Command Set” item on LCD and switch the TSPL and ZPL2 by press right select key.

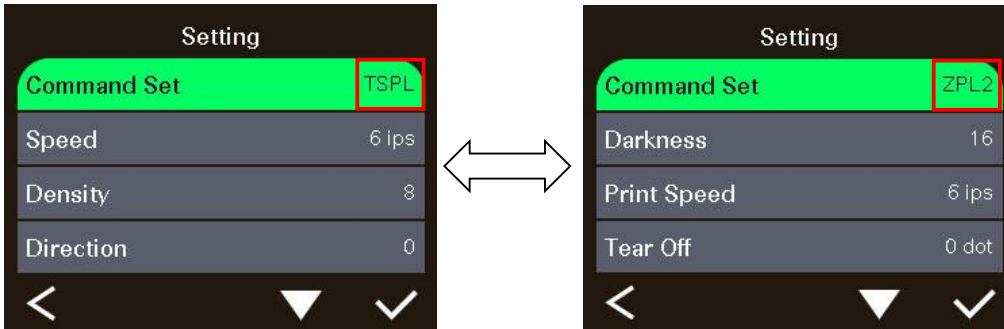

6.3.1 TSPL

This “TSPL” category can set up the printer settings for TSPL.

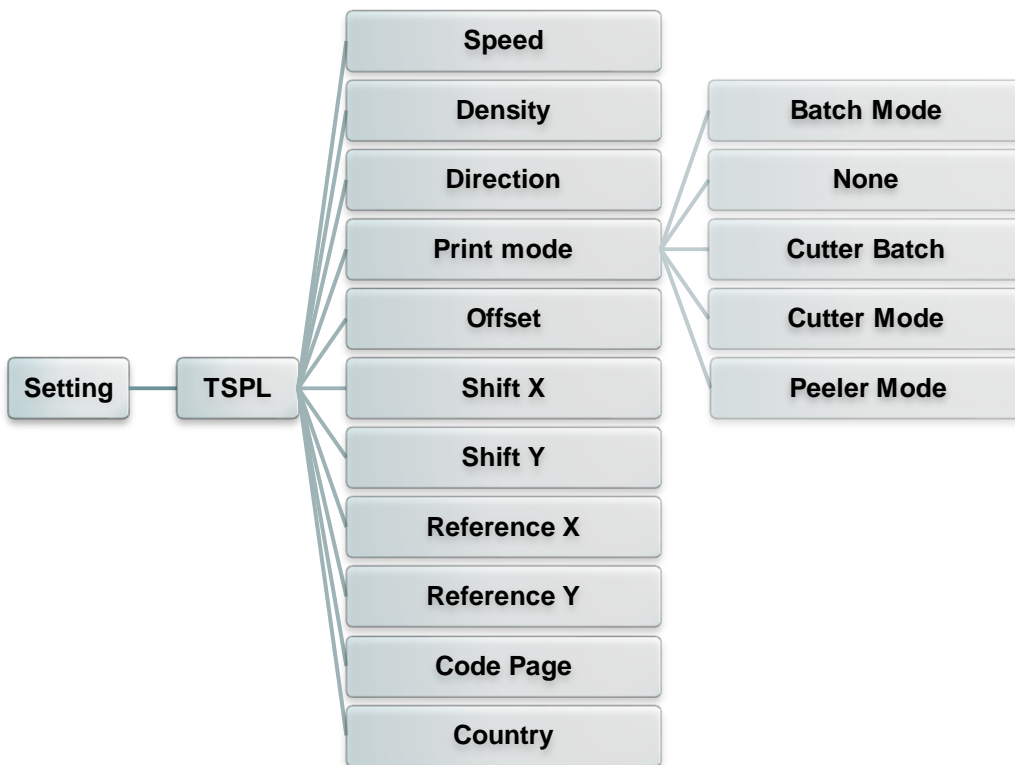

Item	Description	Default
Speed	Use this item to setup print speed. Available setting range is 1~6 for 203dpi and 1~5 for 300dpi.	203 dpi: 5 300 dpi: 3
Density	Use this option to setup printing darkness. The available setting range is from 0 to 15, and the step is 1. You may need to adjust your density based on selected media.	8

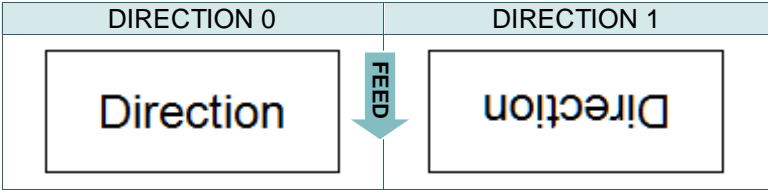
Direction	<p>The direction setting value is either 1 or 0. Use this item to setup the printout direction.</p> 	0												
Print mode	<p>This item is used to set the print mode. There are 5 modes as below,</p> <table border="1" data-bbox="416 573 1259 902"> <thead> <tr> <th>Printer Mode</th> <th>Description</th> </tr> </thead> <tbody> <tr> <td>None</td> <td>Next label top of form is aligned to the print head burn line location. (Tear Off Mode)</td> </tr> <tr> <td>Cutter Batch</td> <td>Cut the label once at the end of the printing job.</td> </tr> <tr> <td>Cutter Mode</td> <td>Enable the label cutter mode.</td> </tr> <tr> <td>Peeler Mode</td> <td>Enable the label peel off mode.</td> </tr> <tr> <td>Batch Mode</td> <td>Once image is printed completely, label gap/black mark will be fed to the tear plate location for tear away.</td> </tr> </tbody> </table>	Printer Mode	Description	None	Next label top of form is aligned to the print head burn line location. (Tear Off Mode)	Cutter Batch	Cut the label once at the end of the printing job.	Cutter Mode	Enable the label cutter mode.	Peeler Mode	Enable the label peel off mode.	Batch Mode	Once image is printed completely, label gap/black mark will be fed to the tear plate location for tear away.	Batch Mode
Printer Mode	Description													
None	Next label top of form is aligned to the print head burn line location. (Tear Off Mode)													
Cutter Batch	Cut the label once at the end of the printing job.													
Cutter Mode	Enable the label cutter mode.													
Peeler Mode	Enable the label peel off mode.													
Batch Mode	Once image is printed completely, label gap/black mark will be fed to the tear plate location for tear away.													
Offset	This item is used to fine tune media stop location. Available setting value range is from -999 dots to 999 dots.	0 dot												
Shift X	This item is used to fine tune print position. Available setting value range is from -999 dots to 999 dots.	0 dot												
Shift Y		0 dot												
Reference X	This item is used to set the origin of printer coordinate system horizontally and vertically. Available setting range is from 0 dot to 999 dots.	0 dot												
Reference Y		0 dot												
Code page	Use this item to set the code page of international character set.	850												
Country	Use this option to set the country code. Available setting value range is from 1 to 358.	001												

Note: If printing from enclosed software/driver, the software/driver will send out the commands, which will overwrite the settings set from the panel.

6.3.2 ZPL2

This “ZPL2” category can set up the printer settings for ZPL2.

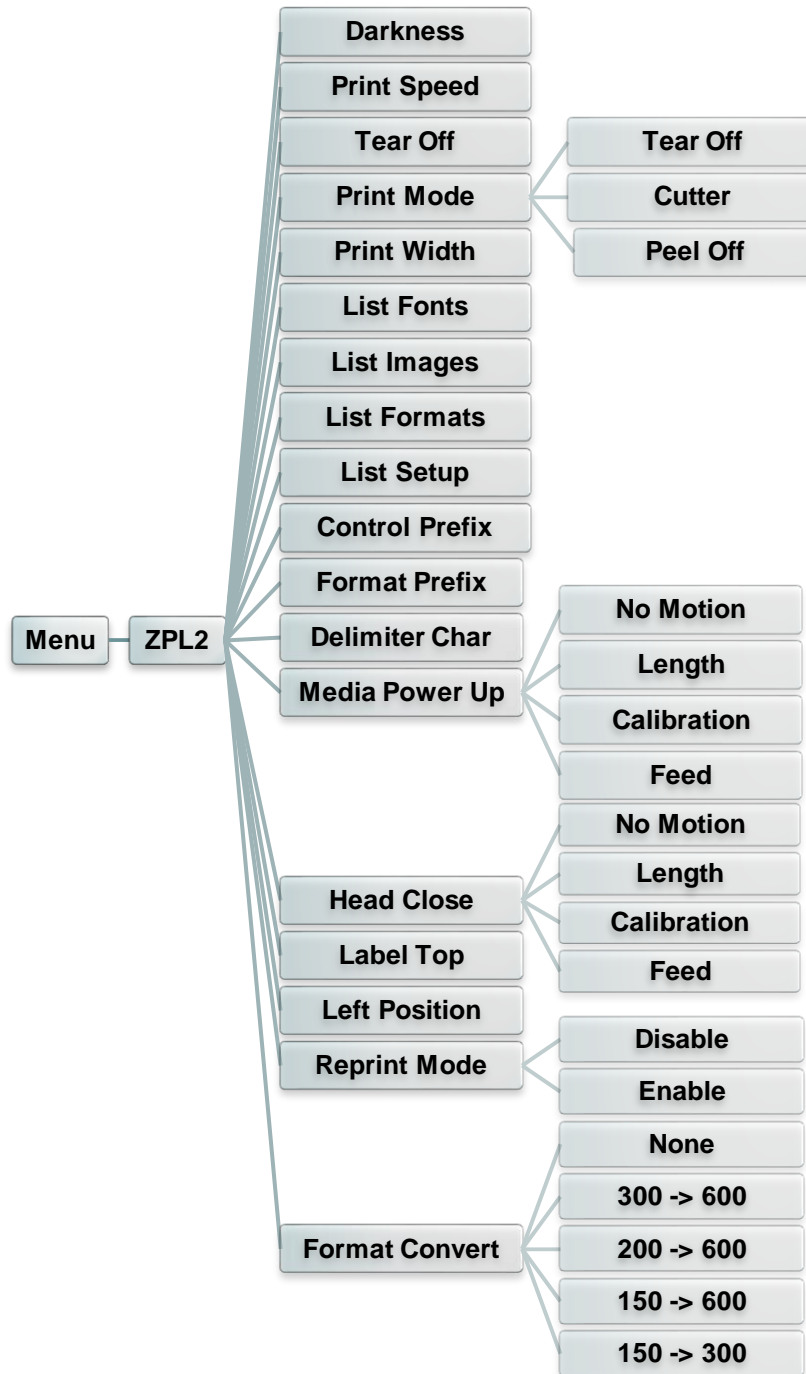

Item	Description	Default
Darkness	Use this item to setup printing darkness. The available setting range is from 0 to 30. You may need to adjust your density based on selected media.	16
Print Speed	Use this item to setup print speed. Available setting range is 1~6 for 203dpi and 1~5 for 300dpi.	203 dpi: 4 300 dpi: 3

Tear Off	This item is used to fine tune media stop location. Available setting value range is from -120~120 dots.	0 dot										
Print mode	<p>This item is used to set the print mode. There are 3 modes as below.</p> <table border="1"> <thead> <tr> <th>Printer Mode</th> <th>Description</th> </tr> </thead> <tbody> <tr> <td>Tear Off</td> <td>Next label top of form is aligned to the print head burn line location.</td> </tr> <tr> <td>Cutter</td> <td>Enable the label cutter mode</td> </tr> <tr> <td>Peel Off</td> <td>Enable the label peel off mode.</td> </tr> </tbody> </table>	Printer Mode	Description	Tear Off	Next label top of form is aligned to the print head burn line location.	Cutter	Enable the label cutter mode	Peel Off	Enable the label peel off mode.	Tear Off		
Printer Mode	Description											
Tear Off	Next label top of form is aligned to the print head burn line location.											
Cutter	Enable the label cutter mode											
Peel Off	Enable the label peel off mode.											
Print Width	This item is used to set print width. The available value range is 2 ~ 1248 dots.	1200										
List Fonts	This feature is used to print current printer available fonts list to the label. The fonts stored in the printer's DRAM, Flash or optional memory card.	N/A										
List Images	This feature is used to print current printer available images list to the label. The images stored in the printer's DRAM, Flash or optional memory card.	N/A										
List Formats	This feature is used to print current printer available formats list to the label. The formats stored in the printer's DRAM, Flash or optional memory card.	N/A										
List Setup	This feature is used to print current printer configuration to the label.	N/A										
Control Prefix	This feature is used to set control prefix character.	N/A										
Format Prefix	This feature is used to set format prefix character.	N/A										
Delimiter Char	This feature is used to set delimiter character.	N/A										
Media Power Up	<p>This option is used to set the action of the media when you turn on the printer.</p> <table border="1"> <thead> <tr> <th>Selections</th> <th>Description</th> </tr> </thead> <tbody> <tr> <td>No Motion</td> <td>Printer will not move media</td> </tr> <tr> <td>Length</td> <td>Printer determine length and feed label</td> </tr> <tr> <td>Calibration</td> <td>Printer will calibration the sensor levels, determine length and feed label</td> </tr> <tr> <td>Feed</td> <td>Printer will advance one label</td> </tr> </tbody> </table>	Selections	Description	No Motion	Printer will not move media	Length	Printer determine length and feed label	Calibration	Printer will calibration the sensor levels, determine length and feed label	Feed	Printer will advance one label	No Motion
Selections	Description											
No Motion	Printer will not move media											
Length	Printer determine length and feed label											
Calibration	Printer will calibration the sensor levels, determine length and feed label											
Feed	Printer will advance one label											
Head Close	<p>This option is used to set the action of the media when you close the print head.</p> <table border="1"> <thead> <tr> <th>Selections</th> <th>Description</th> </tr> </thead> <tbody> <tr> <td>No Motion</td> <td>Printer will not move media</td> </tr> <tr> <td>Length</td> <td>Printer determine length and feed label</td> </tr> <tr> <td>Calibration</td> <td>Printer will calibrate the sensor levels, determine length and feed label</td> </tr> <tr> <td>Feed</td> <td>Printer will advance one label</td> </tr> </tbody> </table>	Selections	Description	No Motion	Printer will not move media	Length	Printer determine length and feed label	Calibration	Printer will calibrate the sensor levels, determine length and feed label	Feed	Printer will advance one label	No Motion
Selections	Description											
No Motion	Printer will not move media											
Length	Printer determine length and feed label											
Calibration	Printer will calibrate the sensor levels, determine length and feed label											
Feed	Printer will advance one label											
Label Top	This option is used to adjust print position vertically on the label. The range is -120 to +120 dots.	0										
Left Position	This option is used to adjust print position horizontally on the label. The range is -9999 to +9999 dots.	0										
Reprint Mode	When reprint mode is enabled, you can reprint the last label printer by pressing  button on printer's control panel.	Disable										

Format Convert	Selects the bitmap scaling factor. The first number is the original dots per inch (dpi) value; the second, the dpi to which you would like to scale.	None
-----------------------	--	-------------

Note: If printing from enclosed software/driver, the software/driver will send out the commands, which will overwrite the settings set from the panel.

6.4 Sensor

This option is used to calibrate the selected sensor. We recommend calibrate the sensor before printing when changing the media.

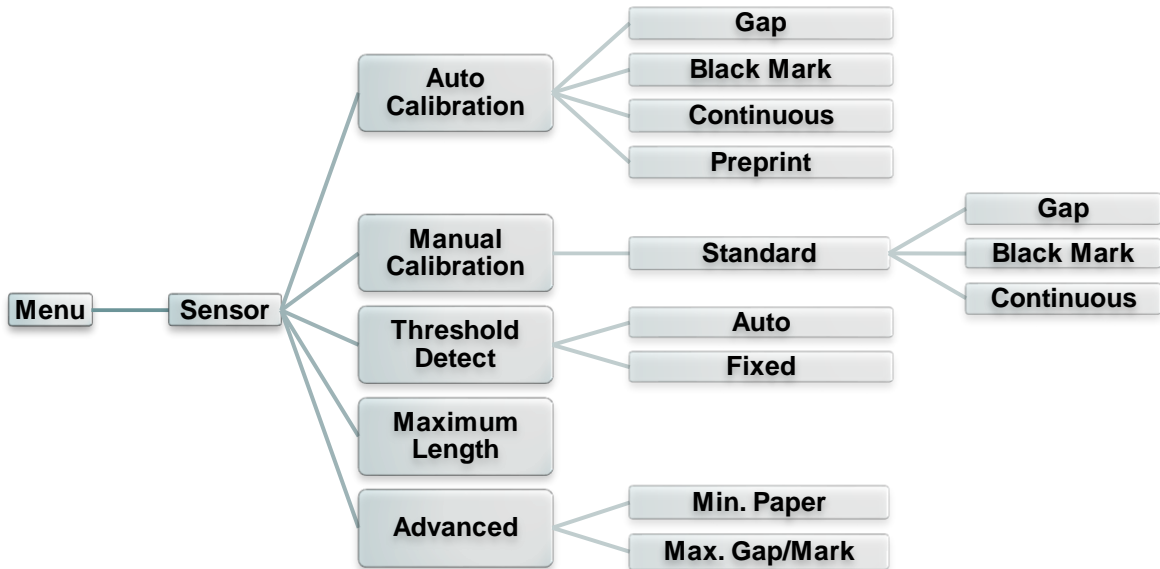

Item	Description	Default
Auto Calibration	This option is used to set the media sensor type and calibrate the selected sensor automatically. Printer will feed 2 to 3 gap labels to calibrate the sensor sensitivity automatically.	N/A
Manual setup	In case “Automatic” cannot apply to the media, please use “Manual” function to set the paper length and gap/bline size then scan the backing/mark to calibrate the sensor sensitivity. Note: The “Media Capacity” item is used to calibrate the media capacity sensor %.	N/A
Threshold Detect	This option is used to set sensor sensitivity in fixed or auto.	Auto
Maximum Length	This option is used to set the maximum length for label calibration.	254 mm
Advanced	This function can set the minimum paper length and maximum gap/bline length for auto-calibrate the sensor sensitivity.	0 mm

6.5 Interface

This option is used to set the printer interface settings.

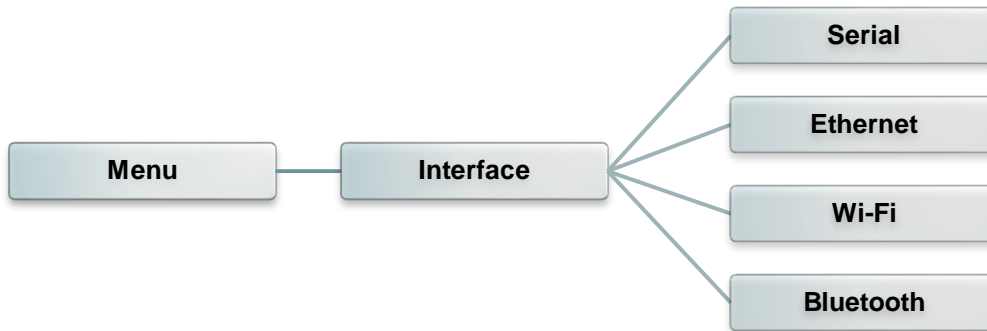

6.5.1 Serial Comm.

This option is used to set the printer RS-232 settings.

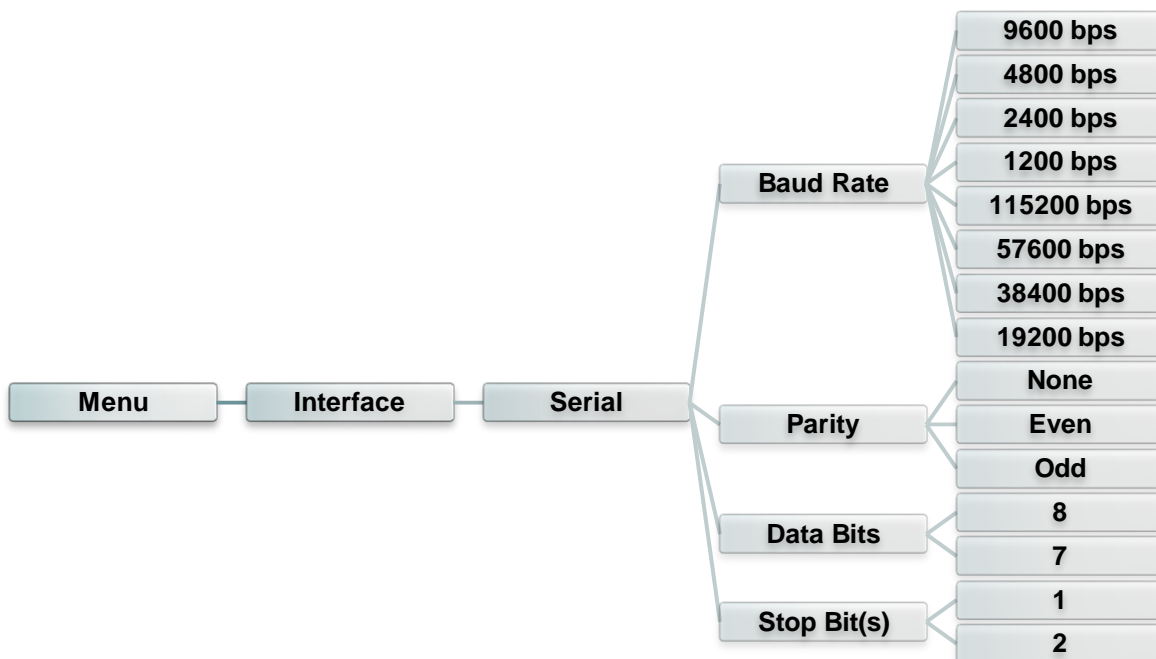

Item	Description	Default
Baud Rate	This item is used to set the RS-232 baud rate.	9600
Parity	This item is used to set the RS-232 parity.	None
Data Bits	This item is used to set the RS-232 Data Bits.	8
Stop Bit(s)	This item is used to set the RS-232 Stop Bits.	1

6.5.2 Ethernet

Use this menu to configure internal Ethernet configuration, check the printer's Ethernet module status, and reset the Ethernet module.

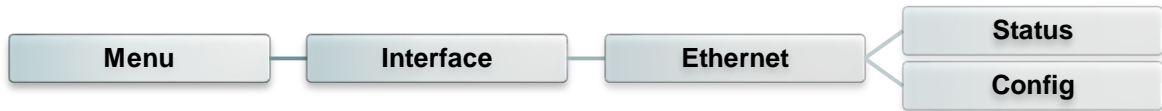

Item	Description	Default
Status	Use this menu to check the Ethernet IP address and MAC setting status.	N/A
Config.	DHCP: This item is used to ON or OFF the DHCP (Dynamic Host Configuration Protocol) network protocol. Static IP: Use this menu to set the printer's IP address, subnet mask and gateway.	DHCP

6.5.3 Wi-Fi

This option is used to set the printer Wi-Fi settings.

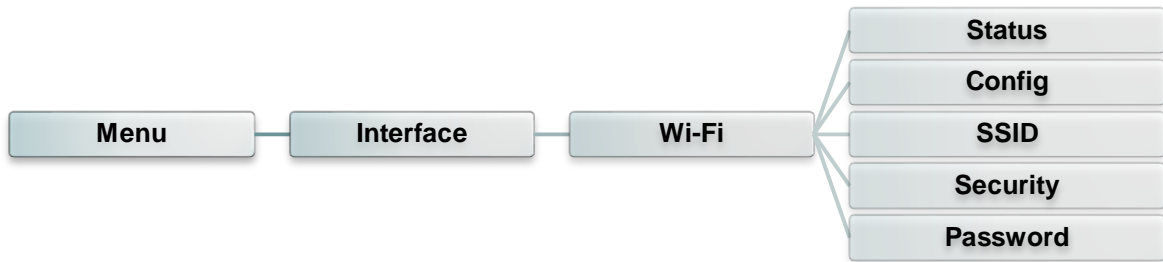

Item	Description	Default
Status	Use this menu to check the Wi-Fi IP address, MAC setting status....	N/A
Config.	<p>DHCP: This item is used to ON or OFF the DHCP (Dynamic Host Configuration Protocol) network protocol.</p> <p>Static IP: Use this menu to set the printer's IP address, subnet mask and gateway.</p>	DHCP
SSID	Use this menu to set the Wi-Fi SSID	N/A
Security	Use this menu to set the Wi-Fi security	Open
Password	Use this menu to set the Wi-Fi password	N/A

6.5.4 Bluetooth

This option is used to set the printer Bluetooth settings.

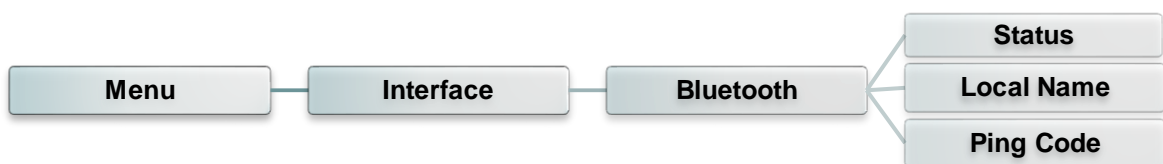

Item	Description	Default
Status	Use this menu to check the Bluetooth status.	N/A
Local Name	This item is used to set the local name for Bluetooth.	RF-BHS
Ping Code	This item is used to set the local ping code for Bluetooth.	0000

6.6 Advanced

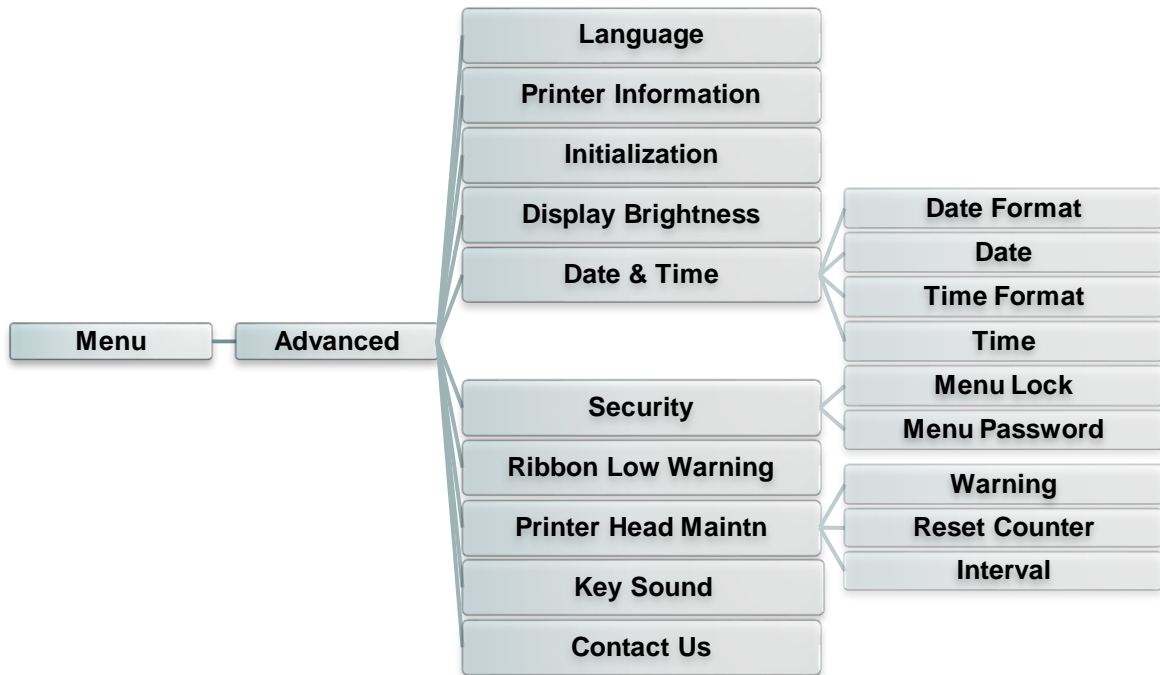

Item	Description	Default
Language	This item is used to setup the language on display.	English
Printer Information	This feature is used to check the printer serial number, printed mileage (m), printed labels (pcs) and cutting counter.	N/A
Initialization	This feature is used to restore printer settings to defaults.	N/A
Display Brightness	This item is used to setup the brightness for display. (Range 0~100)	50
Date & Time	This item is used to setup the date and time on display.	N/A
Security	This feature is used to set the password for locking the menu or favorites. The default password is 8888.	Disable
Ribbon Low Warning	This item is used to set the warning for ribbon low %. For example, if setting value is 10%, when ribbon capacity was lower than 10%, the  % will be shown in red.	10%

Printer Head Maintn	This item is used to check print head status and to set the settings for print head care.		N/A
	Item	Description	
	Warning	This item is used to enable/disable the print head clean warning. If enable this feature, once print head has been reached the setting mileage then the warning icon will be shown on printer UI for reminding user to clean the print head. The default setting is disable.	
	Reset Counter	This item is used to reset the print head clean warning mileage after cleaned print head.	
	Interval	This item is used to set the expected mileage for reminding user to clean the print head. You have to enable the “TPH warning lock” for use. The default setting is 1 km.	
Key Sound	This item is used to open/close the key sound.		ON
Contact us	This feature is used to check the contact information for tech support service		N/A

6.7 File Manager

This feature is used to check the printer available memory, show the files list, delete the files or run the files that saved in the printer DRAM/Flash memory.

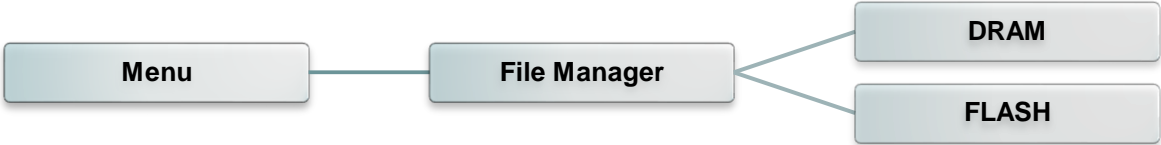

6.8 Diagnostic

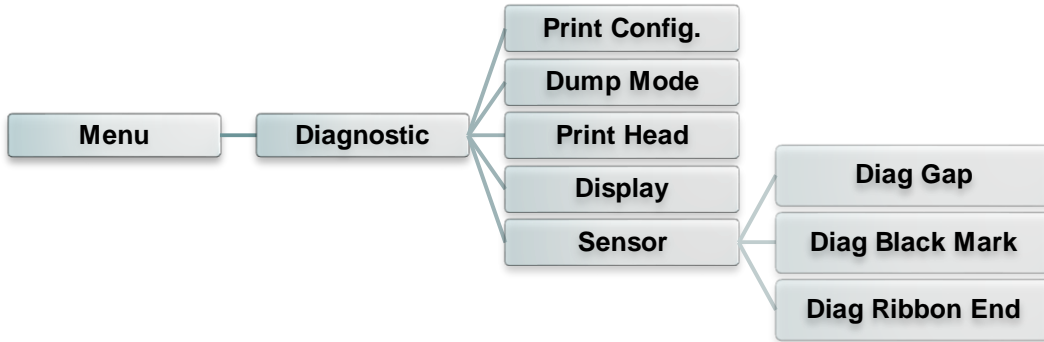

Item	Description
<p>Print Config.</p>	<p>This feature is used to print current printer configuration to the label. On the configuration printout, there is a print head test pattern, which is useful for checking if there is any dot damage on the print head heater element.</p> <div style="border: 1px solid black; padding: 10px; margin: 10px 0;"> <p style="text-align: center; background-color: #e0f2f1;">Self-test printout</p> <pre> ----- SYSTEM INFORMATION ----- MODEL: XXXXXX FIRMWARE: X.XX CHECKSUM: XXXXXXXX S/N: XXXXXXXXXXXX TCF: NO DATE: 1970/01/01 TIME: 00:04:18 NON-RESET: 110 m (TPH) RESET: 110 m (TPH) NON-RESET: 0 (CUT) RESET: 0 (CUT) ----- PRINTING SETTING ----- SPEED: 5 IPS DENSITY: 8.0 WIDTH: 4.00 INCH HEIGHT: 4.00 INCH GAP: 0.00 INCH INTENSION: 5 CODEPAGE: 850 COUNTRY: 001 ----- Z SETTING ----- DARKNESS: 16.0 SPEED: 4 IPS WIDTH: 4.00 INCH TILDE: 7EH (~) CARET: 5EH (^) DELIMITER: 2CH (,) POWER UP: NO MOTION HEAD CLOSE: NO MOTION ----- RS232 SETTING ----- BAUD: 9600 PARITY: NONE DATA BIT: 8 STOP BIT: 1 ----- </pre> <p style="text-align: right; margin-top: 10px;">Note: ZPL is emulating for Zebra® language.</p> </div>

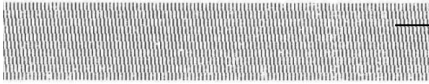
	<pre> ----- DRAM FILE (0 FILES) ----- PHYSICAL XXXX KBYTES AVAILABLE XXXX KBYTES ----- FLASH FILE (0 FILES) ----- PHYSICAL XXXX KBYTES AVAILABLE XXXX KBYTES ----- </pre>	<p>Numbers of download files Total & available memory space</p>
		<p>Print head check pattern</p> <p>Note: Checking dot damage requires 4" wide paper width.</p>

Dump Mode	<p>Captures the data from the communications port and prints out the data received by printer. In the dump mode, all characters will be printed in 2 columns. The left side characters are received from your system and right side data are the corresponding hexadecimal value of the characters. It allows users or engineers to verify and debug the program.</p>	
	<div style="border: 1px solid black; padding: 10px; width: fit-content; margin: auto;"> <pre> DOWNLOA 0D 0A 44 4F 57 4E 4C 4F 4I D „TEST2. 44 20 22 54 45 53 54 32 2E DAT“,5,CL 44 41 54 22 2C 35 2C 43 4C S DOWNLO 53 0D 0A 44 4F 57 4E 4C 4F AD F,„TES 41 44 20 46 2C 22 54 45 53 T4.DAT“,5 54 34 2E 44 41 54 22 2C 35 ,CLS DOW 2C 43 4C 53 0D 0A 44 4F 57 NLOAD „TE 4E 4C 4F 41 44 20 22 54 45 ST2.DAT“, 53 54 32 2E 44 41 54 22 2C 5,CLS DO 35 2C 43 4C 53 0D 0A 44 4F WNLOAD F, 57 4E 4C 4F 41 44 20 46 2C „TEST4.DA 22 54 45 53 54 34 2E 44 41 T“,5,CLS 54 22 2C 35 2C 43 4C 53 0D DOWNLOAD 0A 44 4F 57 4E 4C 4F 41 44 „TEST2.D 20 22 54 45 53 54 32 2E 44 AT“,5,CLS 41 54 22 2C 35 2C 43 4C 53 DOWNLOA 0D 0A 44 4F 57 4E 4C 4F 4I D F,„TEST 44 20 46 2C 22 54 45 53 54 4.DAT“,5, 34 2E 44 41 54 22 2C 35 2C CLS 43 4C 53 0D 0A </pre> </div> <p>ASCII Data ←</p> <p style="text-align: right;">Hexadecimal data related to left column of ASCII data</p>	
	<p>Note: Dump mode requires 4" wide paper width.</p>	

Print Head	This feature is used to check print head's temperature and bad dots.
Display	This feature is used to check LCD's color state.
Sensor	This feature is used to check sensors intensity and reading state.

6.9 Favorites

This feature is used to create your own favorites list. You can organize the commonly used setting options in “Favorites”.

- **Select “Favorites” list**

Touch and hold left select key, the “Favorites” list will pop up.

Note: If the main menu button with locked sign, please input password to unlock the screen.

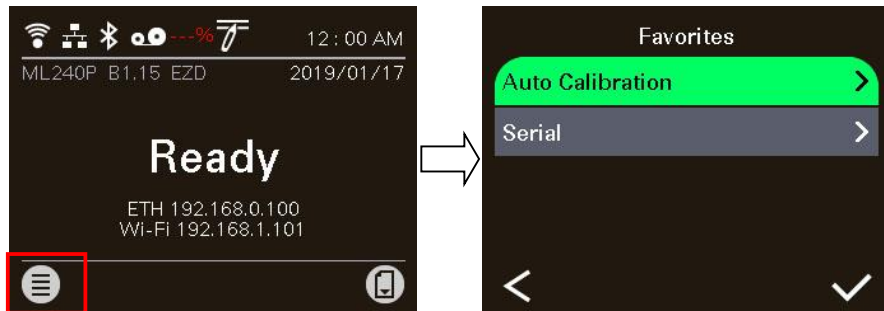

- **Get organized “Favorites” list**

Choose and hold a favorite option item by left select key, until “Join Favorites” setting screen pops up. Select “Yes” to add this setting option item to “Favorites”.

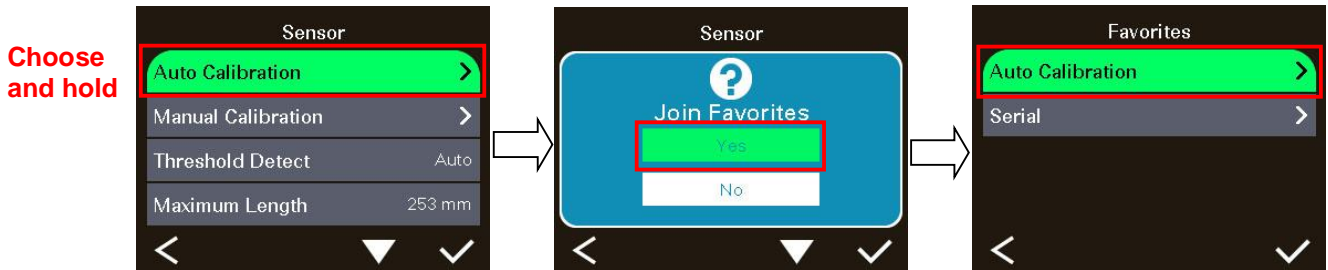

- **Delete favorites item**

Choose and hold the option item by right select key, until “Delete Favorites” setting screen pops up. Select “Yes” to delete this setting option item on “Favorites”.

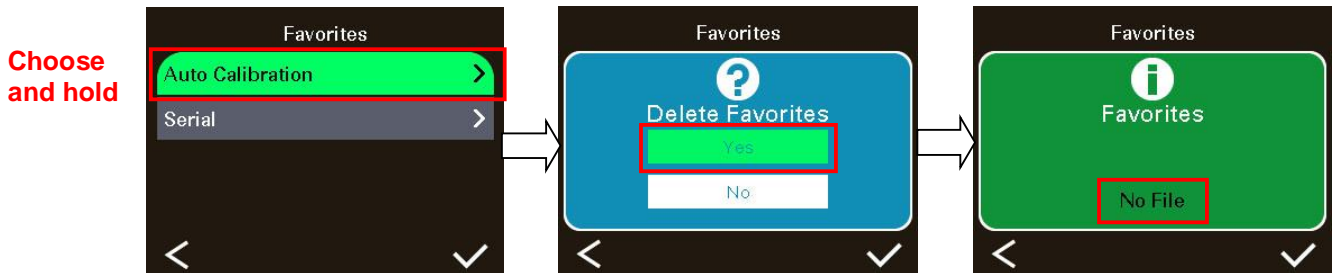

7. Troubleshooting

The following guide lists the most common problems that may be encountered when operating this bar code printer. If the printer still does not function after all suggested solutions have been invoked, please contact the Customer Service Department of your purchased reseller or distributor for assistance.

Problem	Possible Cause	Recovery Procedure
Power indicator does not illuminate	<ul style="list-style-type: none"> * The power cord is not properly connected. * The power switch is closed. 	<ul style="list-style-type: none"> * Plug the power cord in printer and outlet. * Switch the printer on.
Carriage Open	<ul style="list-style-type: none"> * The printer carriage is open. 	<ul style="list-style-type: none"> * Please close the print carriage.
Not Printing	<ul style="list-style-type: none"> * Check if interface cable is well connected to the interface connector. * Check if Bluetooth device is well connected between host and printer. * The port specified in the Windows driver is not correct. 	<ul style="list-style-type: none"> * Re-connect cable to interface or change a new cable. * Please reset the wireless device setting. * Select the correct printer port in the driver. * Clean the printhead. * Printhead's harness connector is not well connected with printhead. Turn off the printer and plug the connector again. * Check your program if there is a command PRINT at the end of the file and there must have CRLF at the end of each command line.
No print on the label	<ul style="list-style-type: none"> * Label or ribbon is loaded not correctly. * Use wrong type paper or ribbon 	<ul style="list-style-type: none"> * Follow the instructions in loading the media and ribbon. * Ribbon and media are not compatible. * Verify the ribbon-inked side. * The print density setting is incorrect.
No Ribbon	<ul style="list-style-type: none"> * Running out of ribbon. * The ribbon is installed incorrectly. 	<ul style="list-style-type: none"> * Supply a new ribbon roll. * Please refer to the steps in user's manual to reinstall the ribbon.
No Paper	<ul style="list-style-type: none"> * Running out of label. * The label is installed incorrectly. * Gap/black mark sensor is not calibrated. 	<ul style="list-style-type: none"> * Supply a new label roll. * Please refer to the steps in user's manual to reinstall the label roll. * Calibrate the gap/black mark sensor.
Paper Jam	<ul style="list-style-type: none"> * Gap/black mark sensor is not set properly. * Make sure label size is set properly. * Labels may be stuck inside the printer mechanism. 	<ul style="list-style-type: none"> * Calibrate the media sensor. * Set media size correctly. * Remove the stuck label inside the printer mechanism.
Take Label	<ul style="list-style-type: none"> * Peel function is enabled. 	<ul style="list-style-type: none"> * If the peeler module is installed, please remove the label. * If there is no peeler module in front of the printer, please switch off the printer and install it. * Check if the connector is plugging correctly.
Can't downloading the file to memory (FLASH / DRAM)	<ul style="list-style-type: none"> * The space of memory is full. 	<ul style="list-style-type: none"> * Delete unused files in the memory.

Poor Print Quality	<ul style="list-style-type: none"> * Ribbon and media is loaded incorrectly * Dust or adhesive accumulation on the print head. * Print density is not set properly. * Printhead element is damaged. * Ribbon and media are incompatible. * The printhead pressure is not set properly. 	<ul style="list-style-type: none"> * Reload the supply. * Clean the print head. * Clean the platen roller. * Adjust the print density and print speed. * Run printer self-test and check the print head test pattern if there is dot missing in the pattern. * Change proper ribbon or proper label media. * Adjust the printhead pressure adjustment knob. * The release lever does not latch the printhead properly.
Missing printing on the left or right side of label	<ul style="list-style-type: none"> * Wrong label size setup. 	<ul style="list-style-type: none"> * Set the correct label size.
Gray line on the blank label	<ul style="list-style-type: none"> * The print head is dirty. * The platen roller is dirty. 	<ul style="list-style-type: none"> * Clean the print head. * Clean the platen roller. (Please refer to chapter 8)
Irregular printing	<ul style="list-style-type: none"> * The printer is in Hex Dump mode. 	<ul style="list-style-type: none"> * Turn off and on the printer to skip the dump mode.
Label feeding is not stable (skew) when printing	<ul style="list-style-type: none"> * The media guide does not touch the edge of the media. 	<ul style="list-style-type: none"> * If the label is moving to the right side, please move the label guide to left. * If the label is moving to the left side, please move the label guide to right.
Skip labels when printing	<ul style="list-style-type: none"> * Label size is not specified properly. * Sensor sensitivity is not set properly. * The media sensor is covered with dust. 	<ul style="list-style-type: none"> * Check if label size is setup correctly. * Calibrate the sensor by Auto Gap or Manual Gap options. * Clear the GAP/Black mark sensor by blower.
Wrinkle Problem	<ul style="list-style-type: none"> * Printhead pressure is incorrect. * Ribbon installation is incorrect. * Media installation is incorrect. * Print density is incorrect. * Media feeding is incorrect. 	<ul style="list-style-type: none"> * Please refer to the chapter 4. * Please set the suitable density to have good print quality. * Make sure the label guide touch the edge of the media guide.
The left side printout position is incorrect	<ul style="list-style-type: none"> * Wrong label size setup. * The parameter Shift X in LCD menu is incorrect. 	<ul style="list-style-type: none"> * Set the correct label size. * Press [Menu] → [Setting] → [Shift X] to fine tune the parameter of Shift X.

The printing position of small label is incorrect

- * Media sensor sensitivity is not set properly.
- * Label size is incorrect.
- * The parameter Shift Y in the LCD menu is incorrect.
- * The vertical offset setting in the driver is incorrect.

- * Calibrate the sensor sensitivity again.
- * Set the correct label size and gap size.
- * Press [Menu] → [Setting] → [Shift Y] → to fine tune the parameter of Shift Y.
- * If using the software BarTender, please set the vertical offset in the driver.

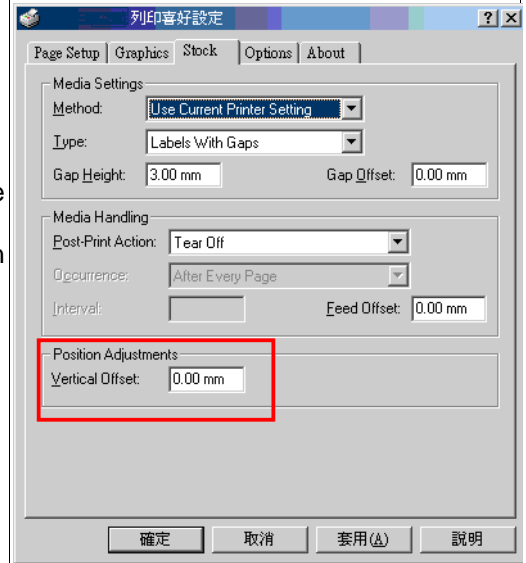

8. Maintenance

This session presents the clean tools and methods to maintain your printer.

1. Please use one of following material to clean the printer.

- Cotton swab
- Lint-free cloth
- Vacuum / Blower brush
- 100% Ethanol or Isopropyl Alcohol

2. The cleaning process is described as following,

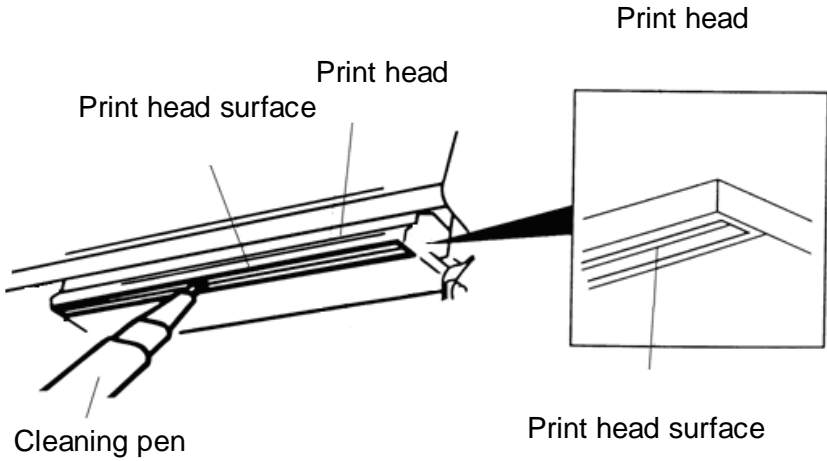
Printer Part	Method	Interval
Print Head	1. Always turn off the printer before cleaning the print head. 2. Allow the print head to cool for a minimum of one minute. 3. Use a cotton swab and 100% Ethanol or Isopropyl Alcohol to clean the print head surface.	Clean the print head when changing a new label roll.
	 <p>The diagram illustrates the cleaning process of the print head. It shows a side view of the print head assembly with a cleaning pen being used to clean the print head surface. Labels include 'Print head surface', 'Print head', and 'Cleaning pen'. An inset box provides a close-up view of the 'Print head surface'.</p>	
Platen Roller	1. Turn the power off. 2. Rotate the platen roller and wipe it thoroughly with water.	Clean the platen roller when changing a new label roll
Peel Bar	Use the lint-free cloth with 100% ethanol to wipe it.	As needed
Sensor	Compressed air or vacuum	Monthly
Exterior	Wipe it with water-dampened cloth	As needed
Interior	Brush or vacuum	As needed

Note:

- Do not touch printer head by hand. If you touch it carelessly, please use ethanol to clean it.
- Please use 100% Ethenol or Isopropyl Alcohol. DO NOT use medical alcohol, which may damage the printer head.
- Regularly clean the print head and supply sensors once change a new media to keep printer performance and extend printer life.

Revise History

Date	Content	Editor
2019/3/28	Modify Ch.1.2.1 internal Ethernet interface of ML240P/ ML340P to Internal Ethernet print server (10/100 Mbps)	Kate
2019/4/17	Add Ch.1.2.2 User option (Cutter tray) for ML240P/ ML340P	Kate
2019/5/13	Modify Ch.1.2.2 Regular guillotine cutter module spec	Kate
2019/7/30	Add Ch.1.4 Max. print length of ML240P and ML340P Series	Kate
2019/8/8	Modify Ch.1.3 Environmental condition of ML240P and ML340P Series	Kate
2019/10/18	Modify Ch.1.2.2 Printer Optional Features from Internal Bluetooth 4.2 module in front panel to Internal Bluetooth 4.2 MFi module in front panel	Kate
2019/10/21	Add Agency Compliance and Approvals (MFi for Bluetooth)	Kate
2019/12/10	Modify Ch.1.2.2 Printer Optional Features Internal Bluetooth 4.2 MFi module in front panel to factory option on ML240/ ML240P Series	Kate



TSC Auto ID Technology Co., Ltd.

Corporate Headquarters

9F., No.95, Minquan Rd., Xindian Dist.,
New Taipei City 23141, Taiwan (R.O.C.)

TEL: +886-2-2218-6789

FAX: +886-2-2218-5678

Web site: www.tscprinters.com

E-mail: apac_sales@tscprinters.com
tech_support@tscprinters.com

Li Ze Plant

No.35, Sec. 2, Ligong 1st Rd., Wujie Township,
Yilan County 26841, Taiwan (R.O.C.)

TEL: +886-3-990-6677

FAX: +886-3-990-5577